

# TV Stand

BL-FTXF01-BK

BL-FTXF01-WH

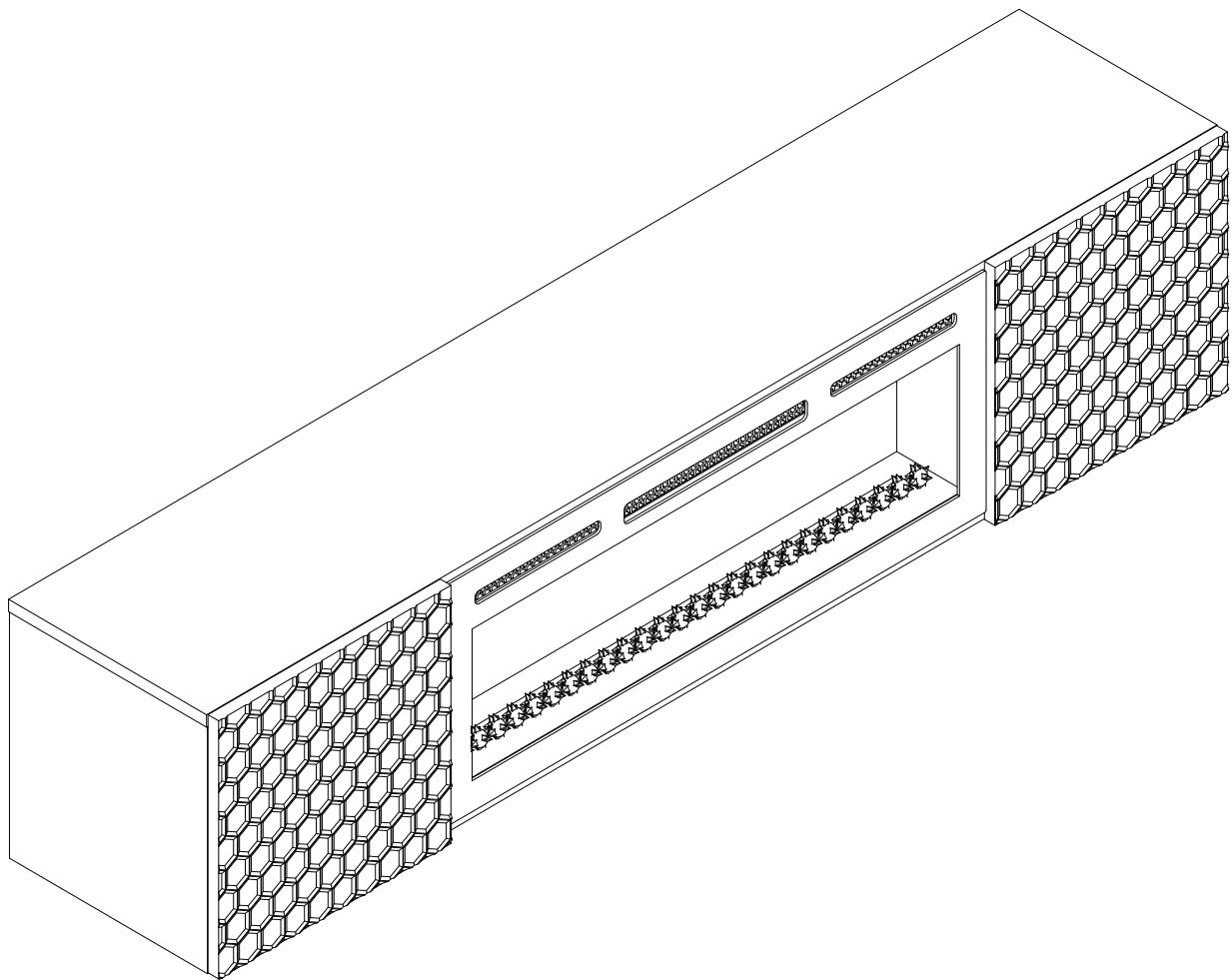

Important-Please read these instructions fully before starting assembly

Web:[www.boyelliving.com](http://www.boyelliving.com)

Service Contact:[service@boyelliving.com](mailto:service@boyelliving.com)

Phone Number: (909) 297-5794/ (323) 982-8955

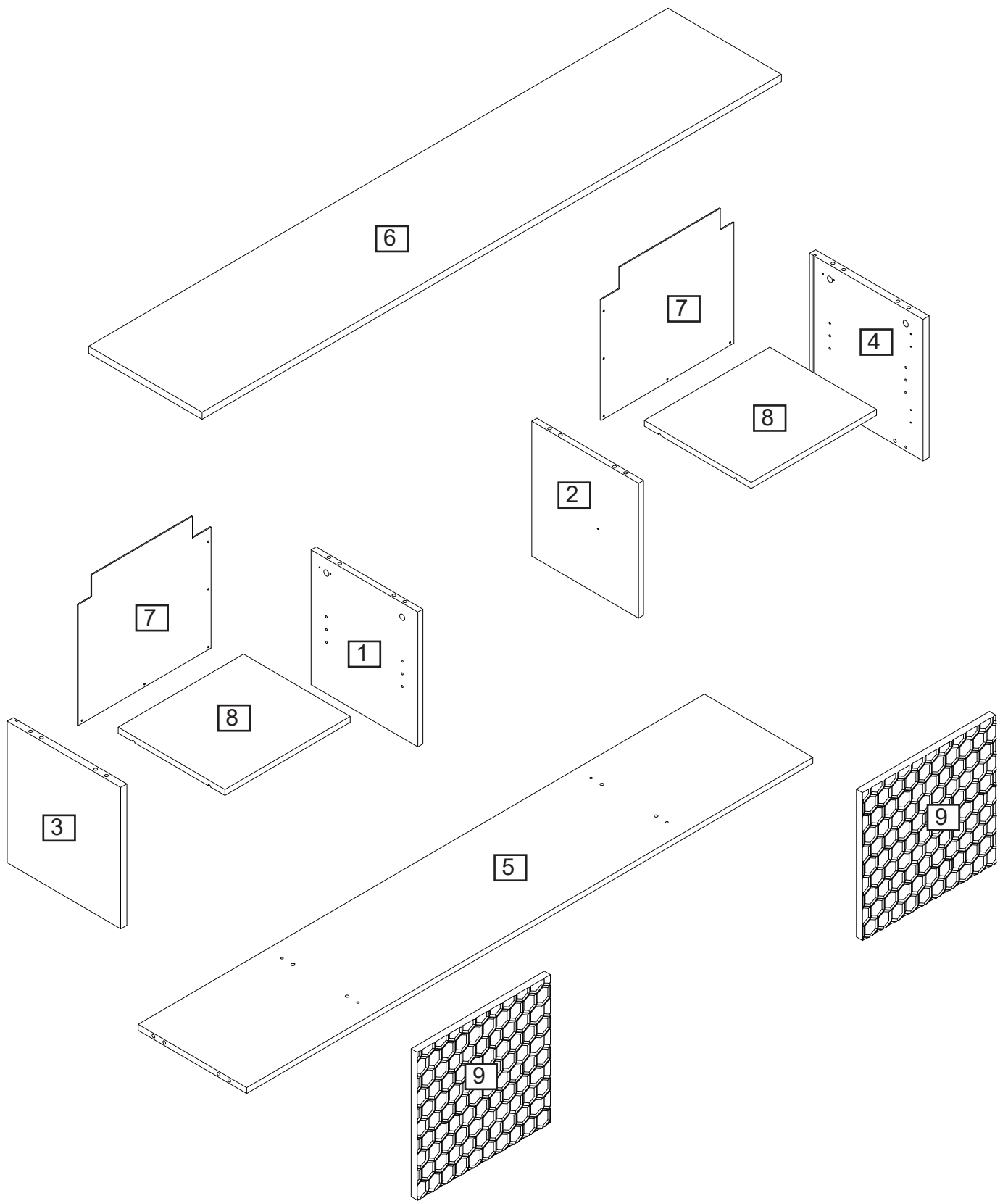

# ASSEMBLY INSTRUCTIONS

## Part List:

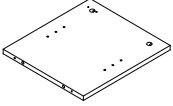
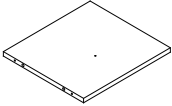
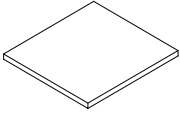
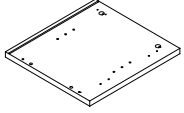
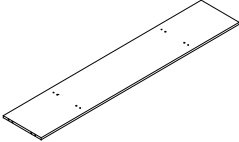
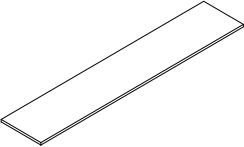
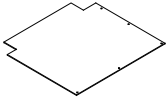



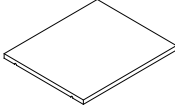
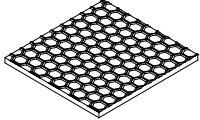









ITEM	DESCRIPTION	PART	QTY
1	Left central panel		1
2	Right central panel		1
3	Left panel		1
4	Right panel		1
5	Bottom panel		1
6	Top panel		1
7	Backboard		2

## Part List:

ITEM	DESCRIPTION	PART	QTY
8	Active plate		2
9	Door		2

# ASSEMBLY INSTRUCTIONS

## Hardware List:

ITEM	DESCRIPTION	PART	QTY
A	7*43mm Male Camlock		12
B	Female Camlock		12
C	8*30mm Dowel		16
D	3.5*14mm Screw		20
E	5*40mm Screw		4
F	4*12mm Screw		8
G	Wall attach bracket		2
H	Wall attach bracket		2
I	Metal cleat		4
J	Wall fixing pack		8
K	Hinge		4
L	Adjustable Support Cap		8
M	3*14mm Screw		10
N	Push-open Latch		2
O	3.5*14mm Screw		2

# Using Camlocks

## Step 1

Connect the male camlock as directed in the assembly instructions using a screwdriver.

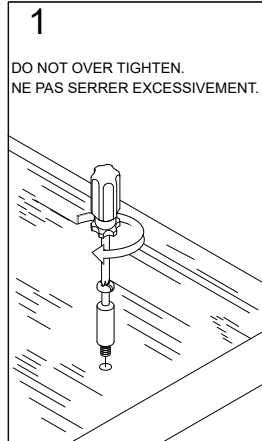

## Step 2

Push the male camlock into the entry hole.

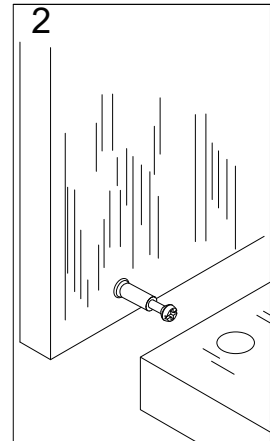

## Step 3

Insert the female camlock as shown in the instructions.

Note: ensure that the arrow on the top of the camlock points towards the entry hole for the male camlock.

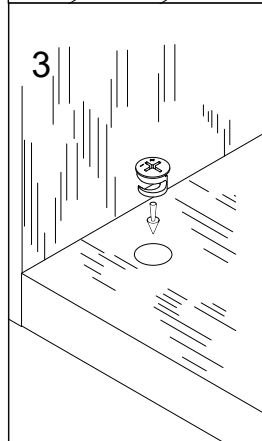

## Step 4

Turn the female camlock clockwise with a screwdriver.

You should feel a click when the camlock is locked in place.

The joint is now secure.

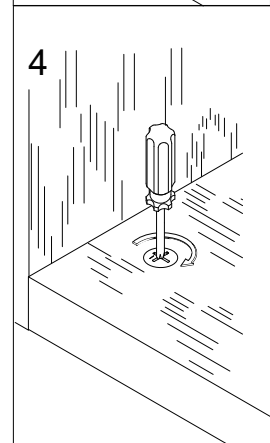

# Adjusting Hinges

## Hinge adjustment:

a: To move the top panel up or down, loosen screws shown and move top panel to suit

b: To move the top panel in or out, loosen screws shown and move top panel to suit.

Retighten screws

c: To move the top panel left or right, adjust screws shown.

a:

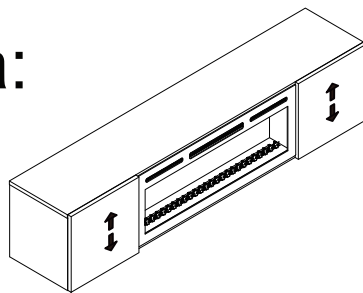

b:

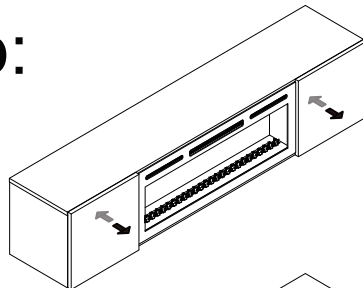

c:

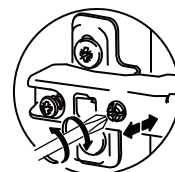
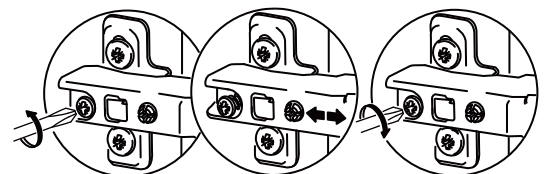
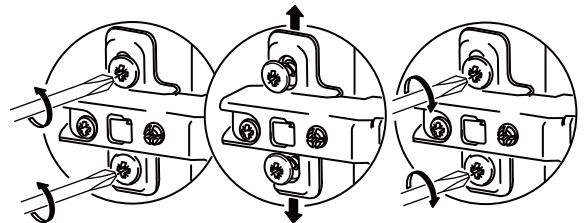
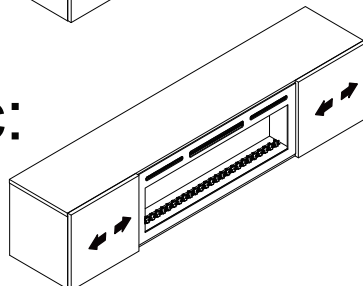

# 1

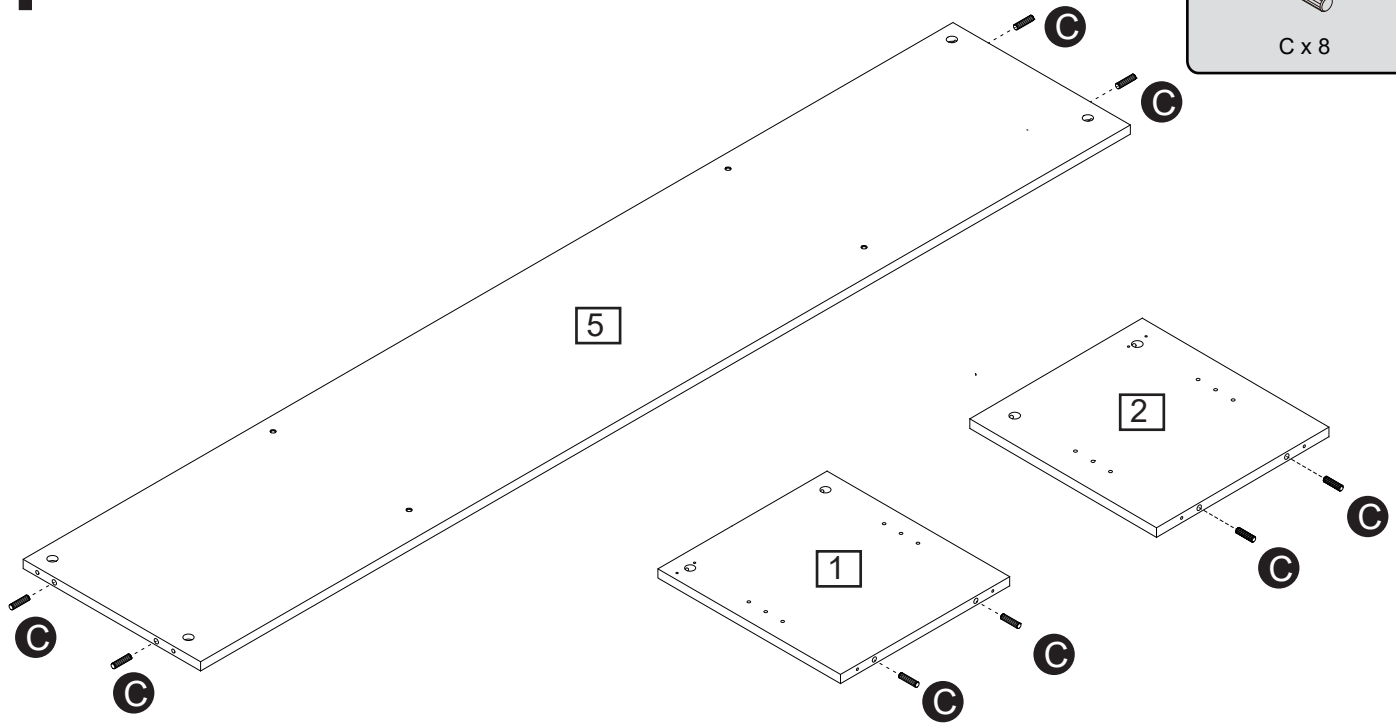

# 2

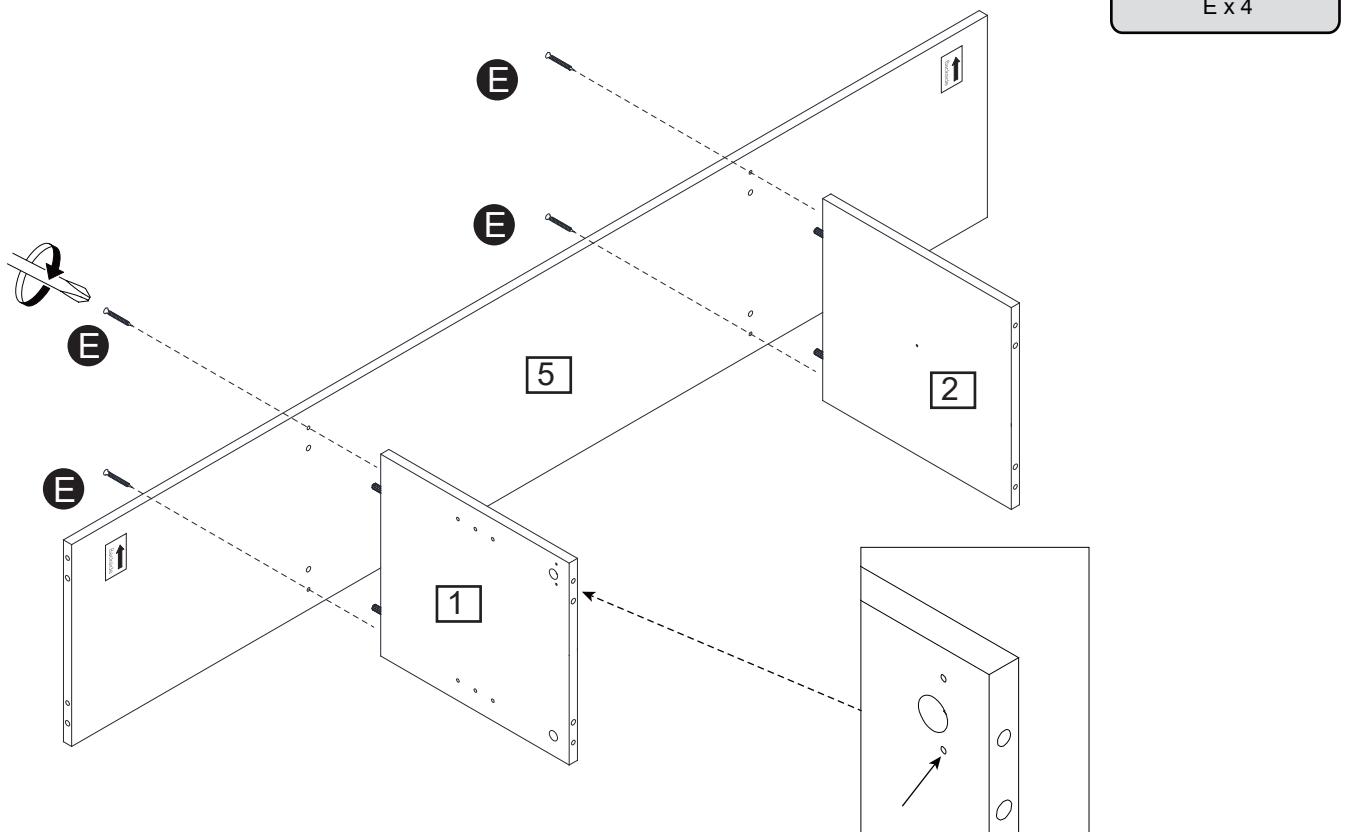

# 3

## CAM-LOCK

Tighten until shoulder is flush with panel. Do not overtighten or undertighten (see example below)

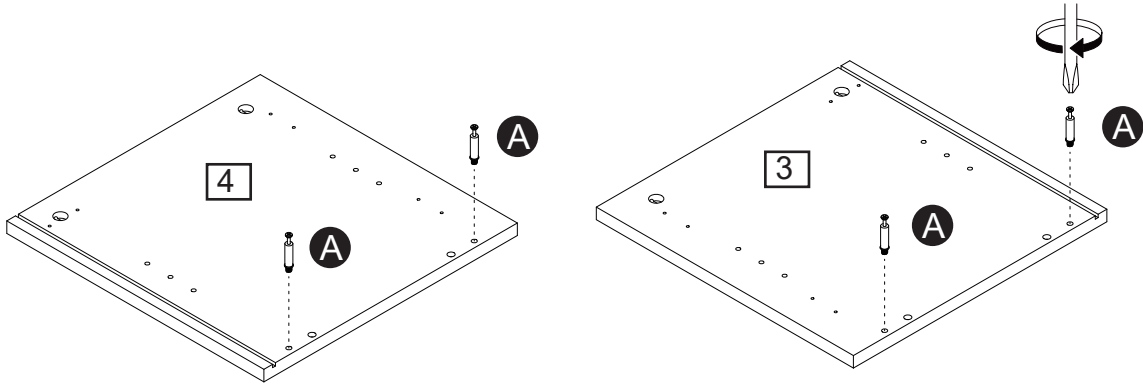
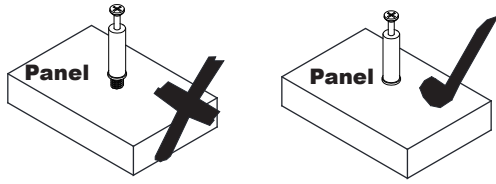
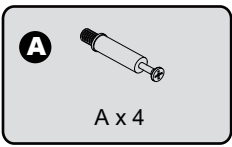
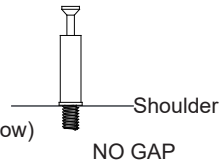

# 4

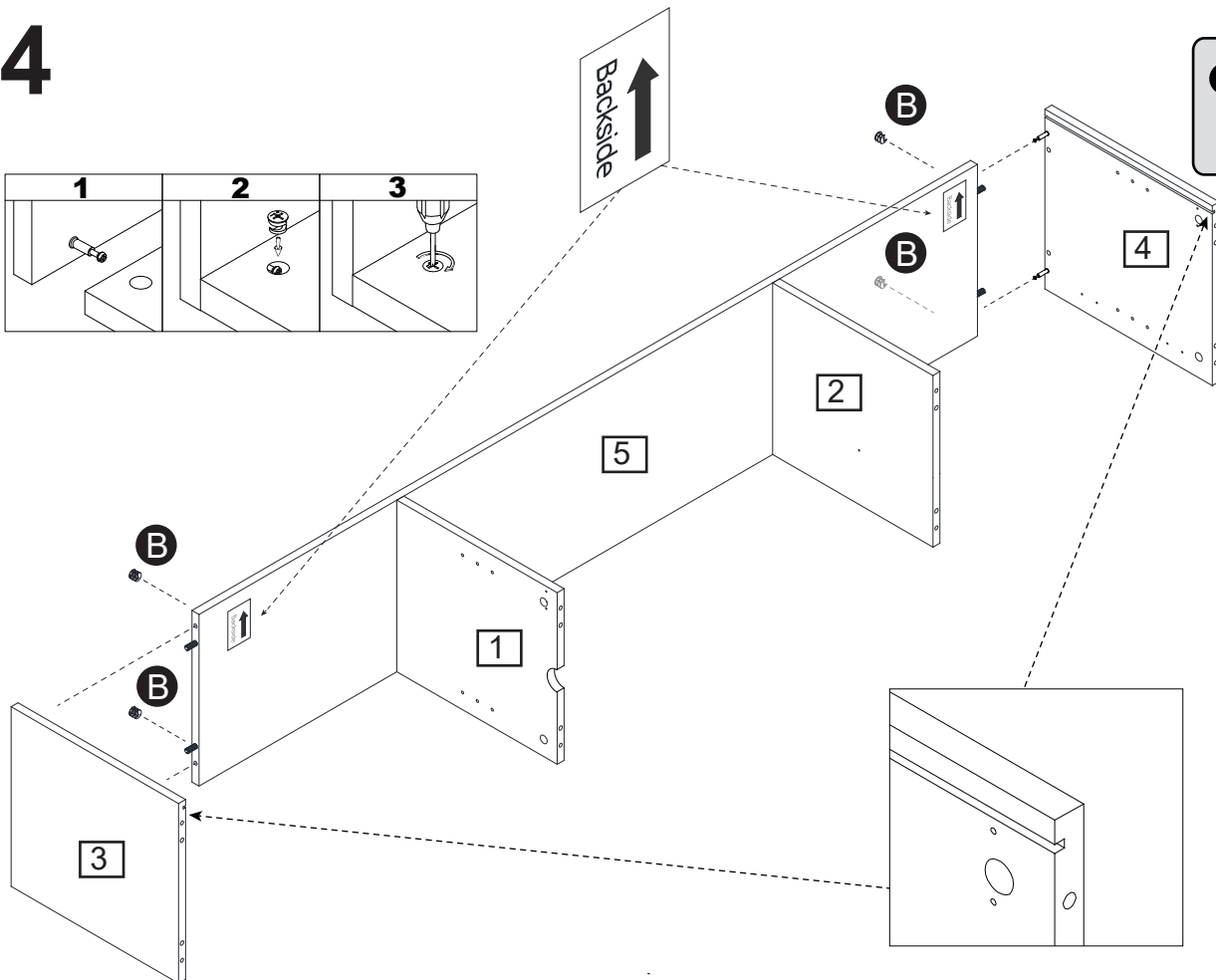
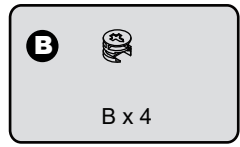

# 5

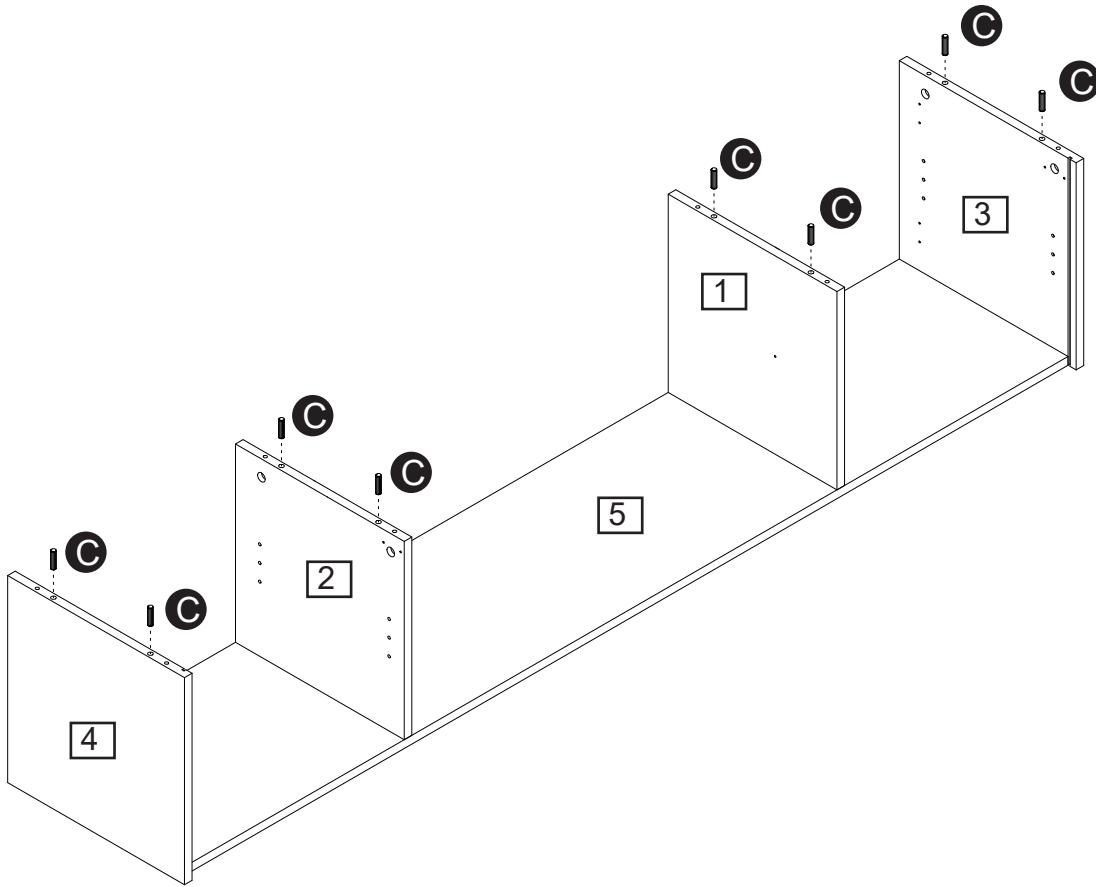
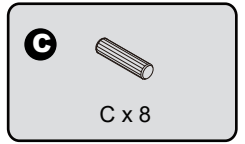

# 6

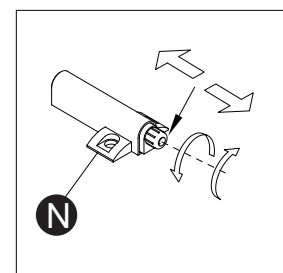
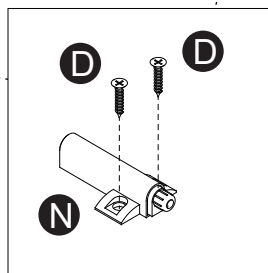
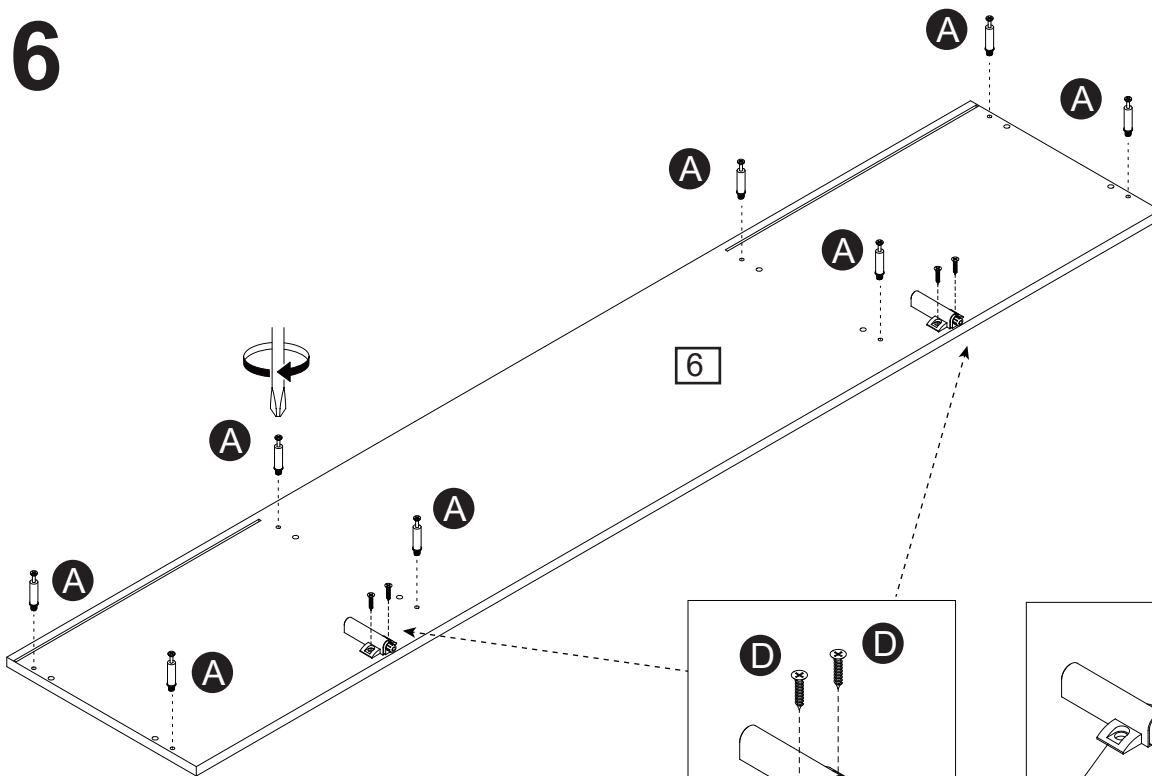
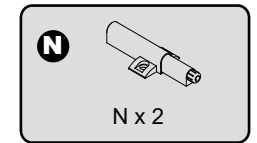
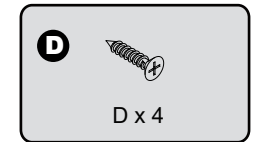
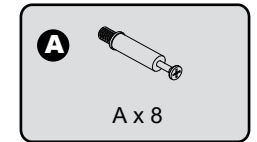



# 7

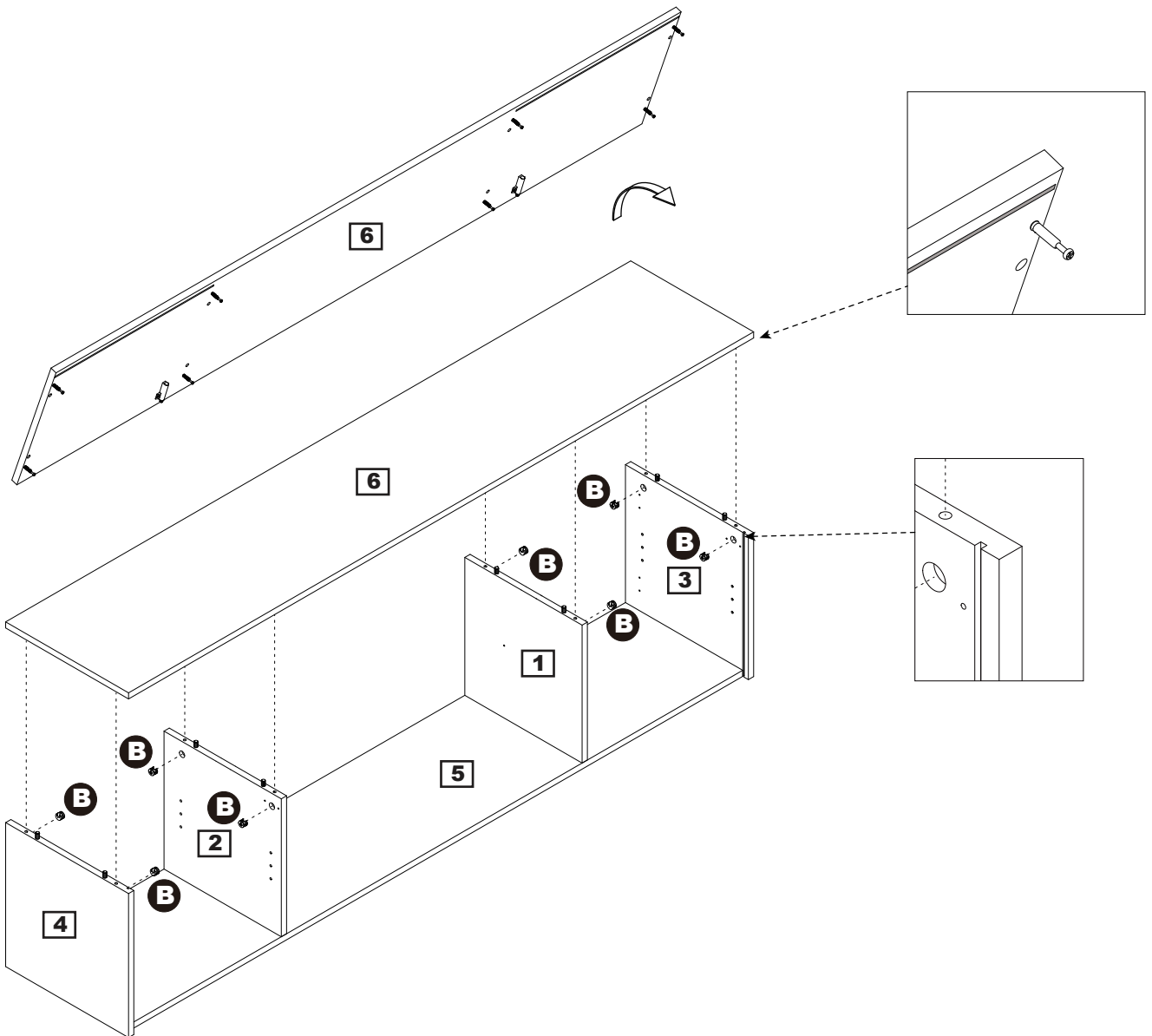
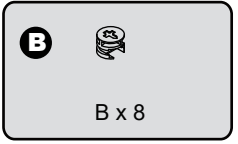
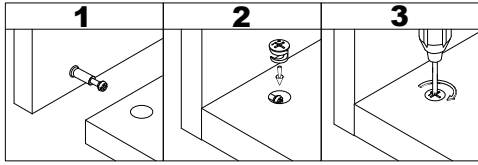

# 8

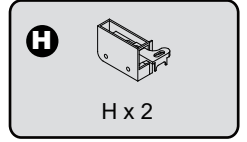
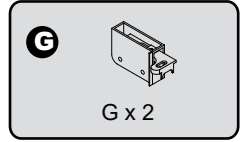
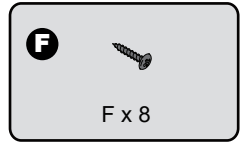
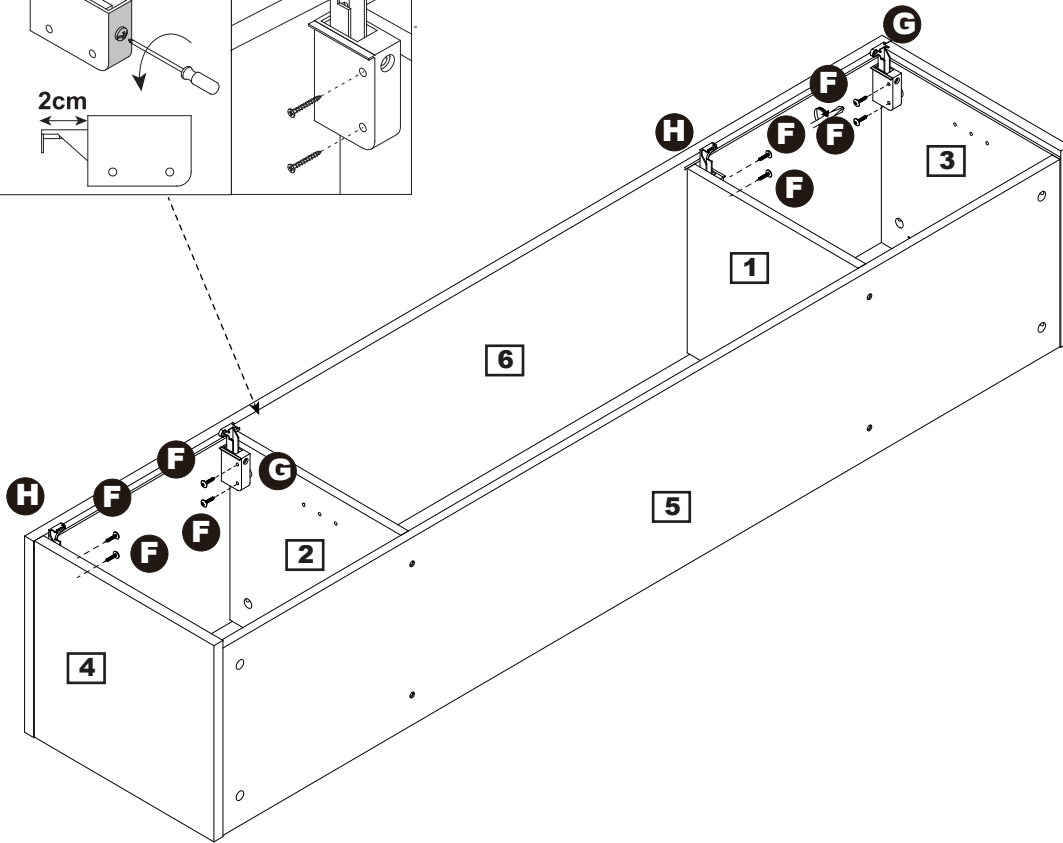
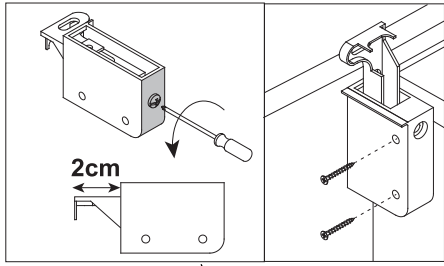

# 9

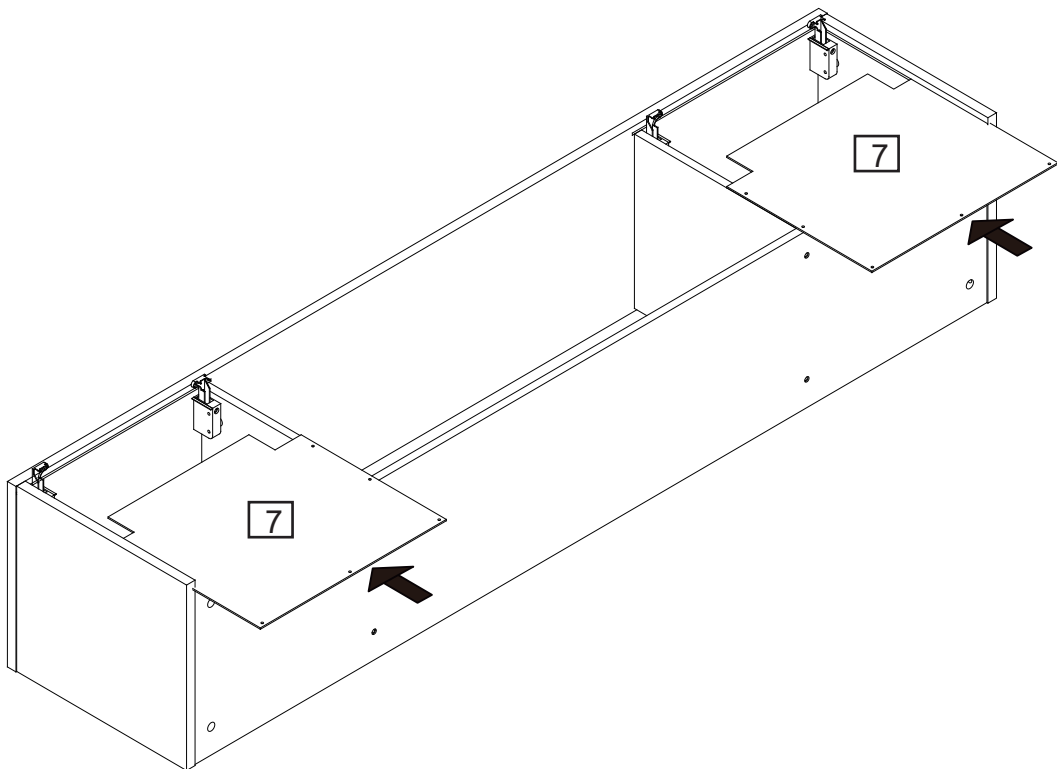

# 10

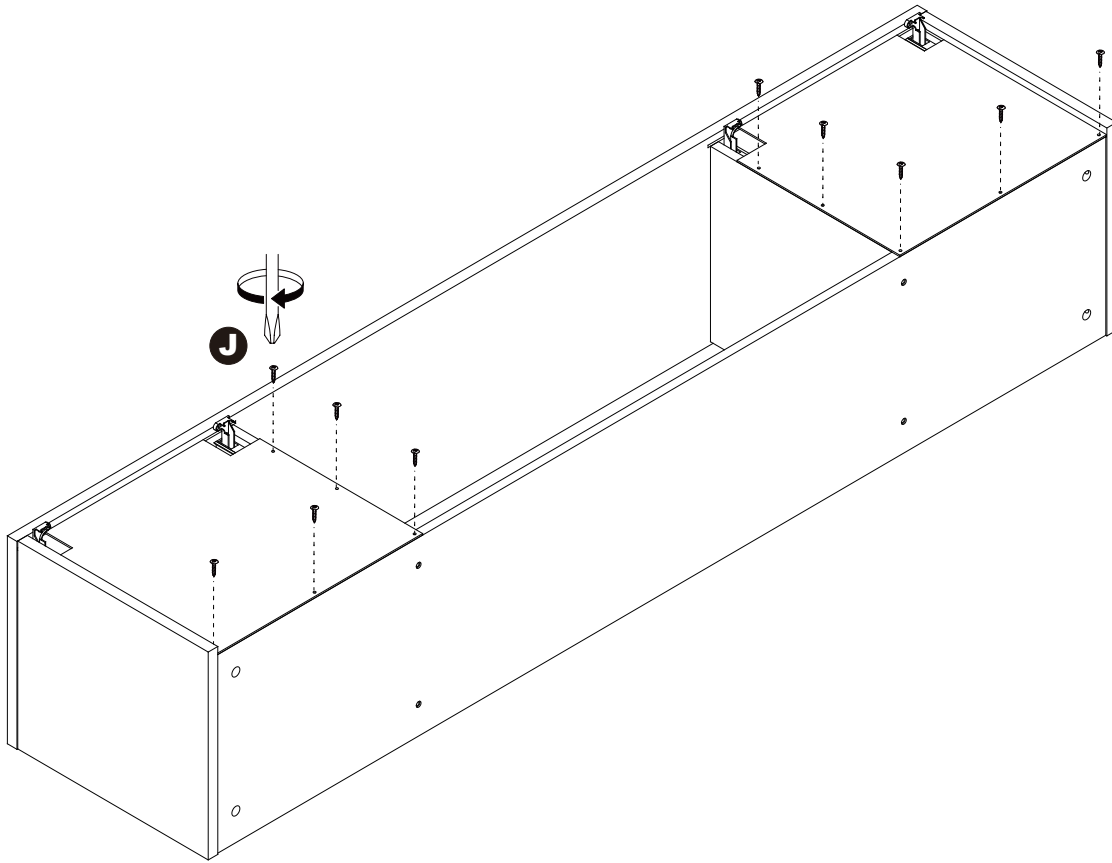
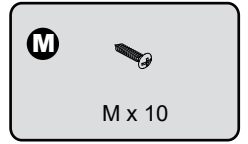

# 11

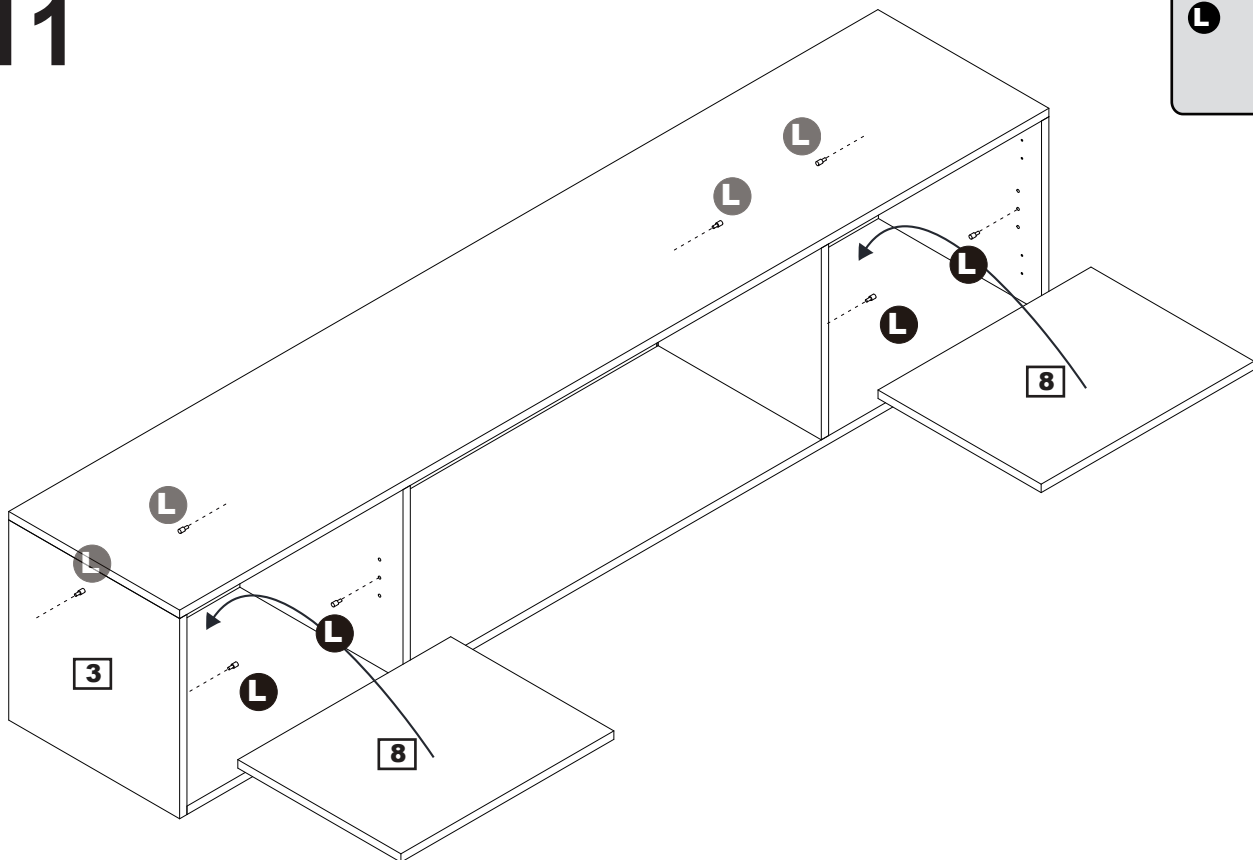
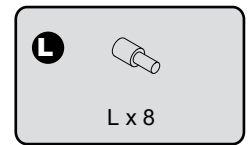

# 12

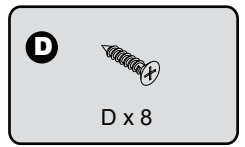
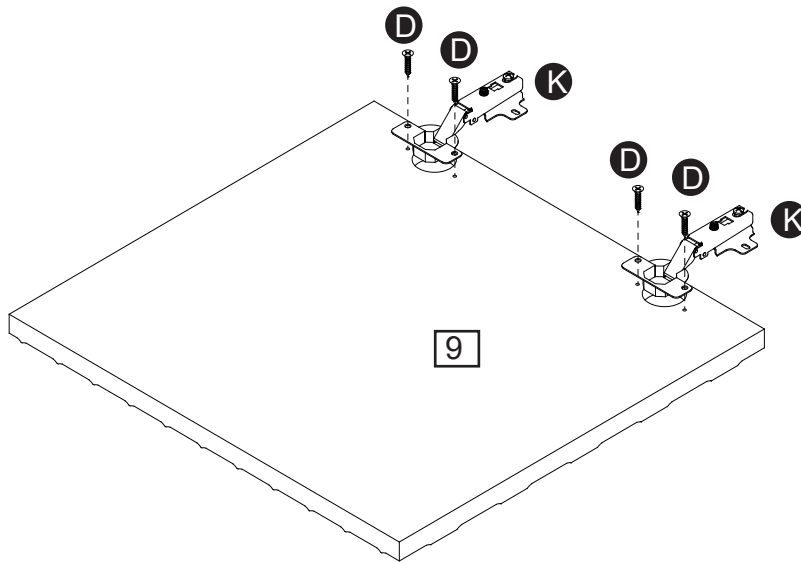

D x 8

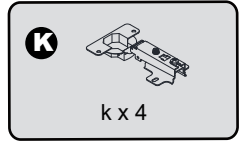

k x 4

## x2

# 13

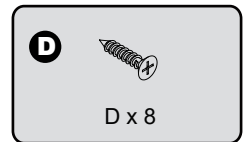
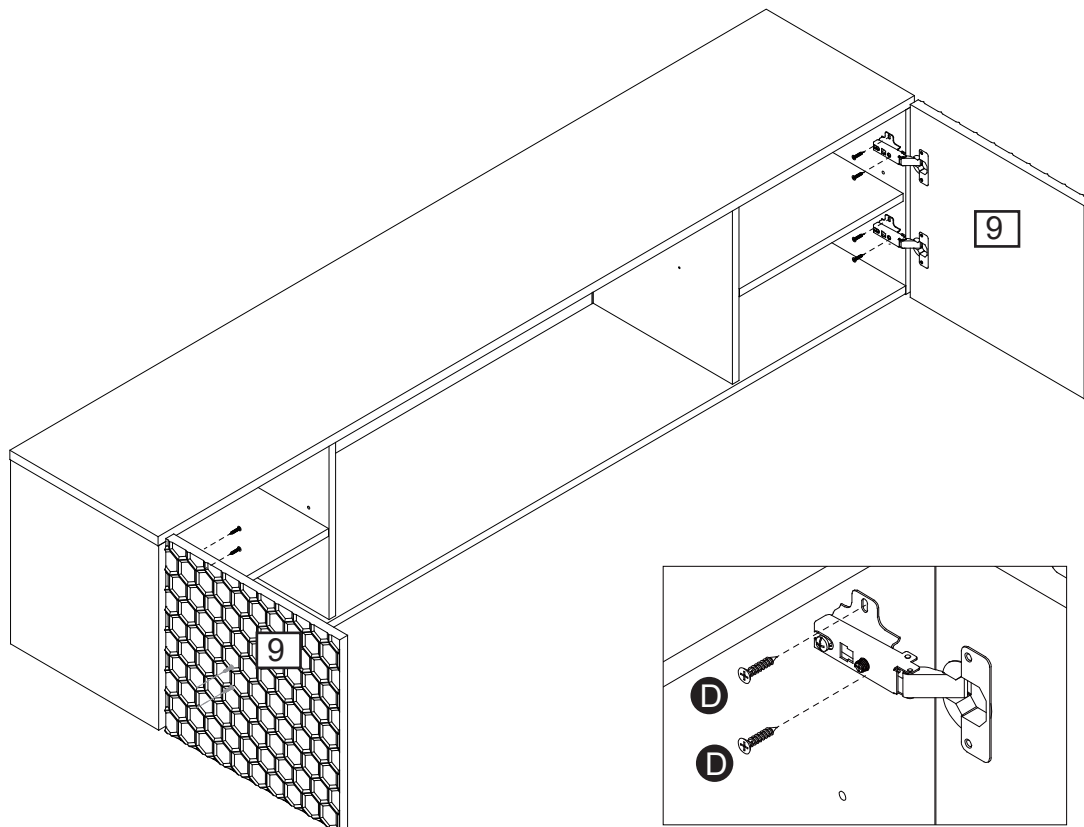

D x 8

DOOR FITTING

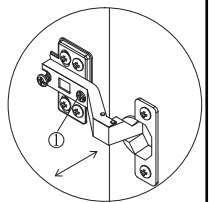

To adjust in width

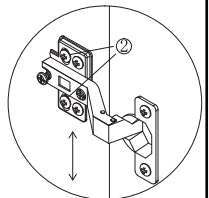

To adjust in height

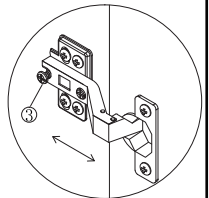

To adjust in depth

# 14

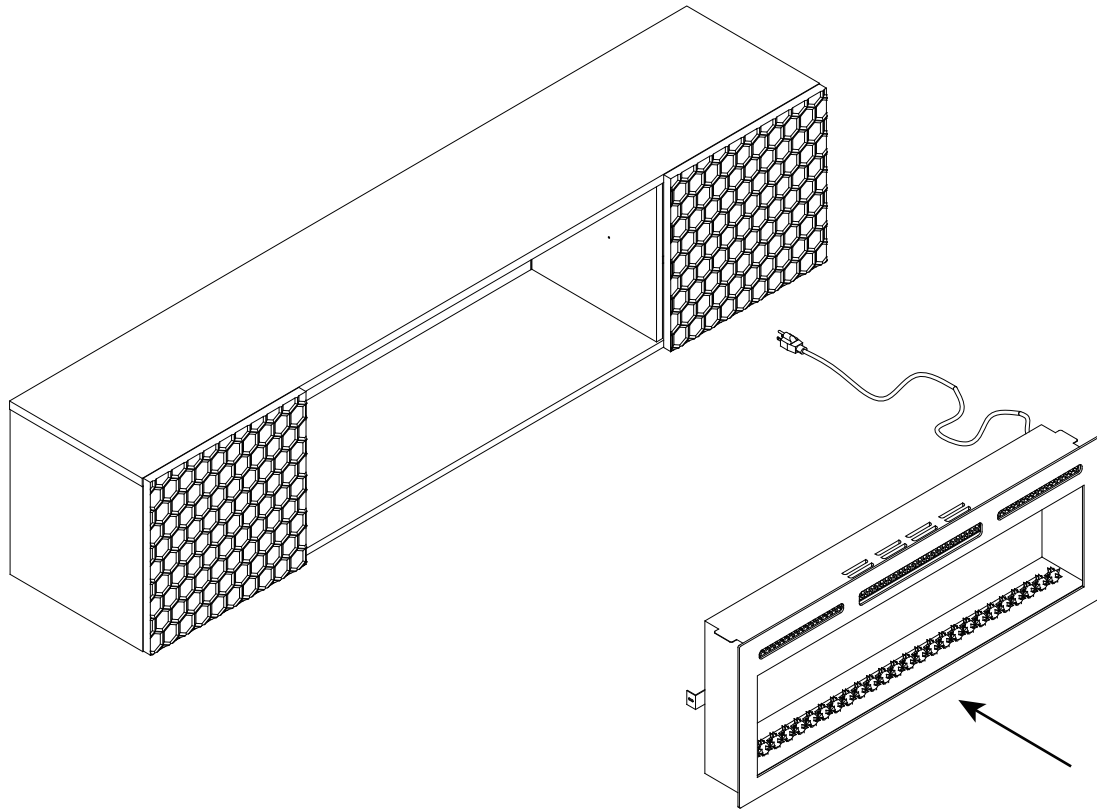

**Assemble the fireplace insert to the stand.**

# 15

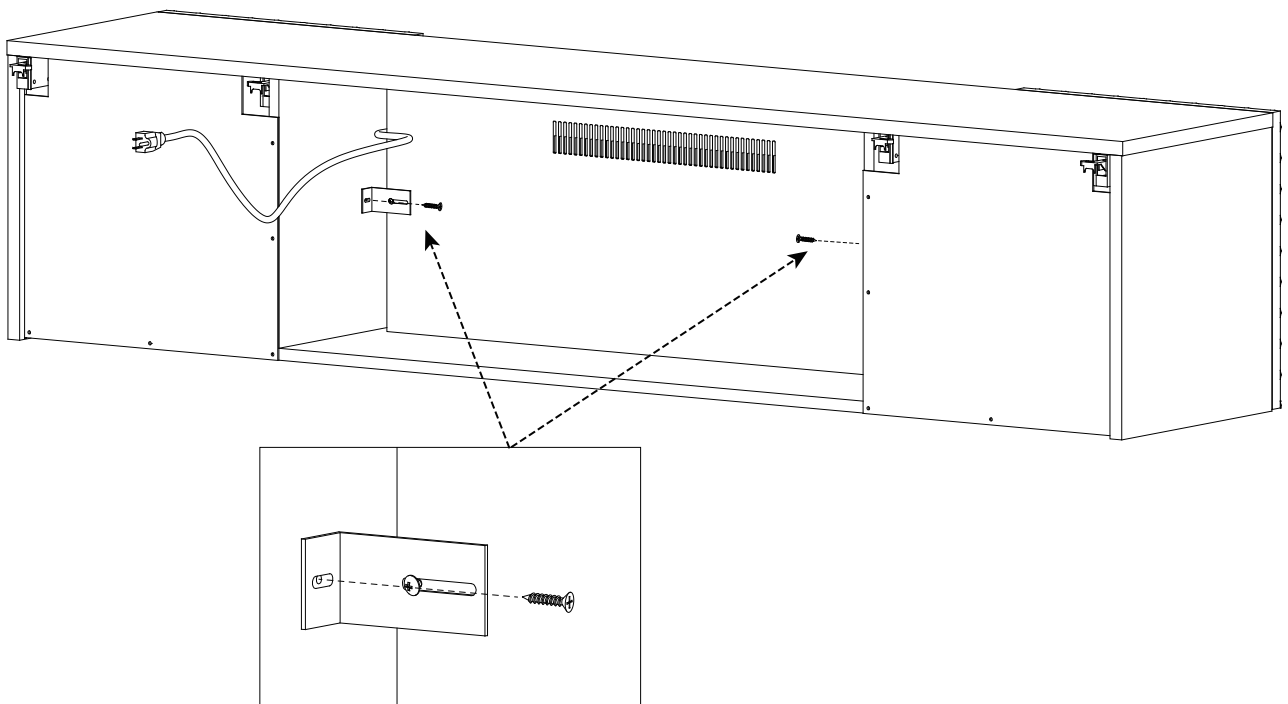
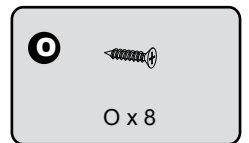

**Use 2pcs of 4x10mm screws to secure fix bracket to fireplace,  
and then use screw (O) to secure fix bracket to part (1,2) with a screwdriver.**

# 16

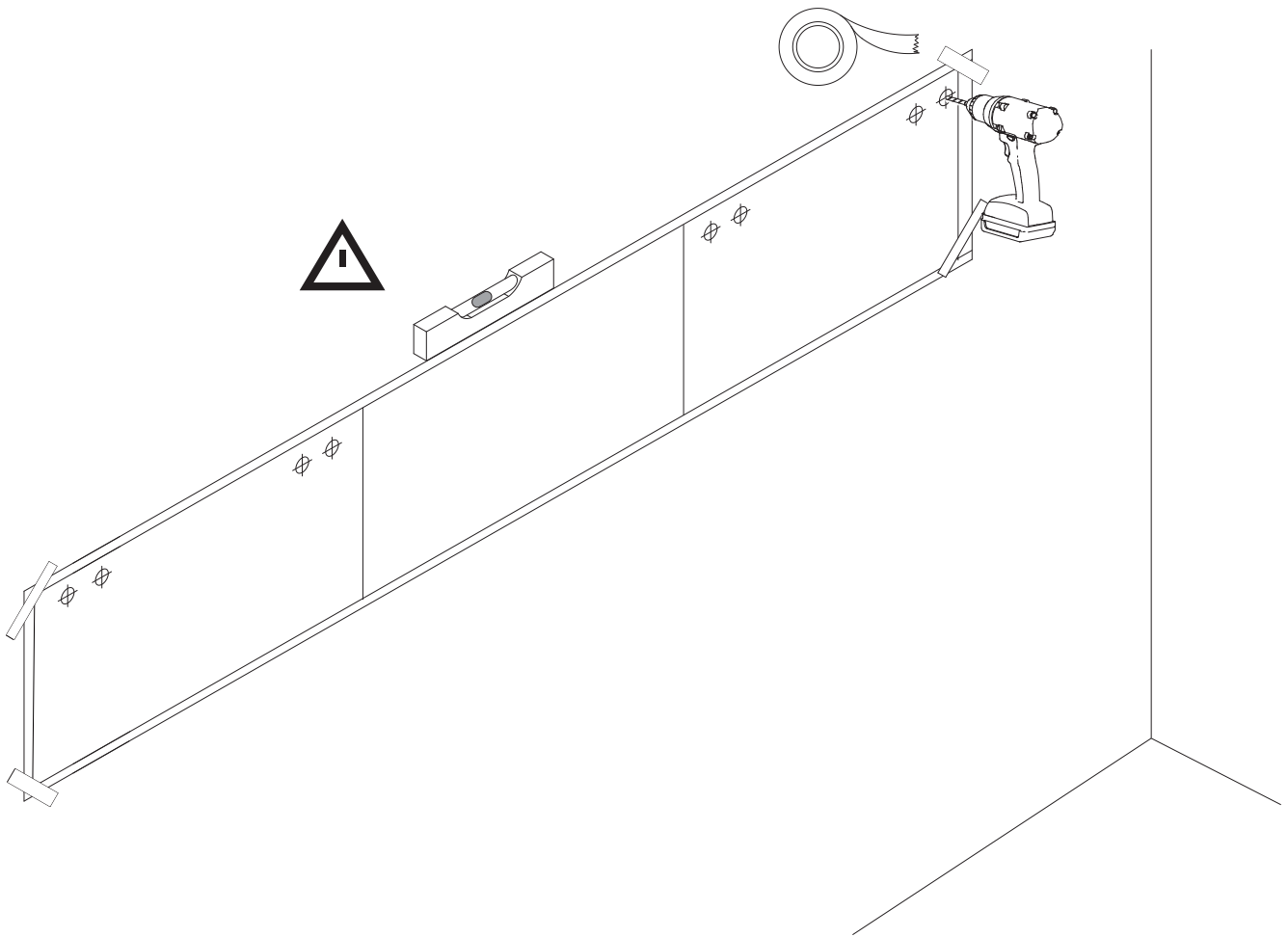

**Tape the cardboard to the wall where the TV stand will be mounted**

**Drill the hole on the target mark on the cardboard.**

**Note1: Use a level to make sure the cardboard is level.**

**Note2: Always ensure the wall to be drilled is free from hidden electrical wires, water and gas pipes.**

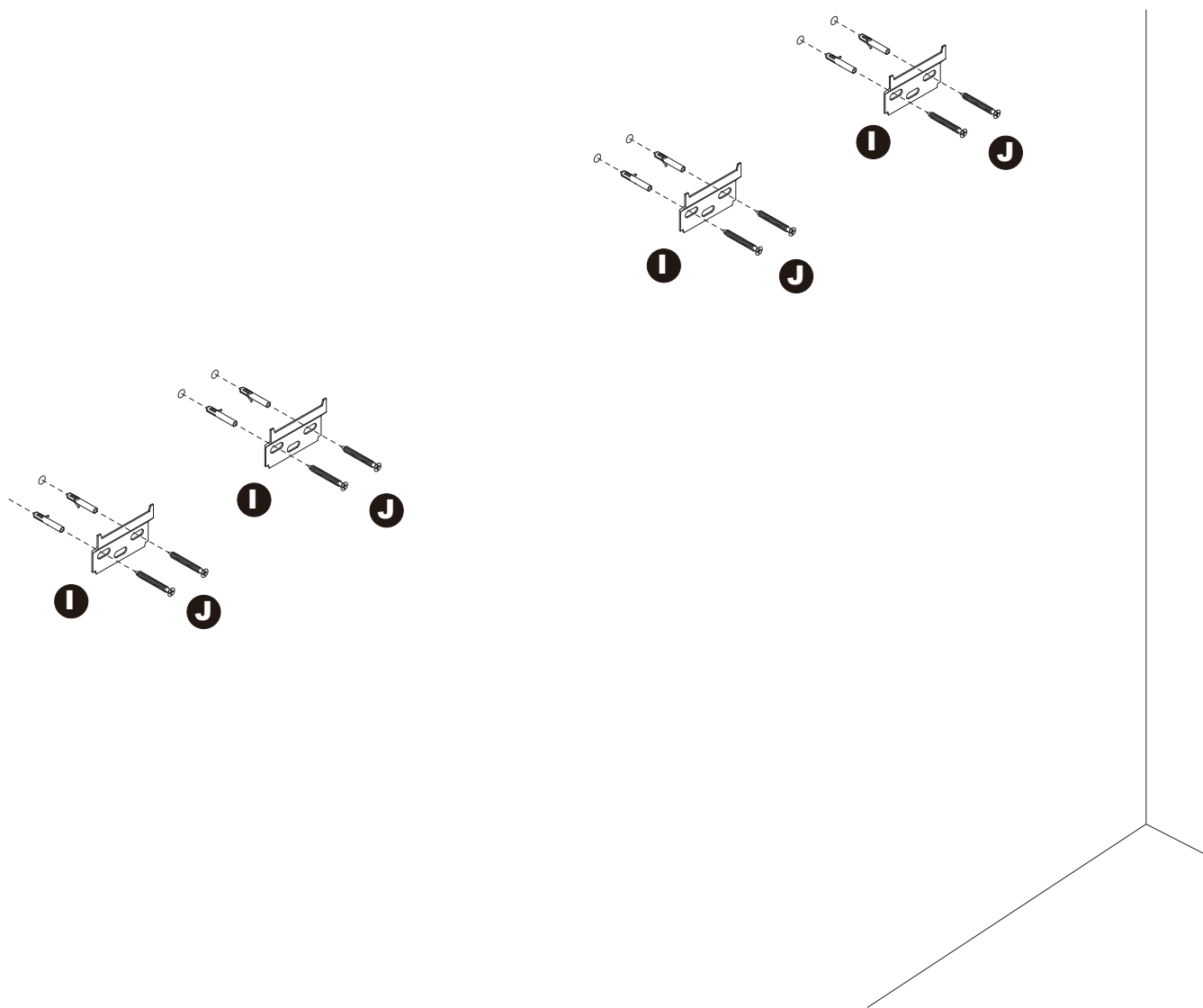
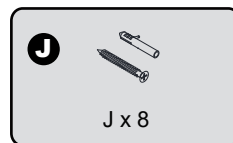
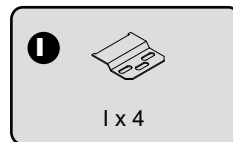

Insert appropriate wall plugs into each hole, then install cleat (I) to the wall using screw (J).

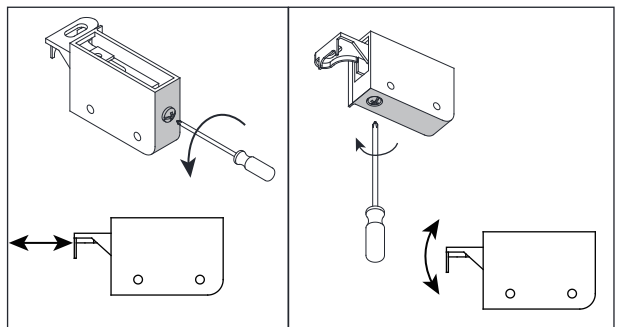
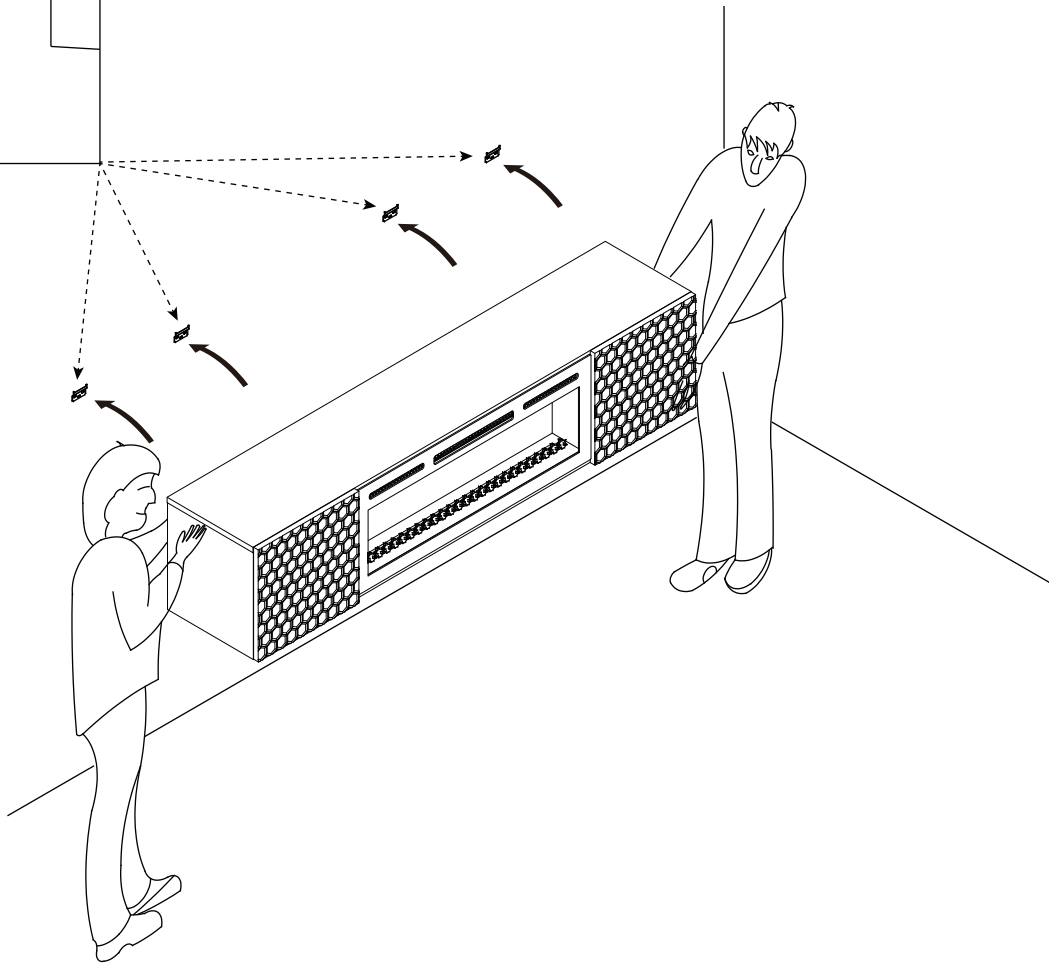
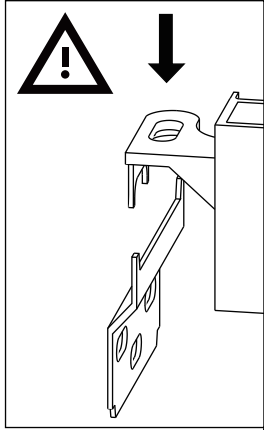

**Make sure all 4 brackets and cleats are securely interlocked.**



# A Guide to Wall Mounting & Fixings

## Important note:

If plastic wall plugs (rawl plugs) are supplied with your product, e.g.:



- these are only suitable for use in masonry walls.

If you are in any doubt about the correct wall plugs for your wall, seek professional advice.

Failure of the product due to using the incorrect fixings is the responsibility of the installer.



**Important:** when drilling into walls always check that there are no hidden wires or pipes etc.

Make sure that the screws and wall plugs being used are suitable for **supporting your unit**. **Consult a qualified tradesperson if you are unsure.**

Hints:

- 1: General rule:  always use a larger screw and wall plug if you are not sure.
- 2: Ensure you use the recommended drill bit to match the wall plug and hole size.
- 3: Ensure you drill the hole horizontally; do not force the drill or enlarge the hole.
- 4: Take extra care when drilling high walls, ceilings and ceramic tiles. Ensure wall plugs are inserted beyond the thickness of the ceramic tiles to avoid the tiles splitting or cracking.
- 5: Ensure wall plugs are well fitted and are a tight fit in the drilled hole.

## Types of walls

You can use one of the following types of wall plug if your walls are made of brick, breeze block, concrete, stone or wood.

No.1 "General Purpose" wall plug

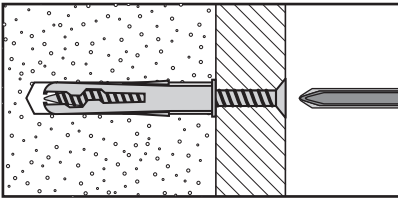

Generally aerated blocks should not be used to support heavy loads, use a specialist fitting in this case. For light loads, general purpose wall plugs can be used.

No.3 "Cavity Fixing" wall plug

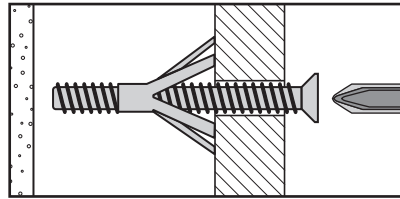

For use with plasterboard partitions or hollow wooden doors.

No.5 "Hammer Fixing" wall plug

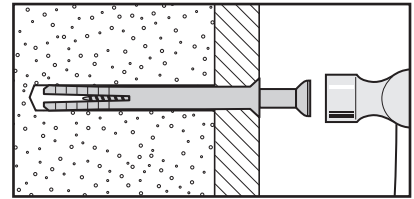

For use with walls stuck with plasterboard. The hammer fixing allows it to be fixed to the wall rather than the plasterboard. Always check the fixing is secure to the retaining wall.

No.2 "Plasterboard" wall plug

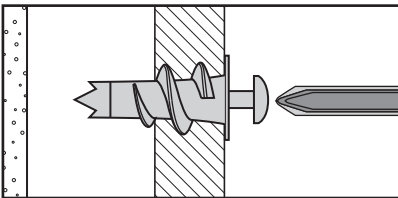

For use when attaching light loads onto plasterboard partitions.

No.4 "Cavity Fixing - Heavy Duty" wall plug

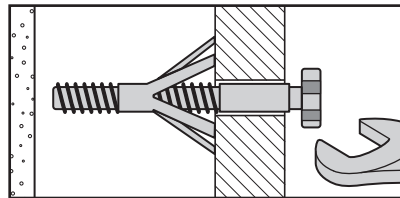

For use when fitting or supporting heavy loads such as shelving, wall cabinets and coat racks.

No.6 "Shield Anchor" wall plug - heavy loads

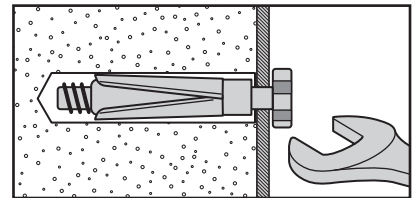

For use with heavier loads such as TV and HiFi speakers and satellite dishes etc.



## Care & Maintenance

**Safety:** always check the fitting and location to ensure your safety in and around the home.

**Fitting:** from time to time check the fitting to ensure the wall plugs or screws do not become loose.