

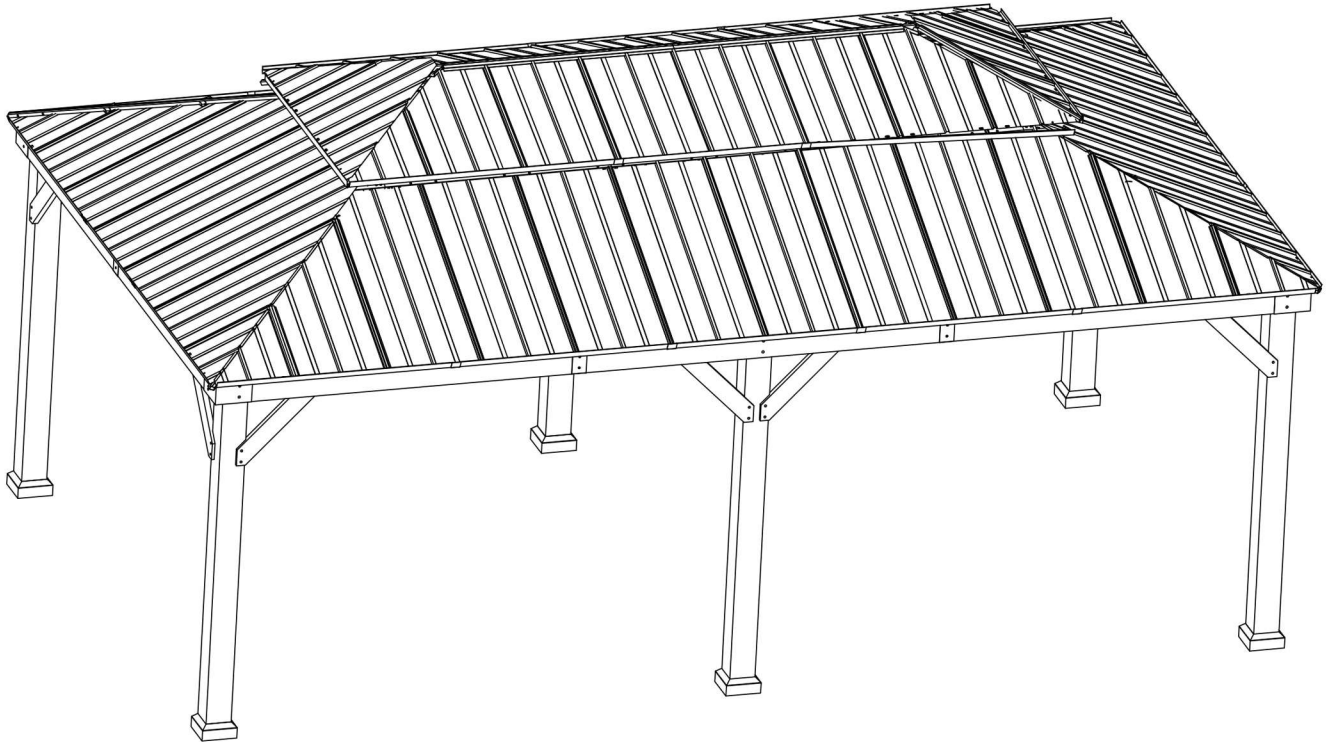

MONDAWE
PICK YOUR FAVORITE

Website: www.mondawe.com
Customer Service: service@mondawe.com
Phone: 888-328-5111

Site Internet : www.mondawe.com
Email de Service Client : service@mondawe.com
Numéro de Téléphone : 888-328-5111



8MO1220140

Assembly Instruction

Instruction de montage

12x20ft Cedar Framed Galvanized Steel Double Roof Gazebo

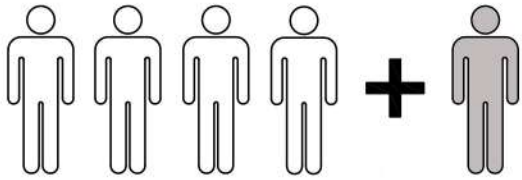

EN: Four or more people are required for assembly

FR: Quatre personnes ou plus sont nécessaires pour l'assemblage

EN: The following tools are not included and needed for assembly

FR: Les outils suivants ne sont pas inclus et nécessaires pour l'assemblage

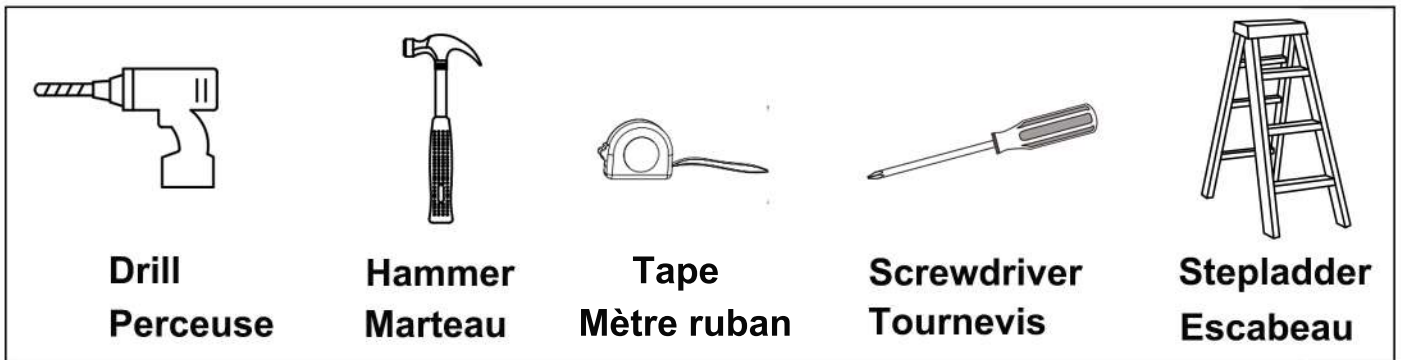

EN: Note:

1. The gazebo come with 8 carton boxes.
2. Wearing protective gloves is recommended.
3. Do not fully tighten screws prior to complete assembly.







FR: Avis:

1. Le gazebo est livré avec 8 boîtes en carton.
2. Le port de gants de protection est recommandé.
3. Ne serrez pas complètement les vis avant de terminer l'assemblage.

EN









Before You Start

-  Please read all instructions carefully.
-  Retain instructions for future reference.
-  Separate and count all parts and hardware.
-  Read through each step carefully and follow the proper order.
-  We recommend that, where possible, all items are assembled near to the area in which they will be placed in use, to avoid moving the product unnecessarily once assembled.
-  Always place the product on a flat, steady and stable surface.
-  Keep all small parts and packaging materials for this product away from babies and children as they potentially pose a serious choking hazard.

FR



Avant de Commencer

-  Veuillez lire attentivement toutes les instructions.
-  Conservez les instructions pour vous y référer ultérieurement.
-  Vérifiez toutes les pièces et les accessoires.
-  Lisez attentivement chaque étape et suivez l'ordre correct.
-  Nous recommandons que, dans la mesure du possible, tous les produits soient assemblés à proximité de la zone où ils seront utilisés, afin d'éviter tout déplacement inutile du produit une fois assemblé.
-  Placez toujours le produit sur une surface plane et stable.
-  Conservez toutes les petites pièces de ce produit et les matériaux d'emballage hors de portée des bébés et des enfants, car ils pourraient présenter un risque d'étouffement.

PARTS LIST (Carton Box -1)

12

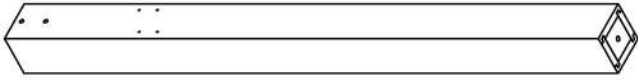

Middle post

2PCS

02

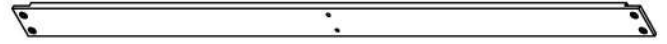

Long side outer middle beam

2PCS

PARTS LIST (Carton Box -2)

11



Corner post

2PCS

01



Long side outer beam

2PCS

PARTS LIST (Carton Box -3)

11

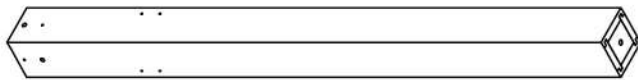

Corner post

2PCS

01



Long side outer beam

2PCS

Liste des pièces(Boîte en carton 1)

12

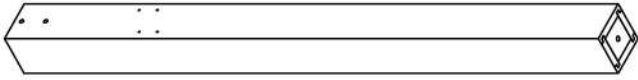

Poteau du milieu

2

02

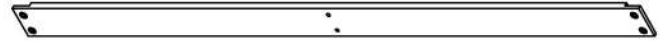

Poutre médian extérieur de côté long

2

Liste des pièces(Boîte en carton 2)

11



Poteau d'angle

2

01



Poutre extérieure de côté long

2

Liste des pièces(Boîte en carton 3)

11

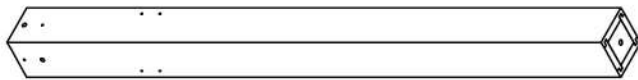

Poteau d'angle

2

01

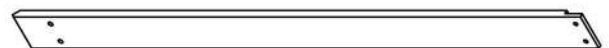

Poutre extérieure de côté long

2

PARTS LIST (Carton Box -4)

03

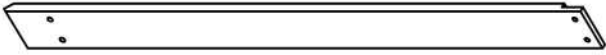

Short side outer left beam

2PCS

04

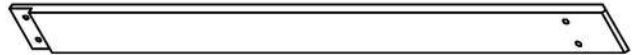

Short side outer right beam

2PCS

05

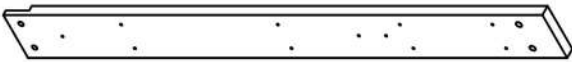

Long side inner beam

4PCS

06

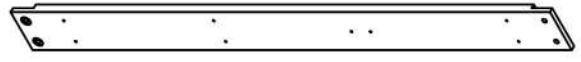

Long side inner middle beam 1

2PCS

07

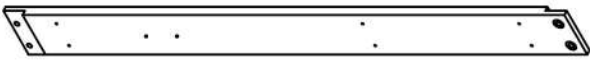

Long side inner middle beam 2

2PCS

08

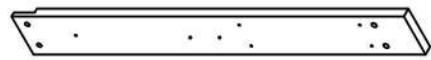

Short side inner beam

4PCS

10

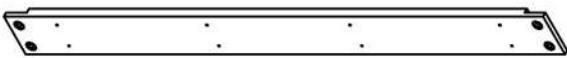

Short side inner middle beam

2PCS

13

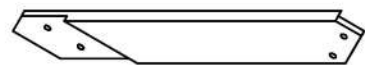

Left suport

6PCS

14

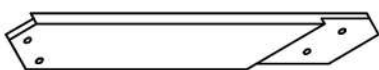

Right suport

6PCS

Liste des pièces(Boîte en carton 4)

03

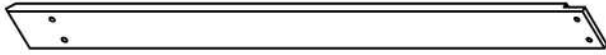

Poutre extérieur gauche du côté court

2

04

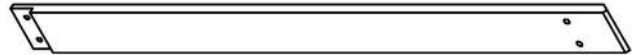

Poutre droit extérieur du côté court

2

05

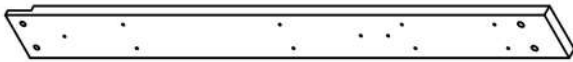

Poutre intérieure de côté long

4

06

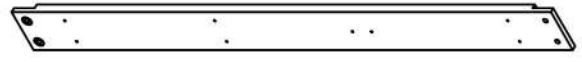

Poutre centrale intérieure de côté long 1

2

07

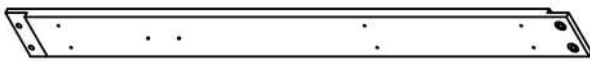

Poutre centrale intérieure de côté long 2

2

08

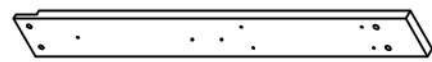

Poutre intérieure de côté court

4

10

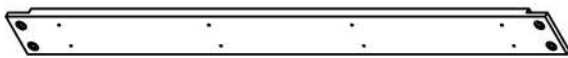

Poutre central intérieur du côté court

2

13

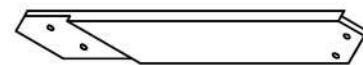

Support de gauche

6

14



Support côté droit

6

PARTS LIST (Carton Box -5)

T3

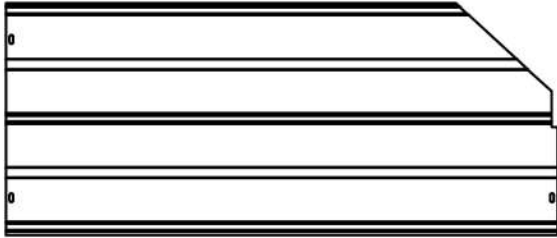

Big roof left cover plate

4PCS

T4

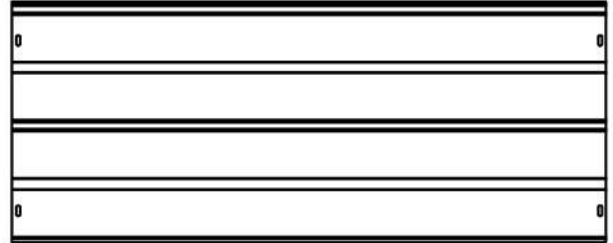

Big roof middle cover plate

14PCS

T5

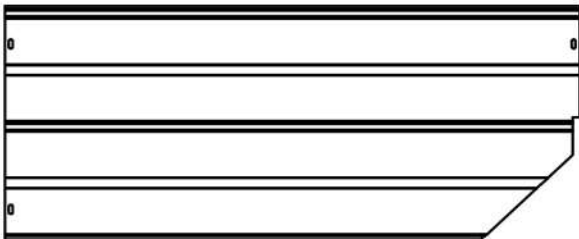

Big roof right cover plate

4PCS

Liste des pièces(Boîte en carton 5)

T3

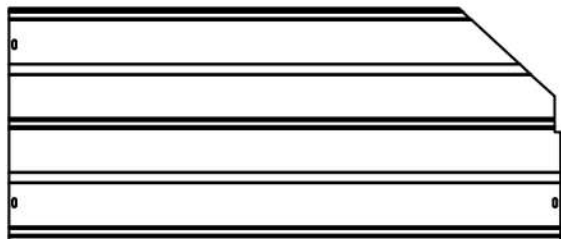

Grande plaque de couverture gauche de grand toit

4

T4

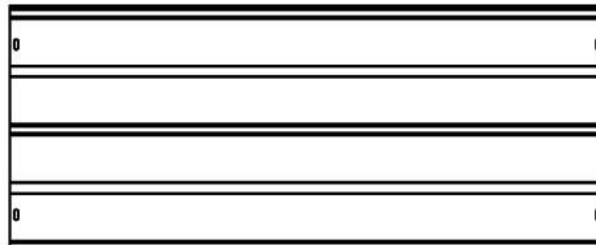

Plaque de couverture moyenne de grand toit

14

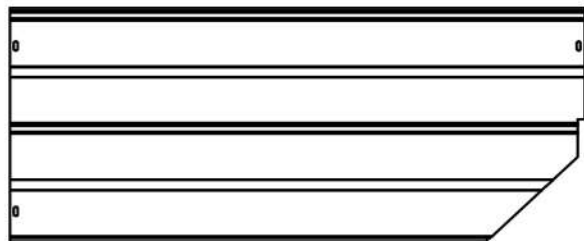

T5



Grande plaque de couverture droite de grand toit

4

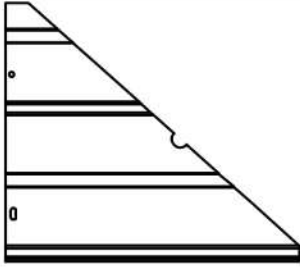
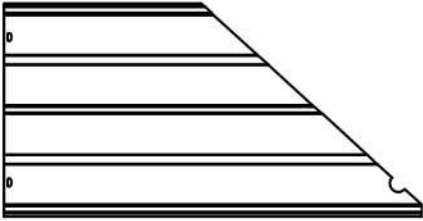
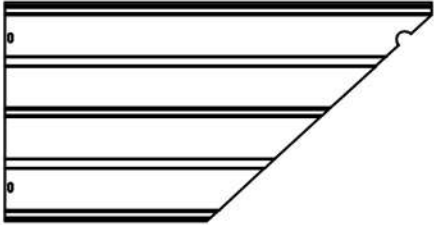
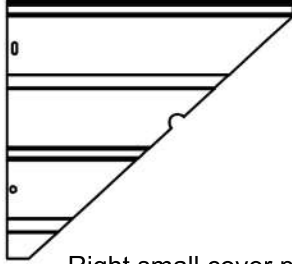
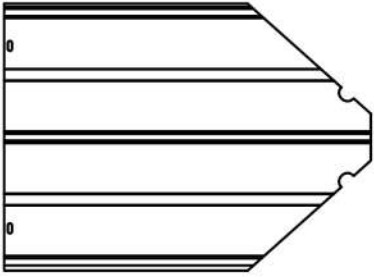
PARTS LIST (Carton Box -6)

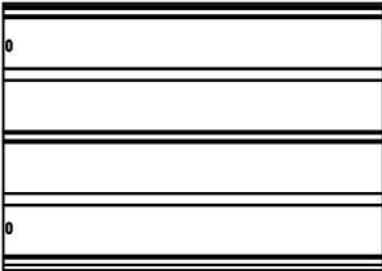
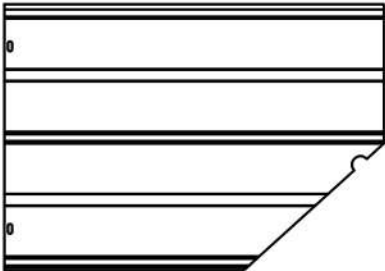
| | |
|---|---|
| <div style="border: 1px solid black; padding: 5px; width: fit-content;">T1</div>  <p style="text-align: center;">Left small cover plate</p> <p style="text-align: center; font-weight: bold;">8PCS</p> | <div style="border: 1px solid black; padding: 5px; width: fit-content;">T2</div>  <p style="text-align: center;">Big roof left cover plate</p> <p style="text-align: center; font-weight: bold;">4PCS</p> |
| <div style="border: 1px solid black; padding: 5px; width: fit-content;">T6</div>  <p style="text-align: center;">Big roof right cover plate</p> <p style="text-align: center; font-weight: bold;">4PCS</p> | <div style="border: 1px solid black; padding: 5px; width: fit-content;">T7</div>  <p style="text-align: center;">Right small cover plate</p> <p style="text-align: center; font-weight: bold;">8PCS</p> |
| <div style="border: 1px solid black; padding: 5px; width: fit-content;">T8</div>  <p style="text-align: center;">Small roof middle cover plate</p> <p style="text-align: center; font-weight: bold;">2PCS</p> | <div style="border: 1px solid black; padding: 5px; width: fit-content;">T9</div>  <p style="text-align: center;">Small roof left cover plate</p> <p style="text-align: center; font-weight: bold;">2PCS</p> |
| <div style="border: 1px solid black; padding: 5px; width: fit-content;">T10</div>  <p style="text-align: center;">Small roof middle cover plate</p> <p style="text-align: center; font-weight: bold;">8PCS</p> | <div style="border: 1px solid black; padding: 5px; width: fit-content;">T11</div>  <p style="text-align: center;">Small roof right cover plate</p> <p style="text-align: center; font-weight: bold;">2PCS</p> |

Liste des pièces(Boîte en carton 6)

T1

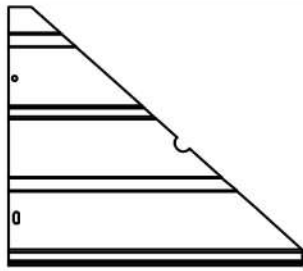

Petite plaque de couverture gauche

8

T2

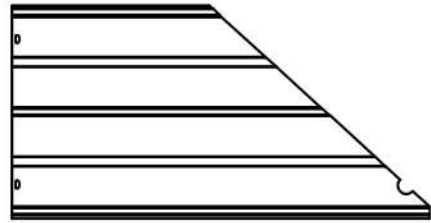

Plaque de couverture gauche du grand toit

4

T6

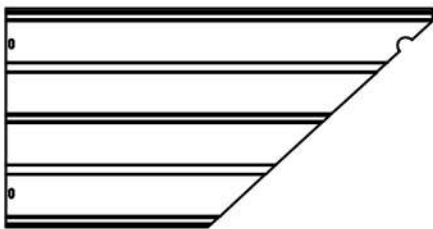

Plaque de couverture droite de grand toit

4

T7

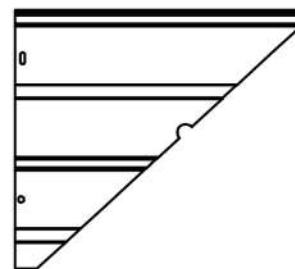

Petite plaque de couverture droite

8

T8

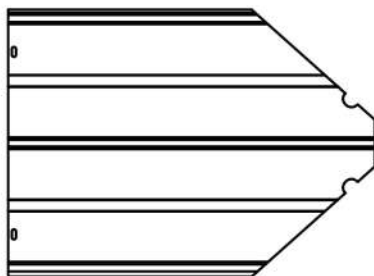

Plaque de couverture centrale de petit toit

2

T9



Plaque de couverture gauche de petit toit

2

T10

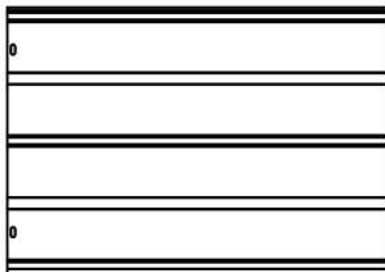

Plaque de couverture centrale de petit toit

8













T11







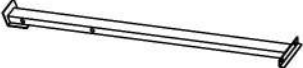









Plaque de couverture droite de petit toit

2















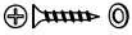

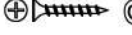



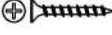



PARTS LIST (Carton Box -7)

| | |
|---|---|
| <p>S1</p>  <p>Small roof cover</p> <p>2PCS</p> | <p>I2</p>  <p>Big roof long side right tube</p> <p>2PCS</p> |
| <p>G1</p>  <p>Big roof long slant beam</p> <p>4PCS</p> | <p>P1</p>  <p>Big roof inner bracket</p> <p>2PCS</p> |
| <p>F9</p>  <p>Conner cover</p> <p>4PCS</p> | <p>M1</p>  <p>Small roof inner bracket</p> <p>1PCS</p> |
| <p>S2</p>  <p>Big roof long slant beam cover</p> <p>4PCS</p> | <p>H1</p>  <p>Big roof top beam</p> <p>12PCS</p> |
| <p>09</p>  <p>Base cover</p> <p>6PCS</p> | <p>B6</p>  <p>Base</p> <p>6PCS</p> |
| <p>G5</p>  <p>Slant beam bottom connector</p> <p>4PCS</p> | <p>H3</p>  <p>Small roof top beam</p> <p>4PCS</p> |
| <p>I1</p>  <p>Big roof long side left tube</p> <p>2PCS</p> | <p>L1</p>  <p>Small roof slant beam</p> <p>4PCS</p> |



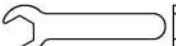











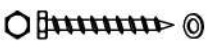
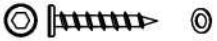
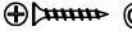









Liste des pièces(Boîte en carton 7)

| | |
|---|---|
| <p>S1</p>  <p>Petite couverture de toit</p> | <p>I2</p>  <p>Tube droit de long côté de grand toit</p> |
| <p>2</p> | <p>2</p> |
| <p>G1</p>  <p>Longue poutre inclinée de grand toit</p> | <p>P1</p>  <p>Support intérieur d'un grand toit</p> |
| <p>4</p> | <p>2</p> |
| <p>F9</p>  <p>Couvercle d'angle</p> | <p>M1</p>  <p>Support intérieur d'un petit toit</p> |
| <p>4</p> | <p>1</p> |
| <p>S2</p>  <p>Longue couverture de poutre inclinée d'un grand toit</p> | <p>H1</p>  <p>Poutre supérieure de grand toit</p> |
| <p>4</p> | <p>12</p> |
| <p>09</p>  <p>Couvercle de base</p> | <p>B6</p>  <p>Base</p> |
| <p>6</p> | <p>6</p> |
| <p>G5</p>  <p>Connecteur inférieur de poutre inclinée</p> | <p>H3</p>  <p>Poutre supérieure de petit toit</p> |
| <p>4</p> | <p>4</p> |
| <p>I1</p>  <p>Tube gauche de long côté de grand toit</p> | <p>L1</p>  <p>Poutre inclinée de petit toit</p> |
| <p>2</p> | <p>4</p> |























HARDWARE LIST (Carton Box -7)

| | | |
|---|---|---|
| N1  Hook 2PCS | R1  Press panel 70PCS | F5  Small post plate 2PCS |
| AA  M10x215 Outer Hex head bolt & Washer 12PCS | BB  M5x25 Self-tapping screw & Washer 72+7PCS | CC  M10x100 Self-tapping screw & Washer 8PCS |
| DD  M8x40 Self-tapping screw & Washer 48+4PCS | EE  M5x40 Self-tapping screw & Washer 36+3PCS | FF  M8x30 Inner Hex head screw & Washer 28+2PCS |
| GG  M6 Nut & Washer 20+2PCS | HH  M6x15 Inner Hex head screw & Washer 120+12PCS | II  M6x15 Outer Hex head bolt & Washer 16+2PCS |
| JJ  M5x50 Self-tapping screw 96+9PCS | KK  M6x55 Inner Hex head screw & Nut 16+2PCS | LL  M6x75 Inner Hex head screw & Nut 4+1PCS |
| MM  M10 Nut 12+1PCS | NN  M6x45 Inner Hex head screw & Nut 4+1PCS | PP  M8 Nut 28+3PCS |
| TT  M6x15 Inner Hex head screw & Washer 172+17PCS | UU  Φ6x200 Stake 24PCS | VV  M3 Drill 2PCS |
| Z1  M6 Wrench 2PCS | Z2  M6 Screwdriver set head 1PCS | Z3  M10 Wrench 2PCS |
| Z4  M8 Allen key 2PCS | Z5  M6 Allen key 2PCS | Z6  M6 Allen key 1PCS |























Liste des quincaillerie(Boîte en carton 7)

| | | |
|--|---|--|
| N1  Crochet | R1  Panneau de presse | F5  Petite plaque de poteau |
| 2 | 70 | 2 |
| AA  M10x215 Boulon de tête hexagonal extérieur & Rondelle | BB  M5x25 Vis taraudeuse & Rondelle | CC  M10x100 Vis taraudeuse & Rondelle |
| 12 | 72+7 | 8 |
| DD  M8x40 Vis taraudeuse & Rondelle | EE  M5x40 Vis taraudeuse & Rondelle | FF  M8x30 Vis à tête hexagonale interne & Rondelle |
| 48+4 | 36+3 | 28+2 |
| GG  M6 Écrou & Rondelle | HH  M6x15 Vis à tête hexagonale interne & Rondelle | II  M6x15 Boulon de tête hexagonal extérieur & Rondelle |
| 20+2 | 120+12 | 16+2 |
| JJ  M5x50 Vis taraudeuse | KK  M6x55 Vis à tête hexagonale interne & Écrou | LL  M6x75 Vis à tête hexagonale interne & Écrou |
| 96+9 | 16+2 | 4+1 |
| MM  M10 Écrou | NN  M6x45 Vis à tête hexagonale interne & Écrou | PP  M8 Écrou |
| 12+1 | 4+1 | 28+3 |
| TT  M6x15 Inner Hex head screw & Washer | UU  Φ6x200 Piquet | VV  M3 Foret |
| 172+17 | 24 | 2 |
| Z1  M6 Clef de tête hexagonal extérieur | Z2  M6 Tête de jeu de tournevis | Z3  M10 Clef de tête hexagonal extérieur |
| 2 | 1 | 2 |
| Z4  M8 Clef de tête hexagonal intérieur | Z5  M6 Clef de tête hexagonal intérieur | Z6  M6 Clef de tête hexagonal intérieur |
| 2 | 2 | 1 |

PARTS LIST (Carton Box -8)

| | |
|---|---|
| <p>E1</p>  <p style="text-align: center;">Short side curtain bar</p> <p style="text-align: center;">4PCS</p> | <p>I3</p>  <p style="text-align: center;">Big roof short side tube</p> <p style="text-align: center;">2PCS</p> |
| <p>K10</p>  <p style="text-align: center;">Long side middle blocking bar</p> <p style="text-align: center;">4PCS</p> | <p>Q2</p>  <p style="text-align: center;">Small roof short side blocking bar</p> <p style="text-align: center;">2PCS</p> |
| <p>J1</p>  <p style="text-align: center;">Small roof long connector</p> <p style="text-align: center;">2PCS</p> | <p>F3</p>  <p style="text-align: center;">Small roof long side left blocking bar</p> <p style="text-align: center;">2PCS</p> |
| <p>F4</p>  <p style="text-align: center;">Small roof long side right blocking bar</p> <p style="text-align: center;">2PCS</p> | <p>J2</p>  <p style="text-align: center;">Small roof side connector</p> <p style="text-align: center;">2PCS</p> |
| <p>F8</p>  <p style="text-align: center;">Middle cover</p> <p style="text-align: center;">6PCS</p> | <p>E3</p>  <p style="text-align: center;">Long side curtain bar</p> <p style="text-align: center;">8PCS</p> |
| <p>K5</p>  <p style="text-align: center;">Long side middle across bar</p> <p style="text-align: center;">4PCS</p> | <p>K2</p>  <p style="text-align: center;">Short side middle across bar</p> <p style="text-align: center;">4PCS</p> |
| <p>K4</p>  <p style="text-align: center;">Big roof lower across bar</p> <p style="text-align: center;">8PCS</p> | <p>K1</p>  <p style="text-align: center;">Long side across bar</p> <p style="text-align: center;">8PCS</p> |
| <p>K3</p>  <p style="text-align: center;">Big roof upper across bar</p> <p style="text-align: center;">8PCS</p> | <p>H2</p>  <p style="text-align: center;">Bottom connector for small roof top beam</p> <p style="text-align: center;">4PCS</p> |
| <p>O1</p>  <p style="text-align: center;">Big roof middle tube</p> <p style="text-align: center;">3PCS</p> | <p>K7</p>  <p style="text-align: center;">Big roof blocking bar 1</p> <p style="text-align: center;">4PCS</p> |
| <p>K8</p>  <p style="text-align: center;">Big roof blocking bar 2</p> <p style="text-align: center;">4PCS</p> | <p>K9</p>  <p style="text-align: center;">Big roof long side blocking bar</p> <p style="text-align: center;">4PCS</p> |
| <p>S3</p>  <p style="text-align: center;">Small roof slant cover 1</p> <p style="text-align: center;">2PCS</p> | <p>S4</p>  <p style="text-align: center;">Small roof slant cover 2</p> <p style="text-align: center;">2PCS</p> |
| <p>K6</p>  <p style="text-align: center;">Short side middle blocking bar</p> <p style="text-align: center;">2PCS</p> | |

Liste des pièces(Boîte en carton 8)

| | | | |
|-----|---|----|---|
| E1 |  Barre à rideau de côté court | I3 |  Tube latéral court de grand toit |
| | 4 | | 2 |
| K10 |  Barre de blocage centrale de côté long | Q2 |  Barre de blocage du côté court du petit toit |
| | 4 | | 2 |
| J1 |  Long connecteur de petit toit | F3 |  Barre de blocage gauche du long côté du petit toit |
| | 2 | | 2 |
| F4 |  Barre de blocage droite du long côté du petit toit | J2 |  Connecteur latéral de petit toit |
| | 2 | | 2 |
| F8 |  Couvercle central | E3 |  Barre à rideau de côté long |
| | 6 | | 8 |
| K5 |  Milieu à travers la barre de côté long | K2 |  Milieu à travers la barre de côté court |
| | 4 | | 4 |
| K4 |  Barre inférieure à travers de grand toit | K1 |  Barre transversale de côté long |
| | 8 | | 8 |
| K3 |  Barre supérieure traversante de grand toit | H2 |  Connecteur inférieur pour poutre supérieure de petit toit |
| | 8 | | 4 |
| O1 |  Haut à travers la poutre du grand toit | K7 |  Barre de blocage de grand toit 1 |
| | 3 | | 4 |
| K8 |  Barre de blocage de grand toit 2 | K9 |  Barre de blocage de long côté de grand toit |
| | 4 | | 4 |
| S3 |  Couverture inclinée d'un petit toit 1 | S4 |  Couverture inclinée d'un petit toit 2 |
| | 2 | | 2 |
| K6 |  Barre de blocage centrale du côté court | | |
| | 2 | | |

Exploded Views Vue éclatées

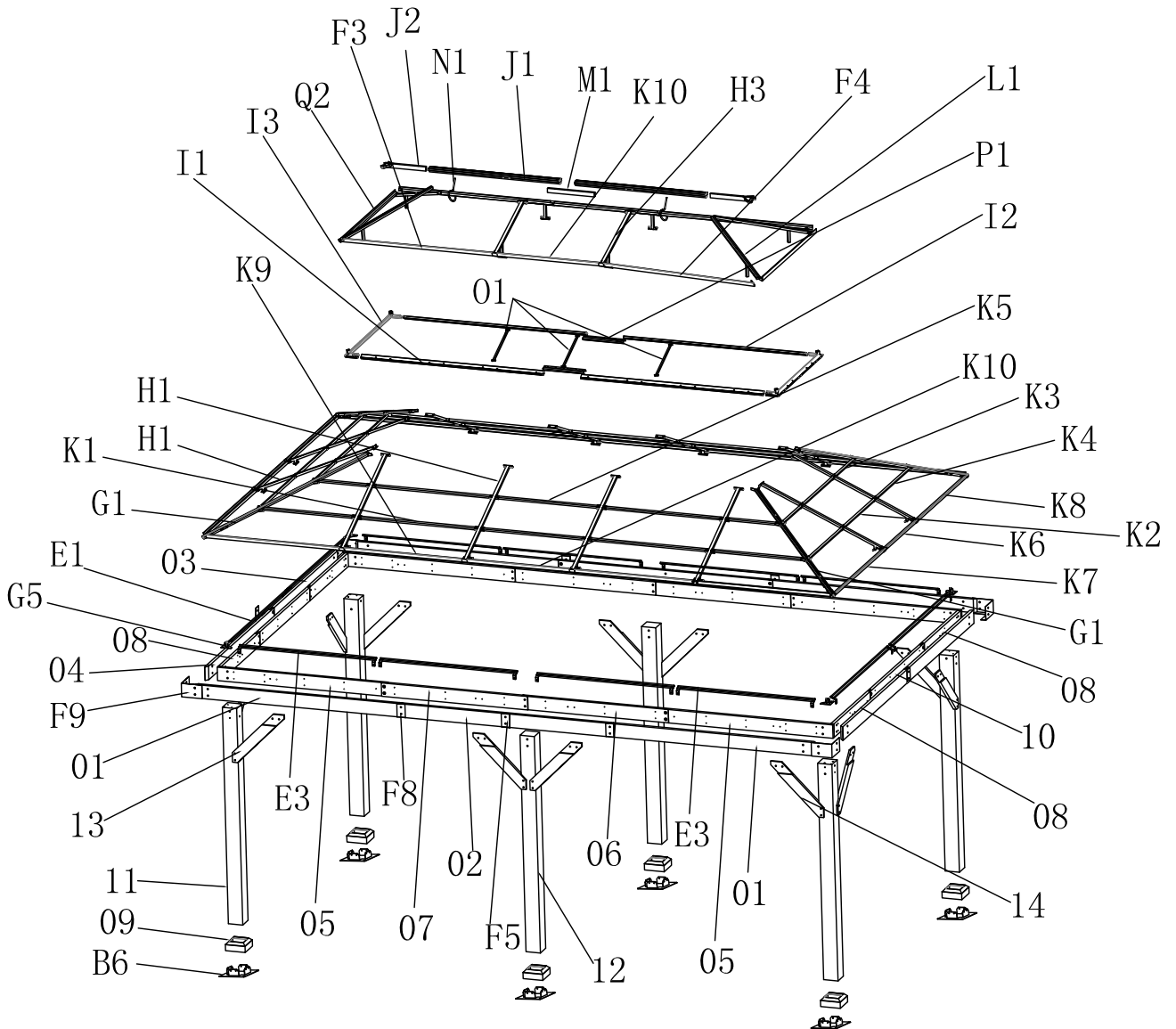
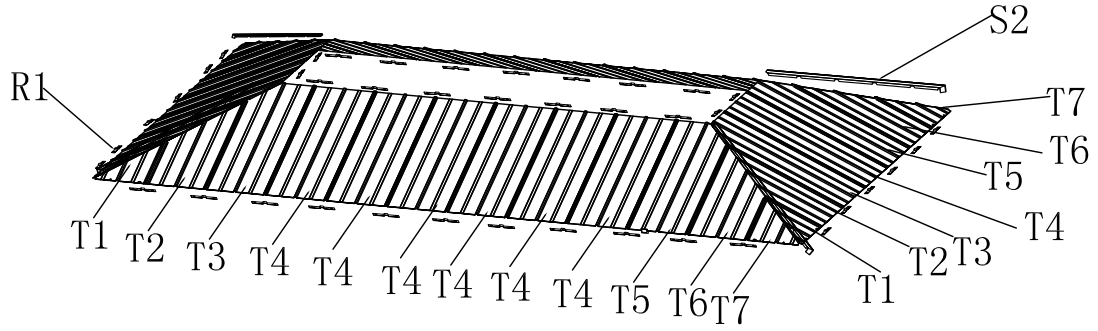
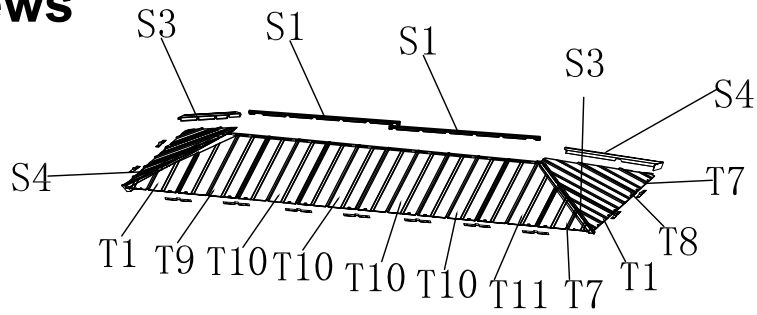

<1>



⑪ 4X



⑫ 2X



⑨ 6X

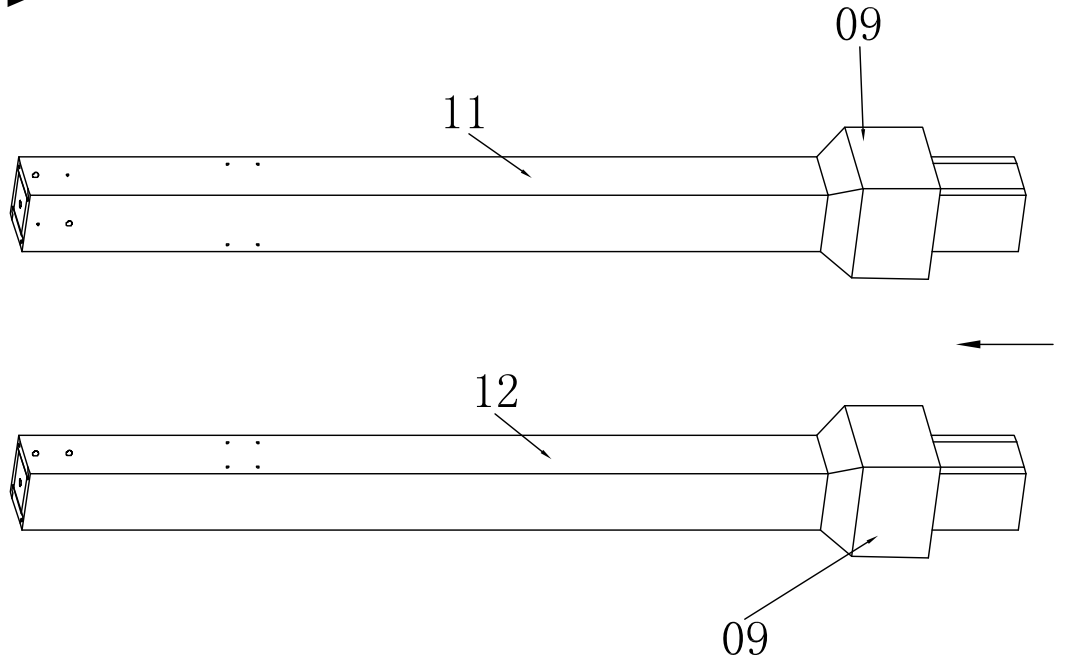

EN: Put base cover **09** through bottom of posts **11/12**.

FR: Placez le couvercle de base **09** au bas des poteaux **11/12**.

<2>

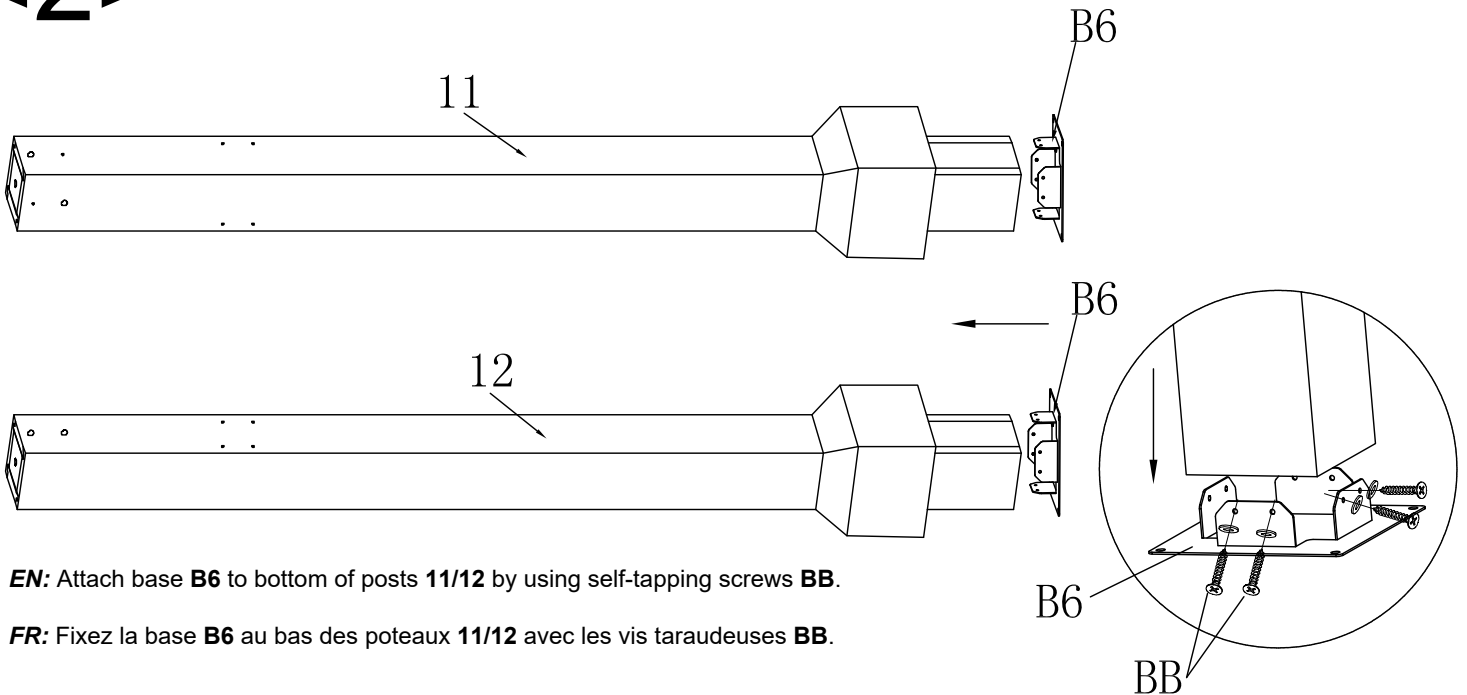

EN: Attach base **B6** to bottom of posts **11/12** by using self-tapping screws **BB**.

FR: Fixez la base **B6** au bas des poteaux **11/12** avec les vis taraudeuses **BB**.



⑬ 6X



⑭ 48X

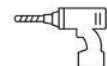

EN: Required drill
FR: Perceuse est nécessaire

<3>

EN: Insert Nut PP into beams **02/04/06/07/10**.

FR: Insérer l'écrou PP dans les poutres **02/04/06/07/10**.

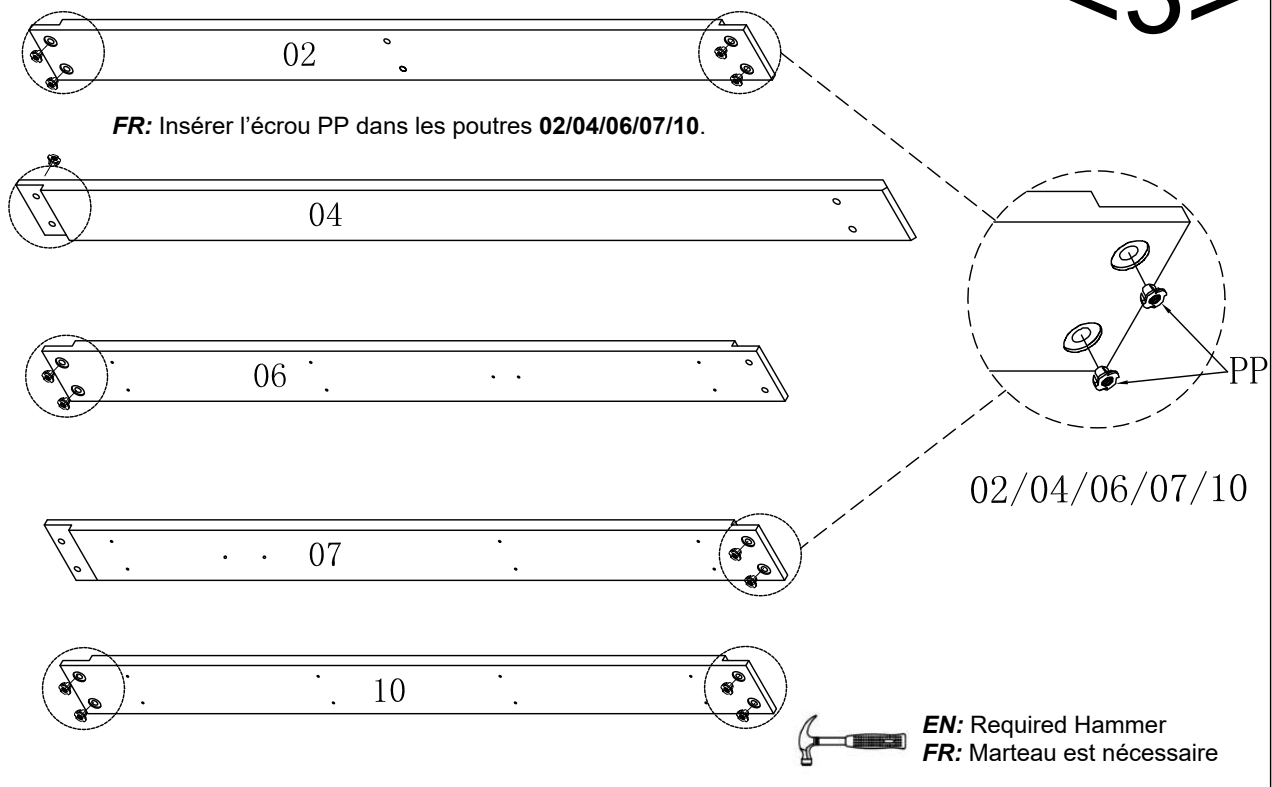
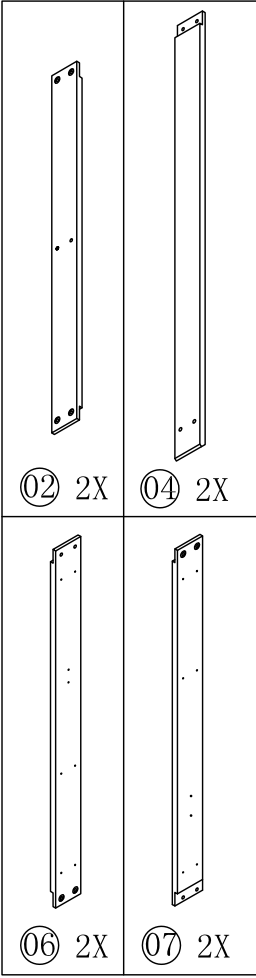

| | | | | |
|-------|-------|-------|-------|--------|
| 06 2X | 07 2X | 10 2X | M8*10 | PP 28X |
|-------|-------|-------|-------|--------|

<4>

EN: Connect short side inner beams **08/10** by using screws **FF**, Connect long side inner beams **05/06/07** by using screws **FF**.

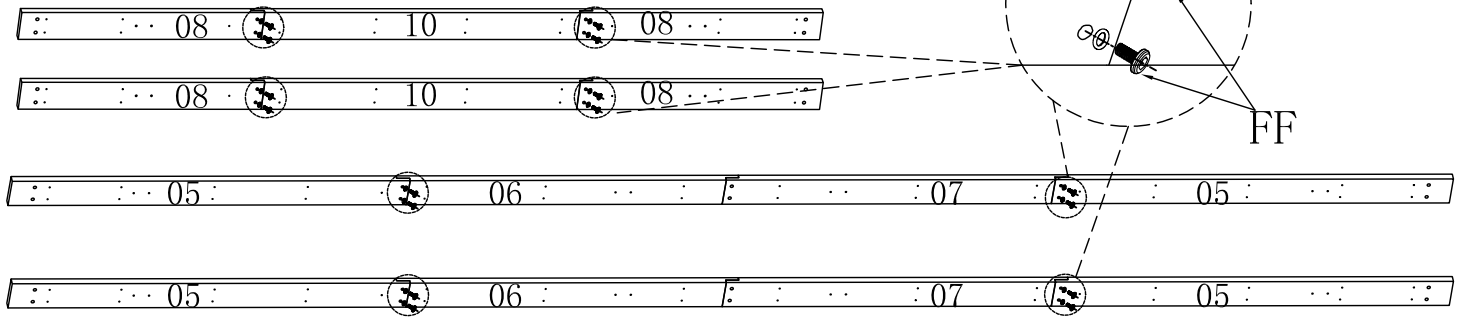

FR: Connectez les poutres intérieures **08/10** du côté court à l'aide de vis **FF**, connectez les poutres intérieures **05/06/07** du côté long avec les vis **FF**.

| | |
|-------|---------|
| 08 4X | 10 2X |
| 06 2X | 07 2X |
| 05 4X | 0 M8*30 |
| | FF 16X |

<5>

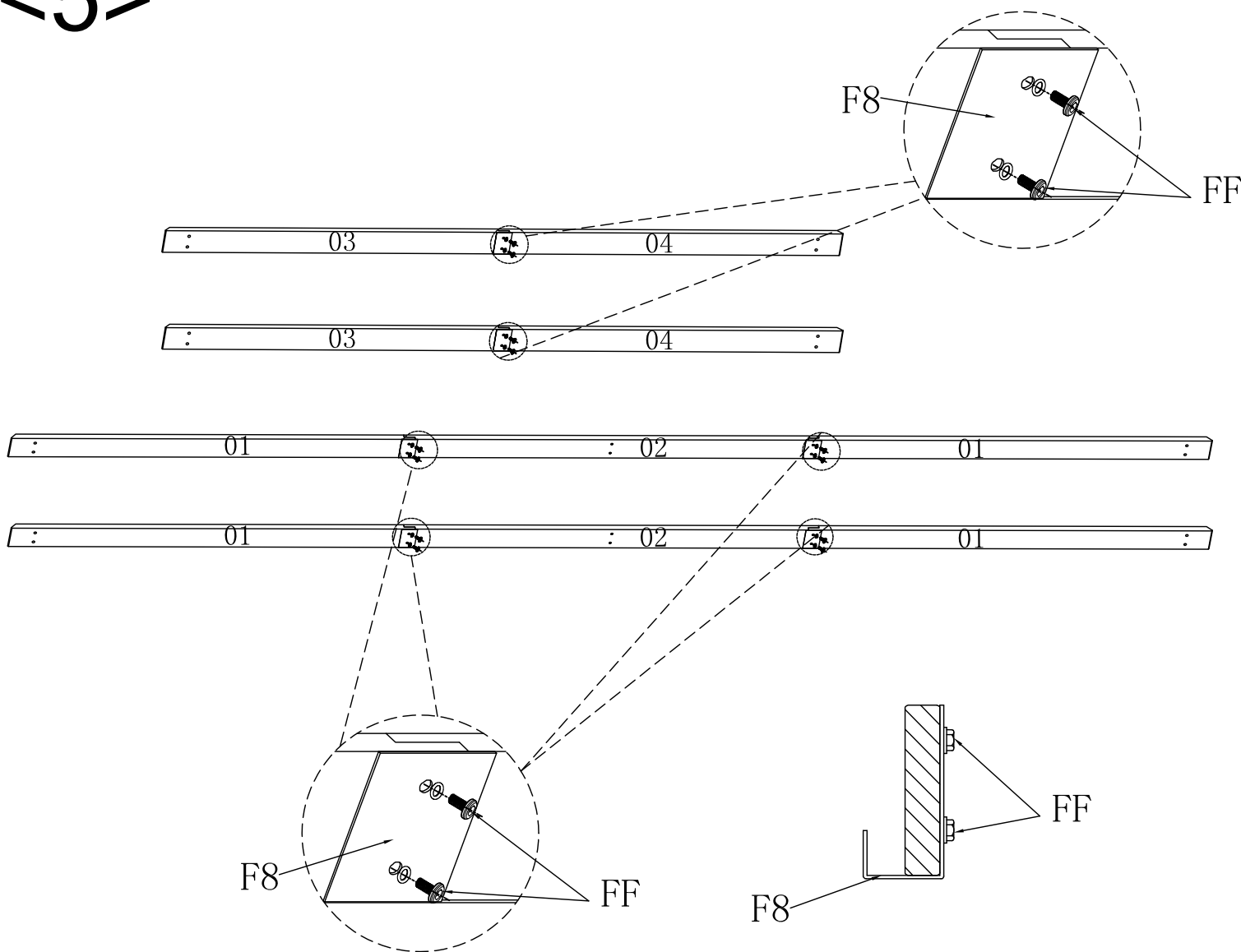

EN: Connect middle covers **F8** with long side outer left/right beam **01/02**, fasten by using screws W/ washer **FF**, Connect middle covers **F8** with short side outer left/right Beam **03/04**, fasten by using screws W/ washer **FF**.

FR: Connectez les couvercles du milieu **F8** avec la poutre extérieure gauche/droite **01/02** de côté long, fixez à l'aide de vis avec rondelle **FF**, connectez les couvercles centraux **F8** avec la poutre extérieure gauche/droite **03/04** de côté court, fixez à l'aide de vis avec rondelle **FF**.



① 4X

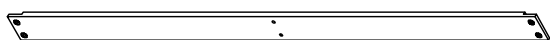

② 2X

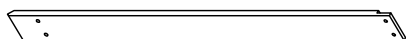

③ 2X

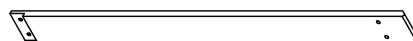

④ 2X



M8*30

ⓕ 12X



ⓕ 6X

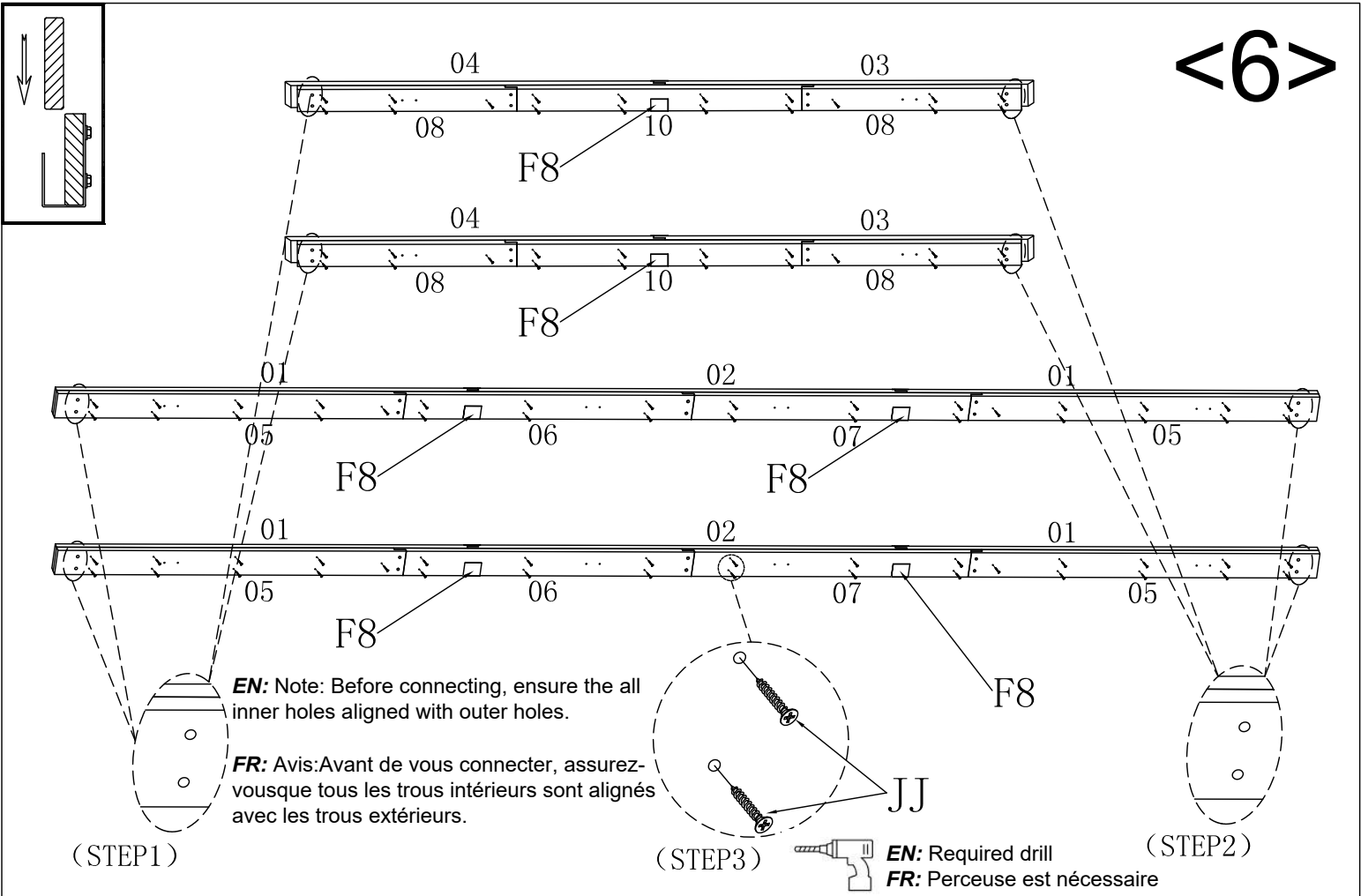

EN: Insert assembled short side inner beams **08/10** into assembled short side outer beams **03/04** by using screw **JJ**, Insert assemble long side inner beam **05/06/07** into assembled long side outer beams **01/02** by using screw **JJ**.

FR: Insérez les poutres intérieures assemblées **08/10** de côté court dans les poutres extérieures assemblées **03/04** de côté court à l'aide d'une vis **JJ**, Insérez l'assemblage de la poutre intérieure **05/06/07** du côté long dans les poutres extérieures assemblées **01/02** de côté long avec les vis **JJ**.

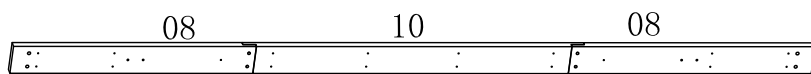

2X

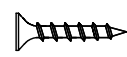

M5*50



96X

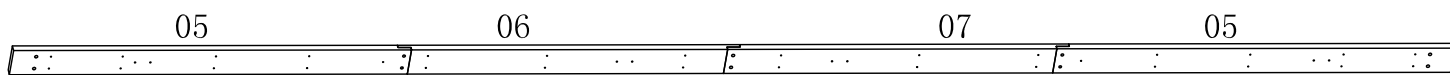

2X

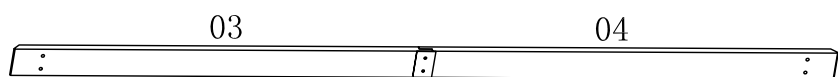

2X



2X

<7>

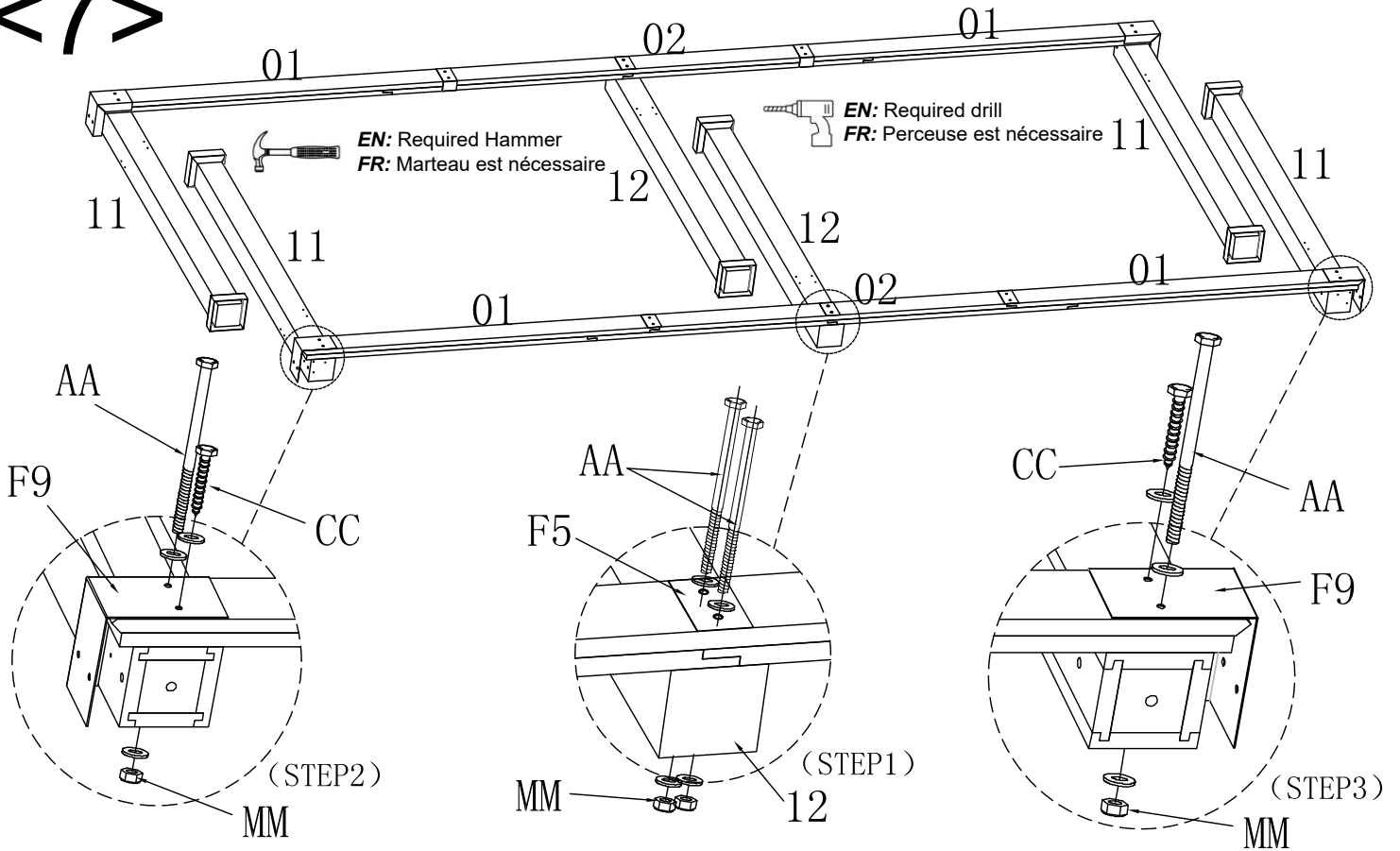

EN: Attach assembled long side beams 01/02//05/06/07 and corner covers F9 to posts 11 by using bolts AA, screws CC, Nuts MM, Attach assembled long side beams 01/02//05/06/07 and middle post plate F5 to posts 12 by using bolts AA, screws CC, Nut MM.

FR: Fixez les poutres latérales longues assemblées 01/02//05/06/07 et les couvercles d'angle F9 aux poteaux 11 en utilisant les boulons AA, vis CC, écrou MM, fixez les poutres latérales longues assemblées 01/02//05/06/07 et la plaque de poteau centrale F5 aux poteaux 12 en utilisant les boulons AA, vis CC, écrous MM.

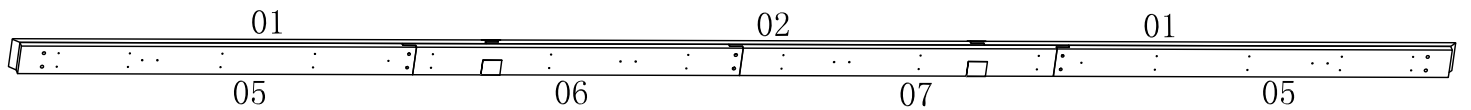

2X

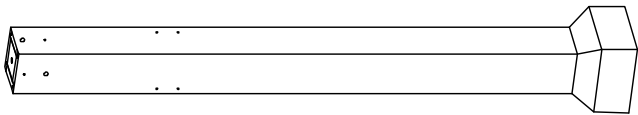

4X

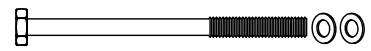

M10*215

Ⓐ

8X

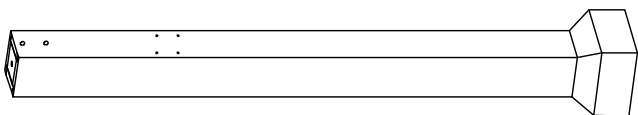

2X

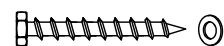

M10*100

Ⓒ

4X

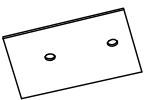

Ⓕ

2X

Ⓜ M10

Ⓜ

8X

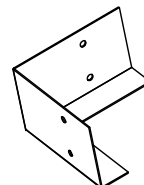

Ⓕ

4X

<8>

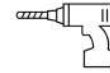

EN: Required drill
FR: Perceuse est nécessaire



EN: Required Hammer
FR: Marteau est nécessaire

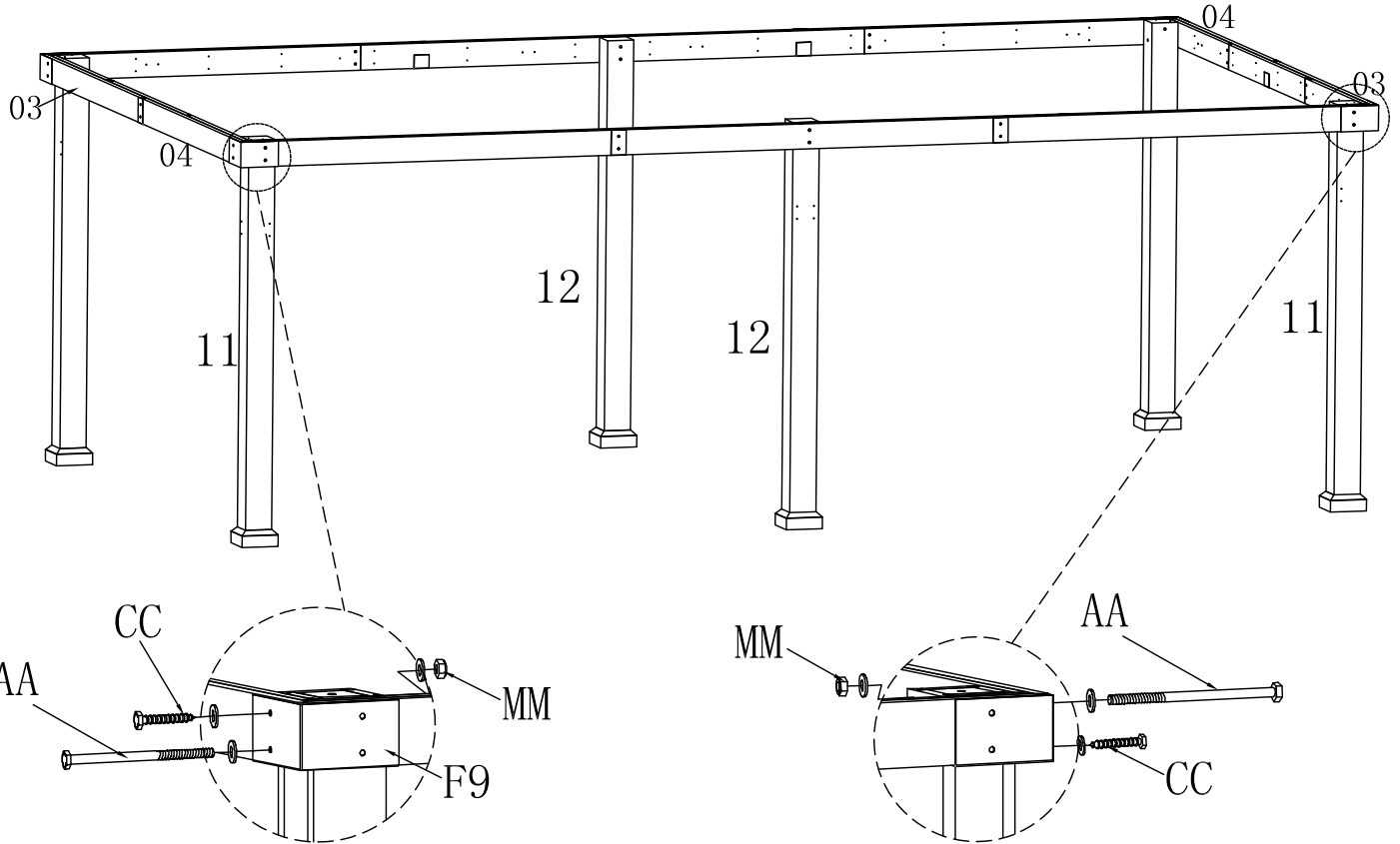

EN: Connect assembled short side beams **03/04/08/10** with assembled corner covers **F9**/long side beams **01/02/05/06/07**/post **11** by using bolts **AA**, screws **CC** w/washers and nuts **MM**.

FR: Connectez les poutres latérales courtes assemblées **03/04/08/10** avec les couvercles d'angle assemblés **F9**/poutres latérales longues **01/02/05/06/07**/poteaux **11** en utilisant des boulons **AA**, des vis **CC** & rondelles et des écrous **MM**.

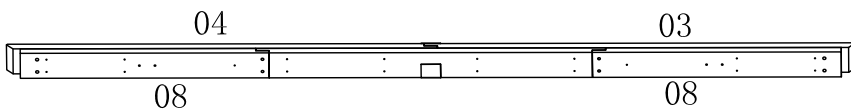

2X

M10

4X

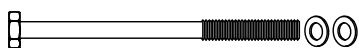

M10*215

4X

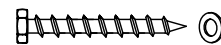

M10*100

4X

<9>

EN: Attach left/right supports **13/14** to assembled beams and posts **11/12** by using self-tapping screws **DD**.

FR: Fixez les supports gauche/droite **13/14** aux poutres et poteaux assemblés **11/12** avec les vis taraudeuses **DD**.

D1=D2

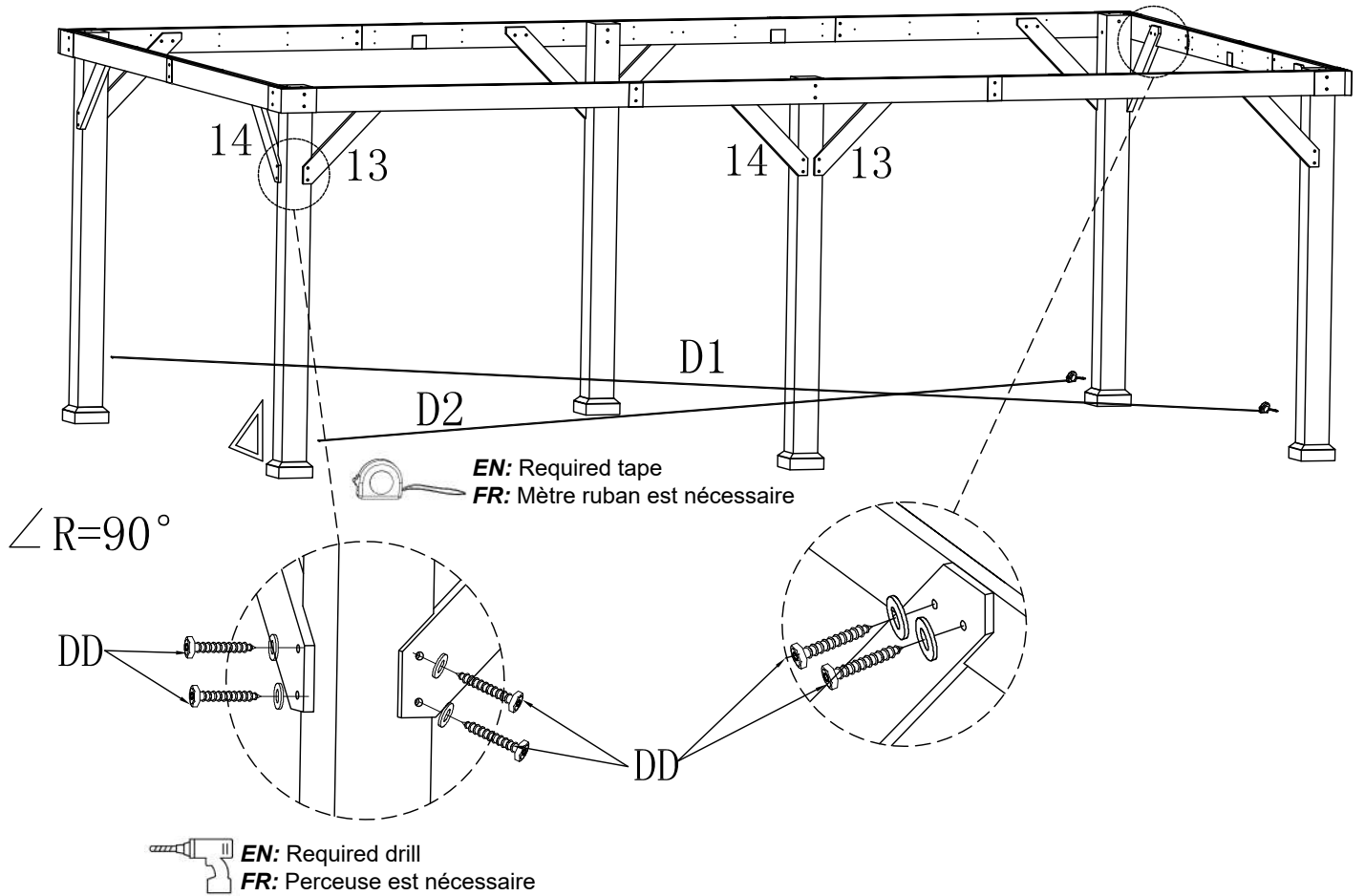

EN: Note: Make sure the distances are equal between two diagonals of posts by using tape before to next assemble step. Keep the beam at right angles to the post, the post at right angles to the ground, and keep the beam horizontal.

FR: Avis: Assurez-vous que les distances sont égales entre deux diagonales de poteaux en utilisant du ruban à mesurer avant l'étape suivante d'assemblage. Maintenez la poutre perpendiculaire au poteau, le poteau perpendiculairement au sol et maintenez la poutre horizontale.

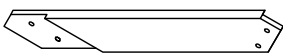

⑬ 6X

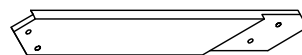

⑭ 6X



M8*40 ①① 48X

<10>

EN: Attach long side curtain bars **E3** and short side curtain bars **E1** to assembled beams, fix by using self-tapping screws **EE**.

Note: ensure the distance from edge of long side curtain bar **E3**/short side curtain bar **E1** to the post **11/12** is 1.2 inch.

FR: Fixer les barres à rideau **E3** de long côté et les barres rideaux **E1** de côté court aux poutres assemblées, fixer avec les vis taraudeuses **EE**.

Avis: assurer que la distance entre le bord de la barre de rideau **E3** du côté long/barre rideau **E1** du côté court et le poteau **11/12** est de 1.2".

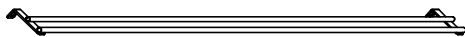
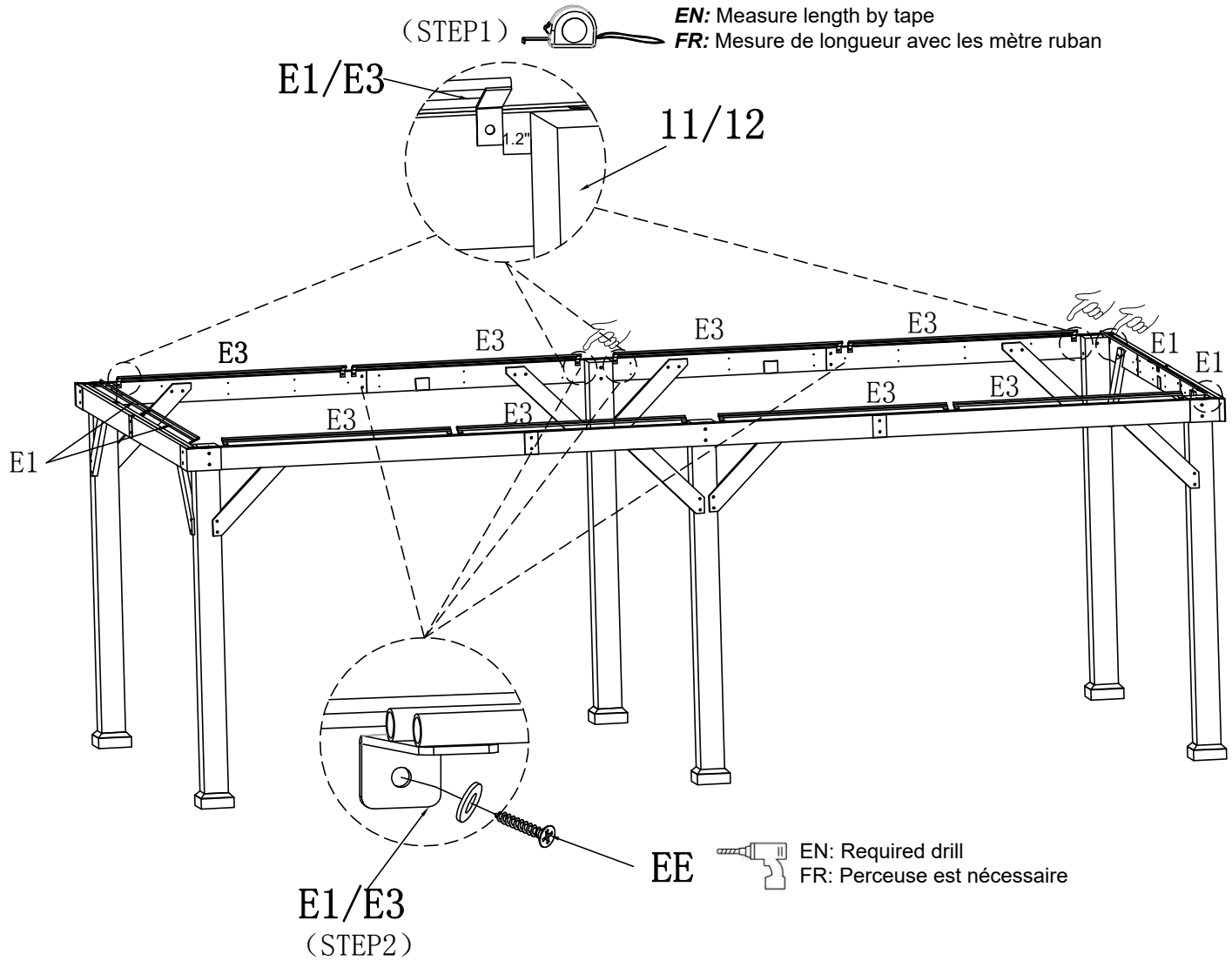

E1 4X

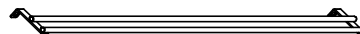

E3 8X

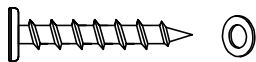

M5*40 **EE** 24X

<11>

EN: Attach slant beam bottom connectors **G5** to the top of posts **11** by using self-tapping screws **EE**.

FR: Fixez les connecteurs inférieurs inclinés **G5** au sommet des poteaux **11** avec les vis taraudeuses **EE**.

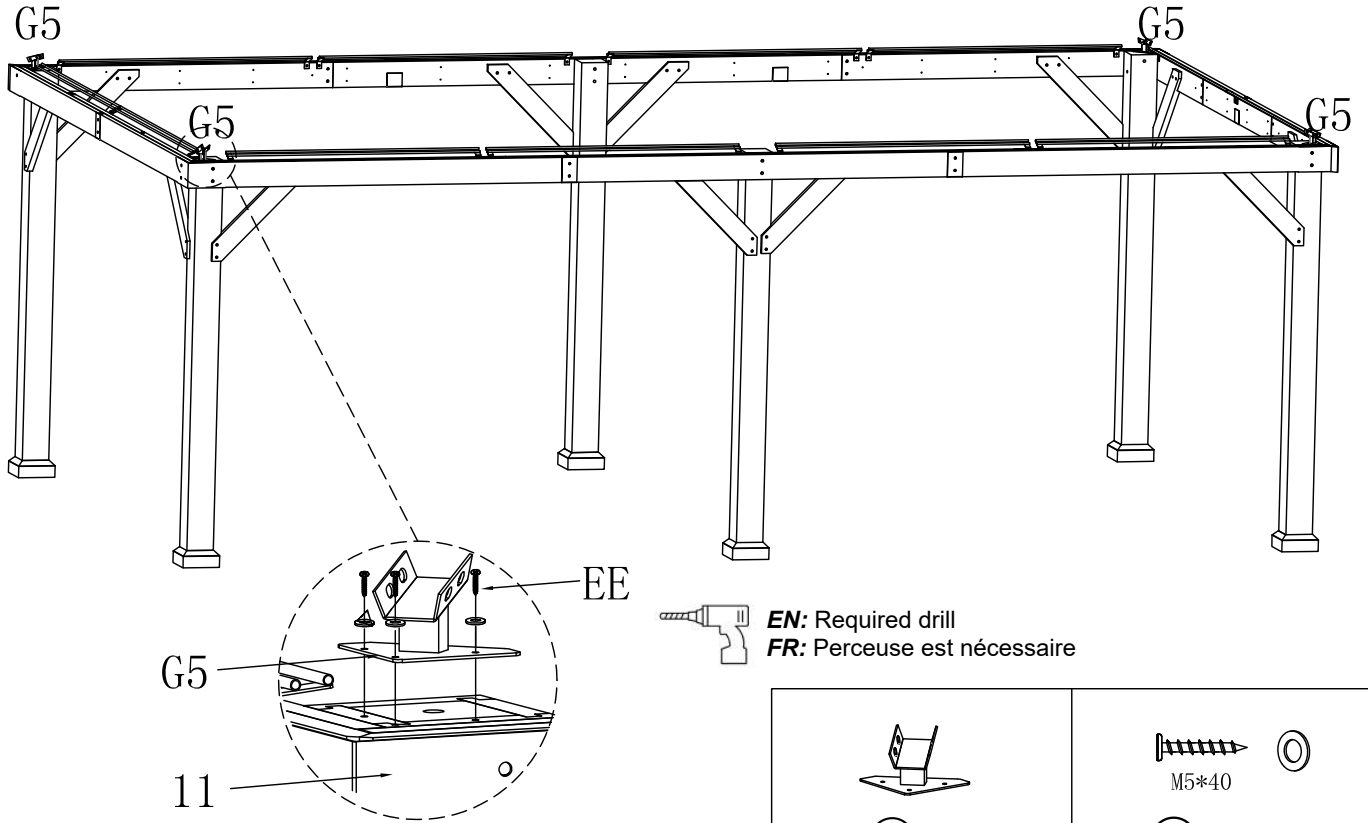

EN: Required drill
FR: Perceuse est nécessaire

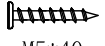

| | |
|---|---|
|  G5 4X |  M5*40 EE 12X |
|---|---|

<12>

EN: Connect long side tubes of big roof **I1/I2** with the inner bracket of big roof **P1** by using screws **TT**.

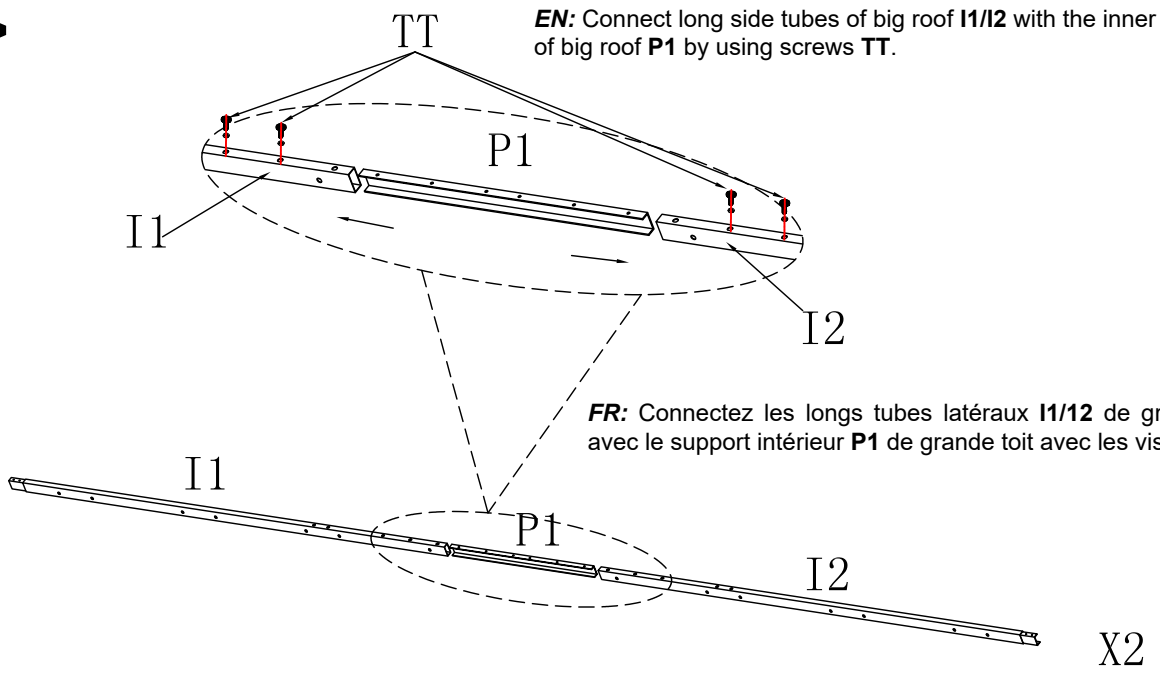
FR: Connectez les longs tubes latéraux **I1/I2** de grand toit avec le support intérieur **P1** de grande toit avec les vis **TT**.

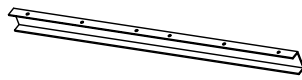
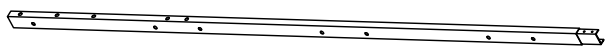

| | |
|--|---|
|  I1 2X |  P1 2X |
|  I2 2X |  M6*15 TT 8X |

<13>

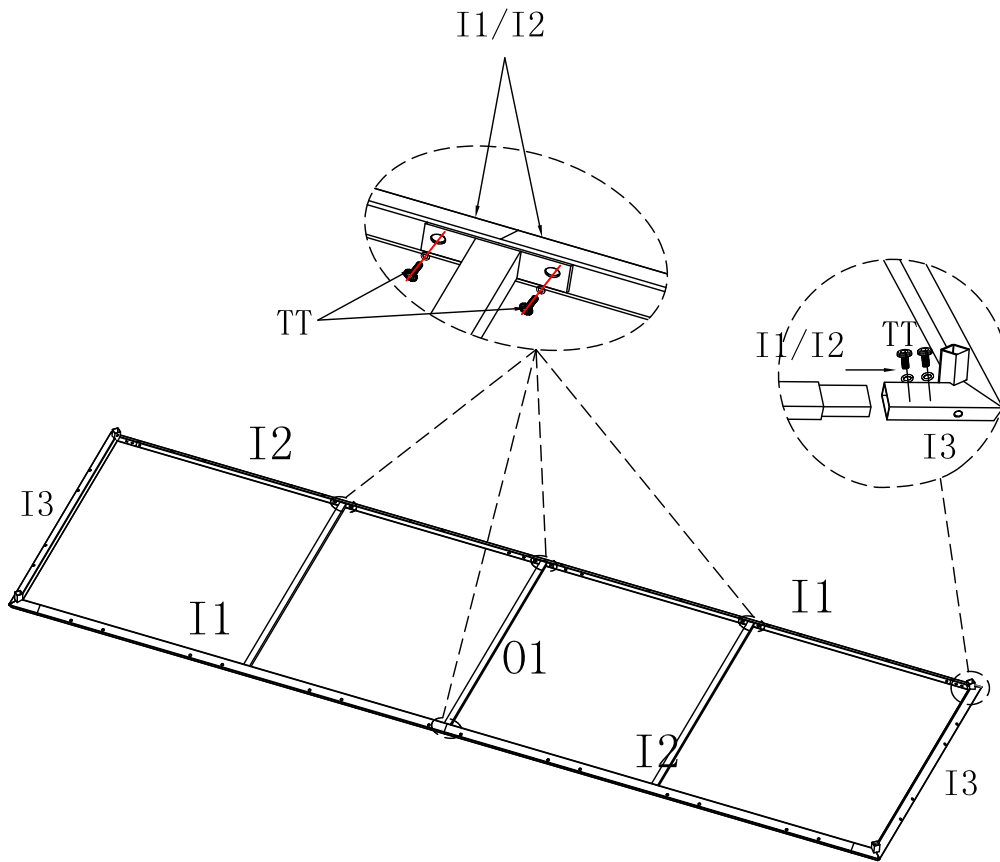

EN: Connect short side tubes **I3** of big roof and middle tubes **O1** of big roof with the long side assembled tubes **I1/I2** of big roof by using screws **TT**.

FR: Connectez les tubes latéraux courts **I3** de grand toit et le tubes central **O1** de grand toit avec les tubes longs assemblés latéralement **I1/I2** de grand toit avec les vis **TT**.

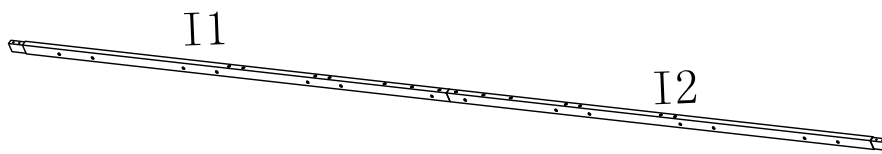

2X



⓪1 3X

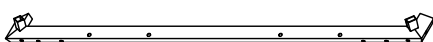

⓪3 2X



⓪TT 20X

<14>

EN: Connect top of big roof beams **H1** with the assembled frame **I1/I2/I3** of big roof by using screws **TT**.

FR: Connecter le haut des poutres **H1** de grand toit avec le cadre assemblé **I1/I2/I3** de grand toit avec les vis **TT**.

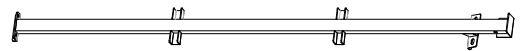
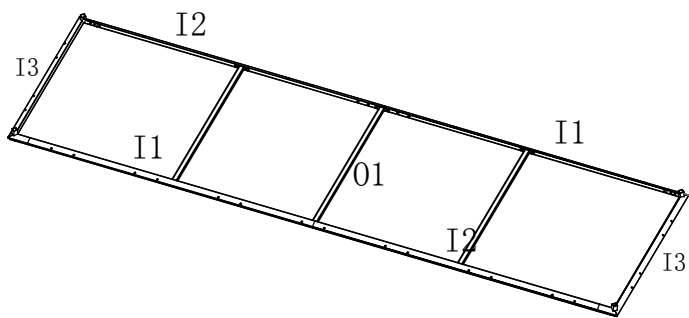
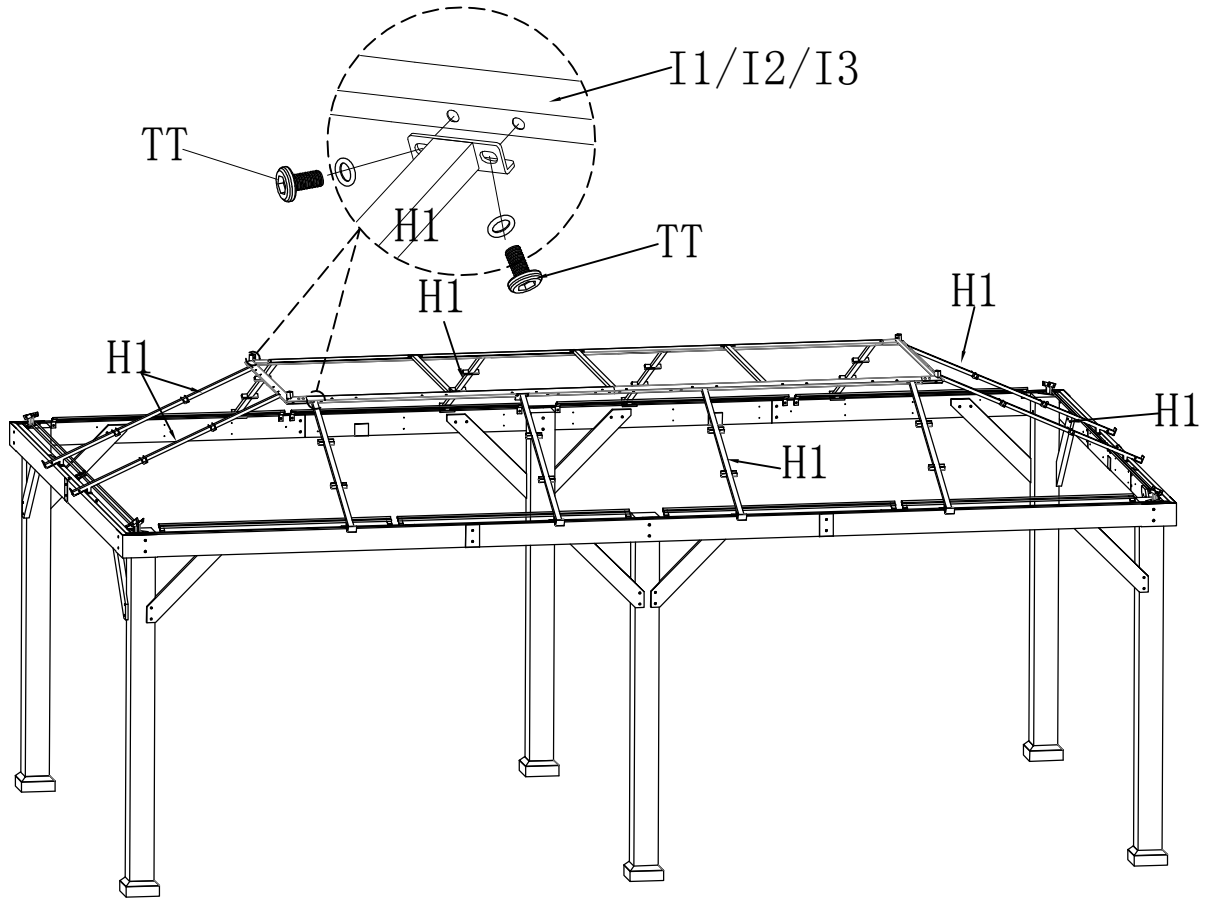

(H1) 12X

TT M6*15

1X

(TT) 24X

<15>

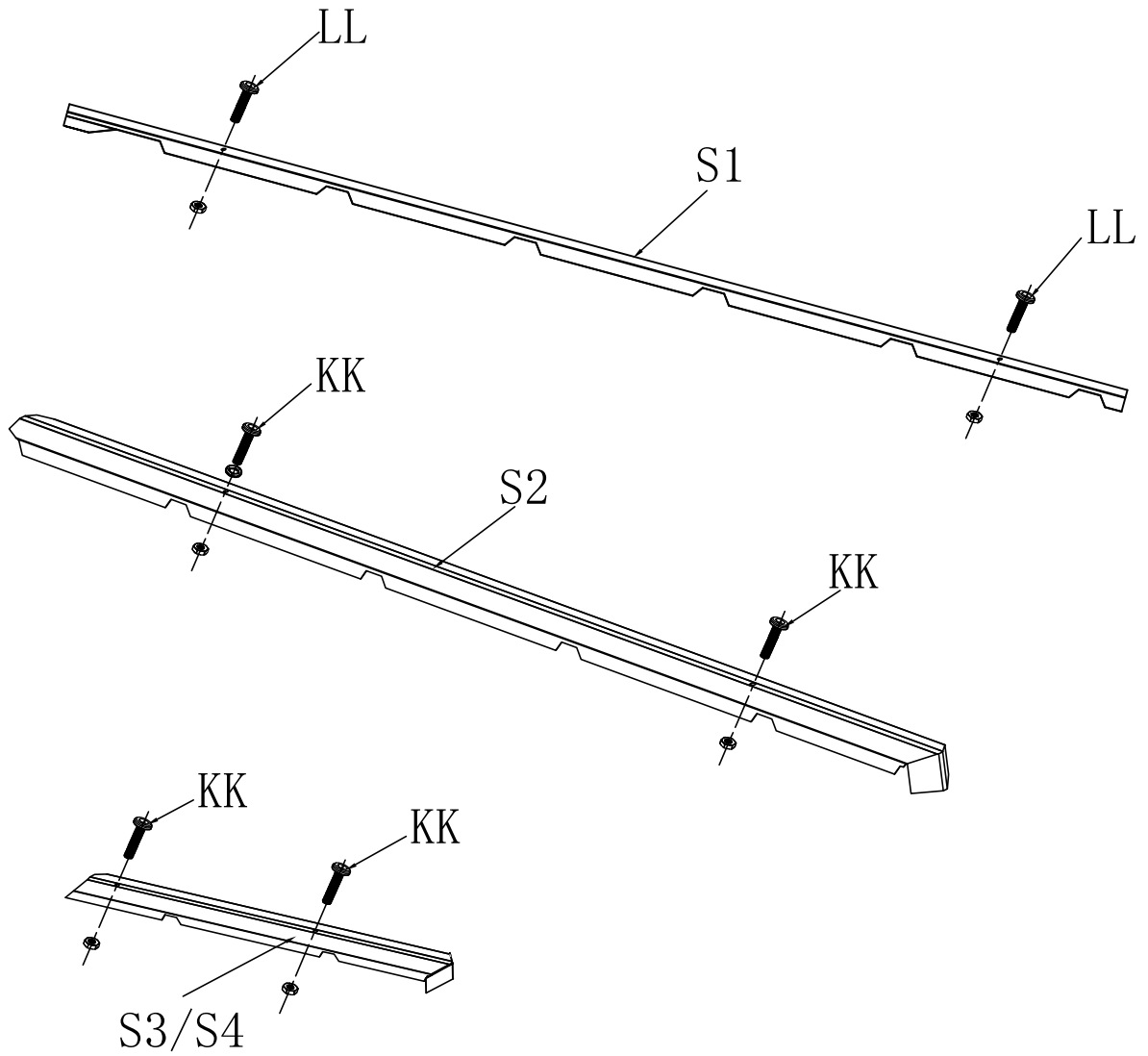

EN: Insert the screws **LL/KK** into the hole of small roof covers **S1**/Big roof slant covers **S2**/Small roof slant covers **S3/S4**, and secure it with nuts.

FR: Insérez les vis **LL/KK** dans le trou des petits couvercles de toit **S1**/Grandes couvertures inclinées de toit **S2**/Petites couvertures inclinées de toit **S3/S4** et fixez-les avec des écrous.



Ⓢ1 2X

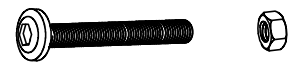

ⓁⓁ 4X M6*75

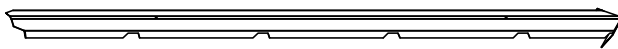

Ⓢ2 4X



ⓀⓀ 16X M6*55

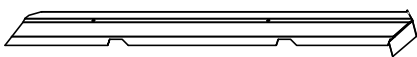

Ⓢ3 2X

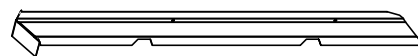

Ⓢ4 2X

<16>

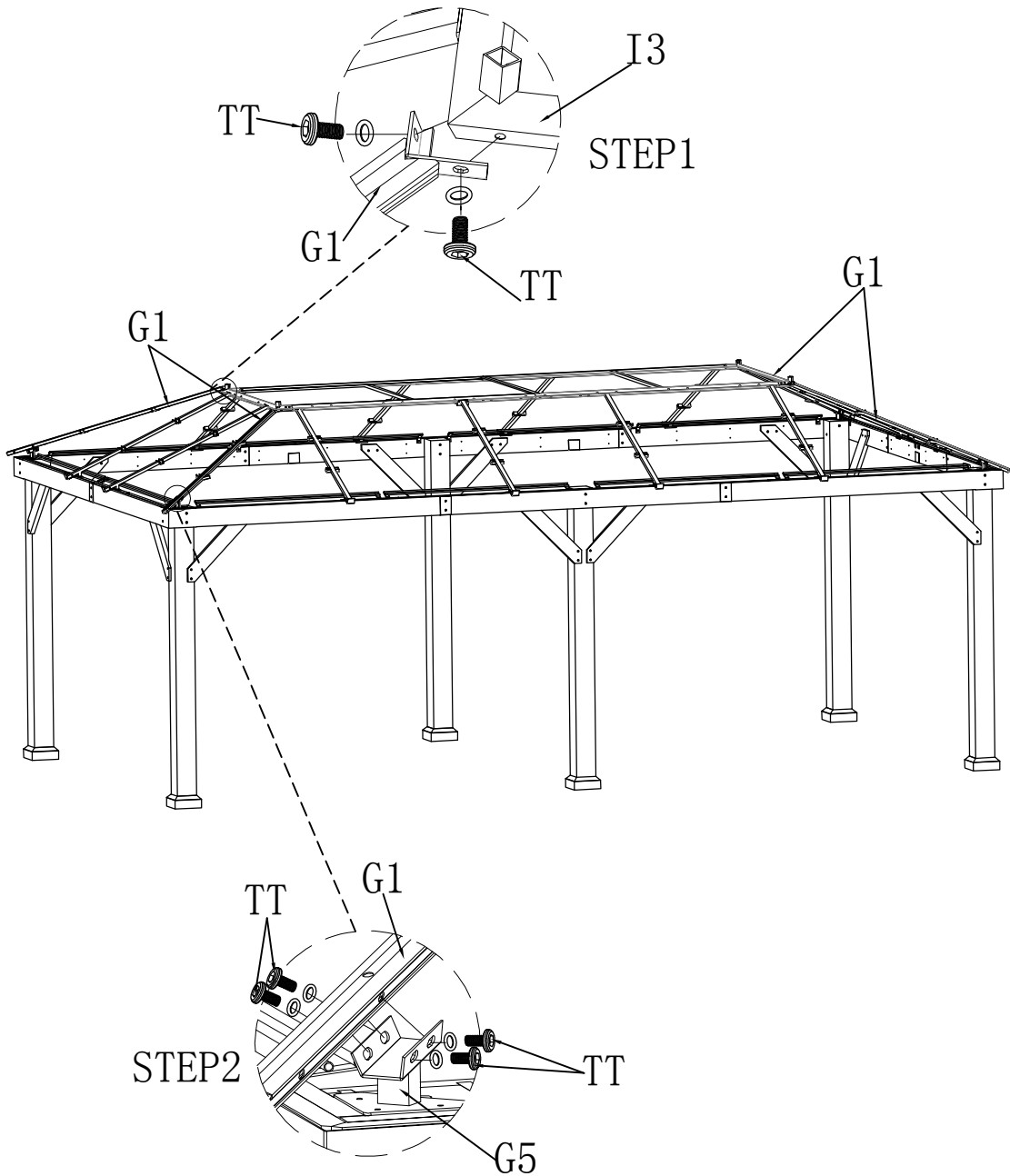

EN: Connect bottom of long slant beam **G1** with slant beam bottom connector **G5** by using screws **TT**, then connect top of long slant beam **G1** with the short /long side tubes **I3/I2/I1** of big roof by using screws **TT**.

FR: Connectez le bas de la poutre inclinée longue **G1** avec le connecteur inférieur de la poutre inclinée **G5** à l'aide de vis **TT**, puis connectez le haut de la longue poutre inclinée **G1** avec les tubes latéraux courts/longs **I3/I2/I1** du grand toit avec les vis **TT**.



 M6*15

G1 4X

TT 24X

<17>

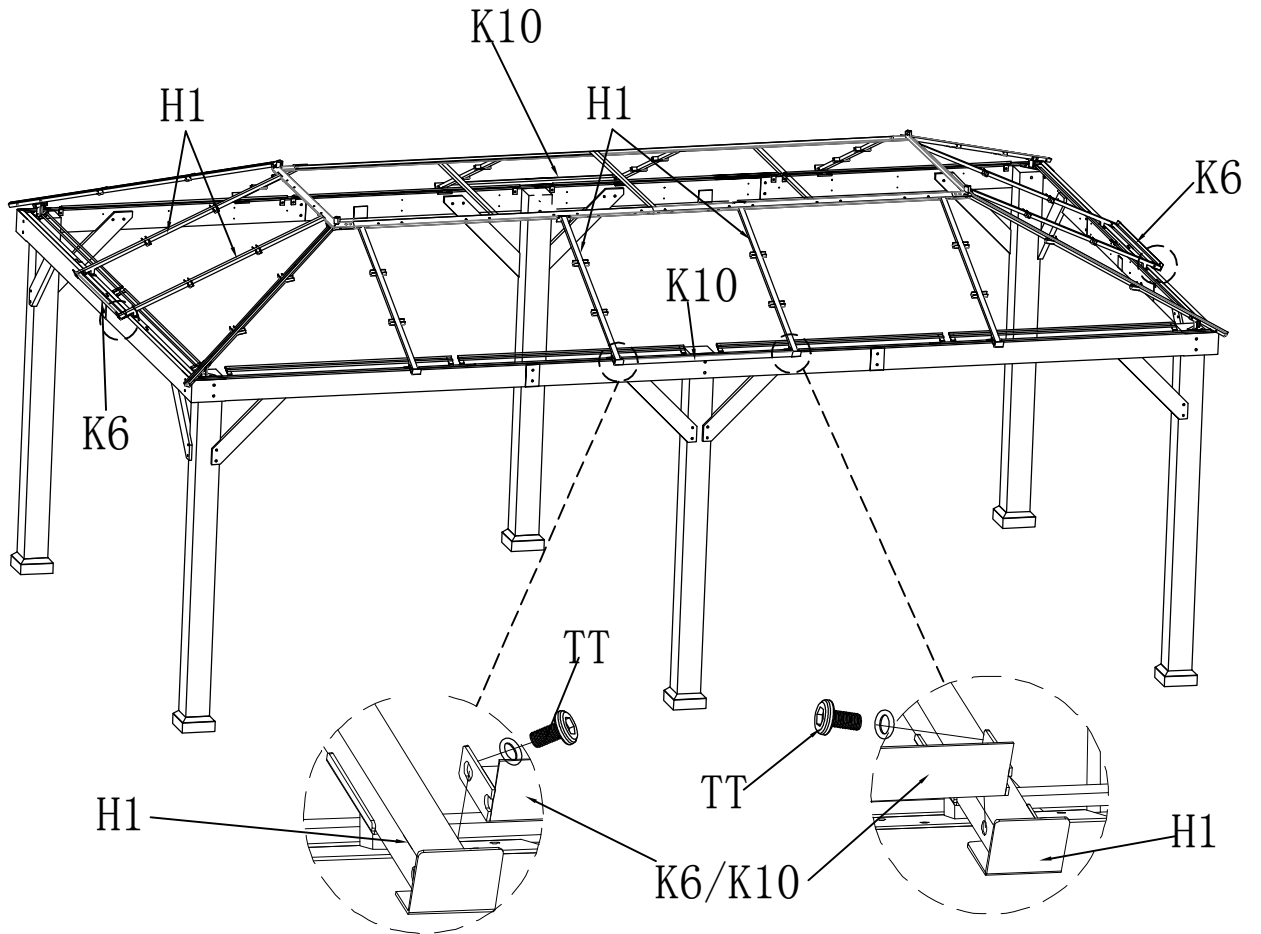

EN: Insert two ends of big roof short side/long side middle blocking bar **K6/K10** to the bottom of big roof short side beams **H1** and big roof long side beams **H2** by using screws **TT**.

FR: Insérez deux extrémités de barre de blocage centrale latérale courte/latérale longue **K6/K10** de grand toit au bas des poutres latérales courtes **H1** de grand toit et les poutres latérales longues **H2** de grand toit avec les vis **TT**.

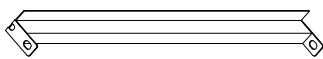

(K6) 2X

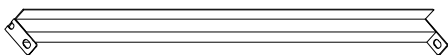

(K10) 2X



M6*15

(TT) 8X

<18>

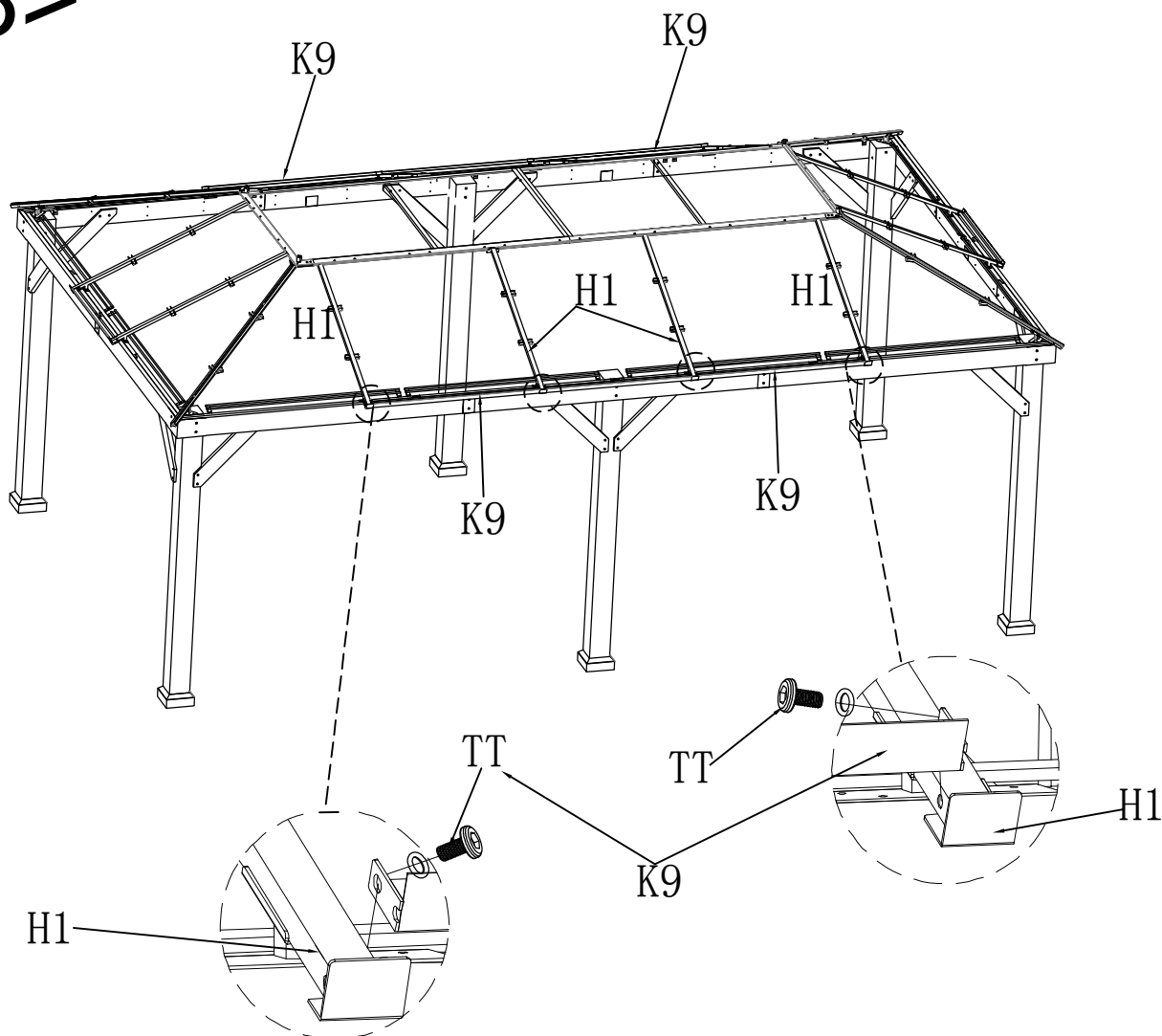

EN: Insert two ends of big roof middle blocking bar **K9** to the bottom of big roof side beams **H1** and big roof middle beams **H2** by using screws **TT**.

FR: Insérez deux extrémités de barres de blocage centrales **K9** de grand toit au bas des poutres latérales **H1** de grand toit et les poutres centrales **H2** de grand toit avec les vis **TT**.

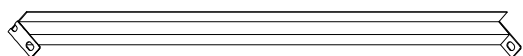

(K9) 4X



© M6*15

(TT) 8X

<19>

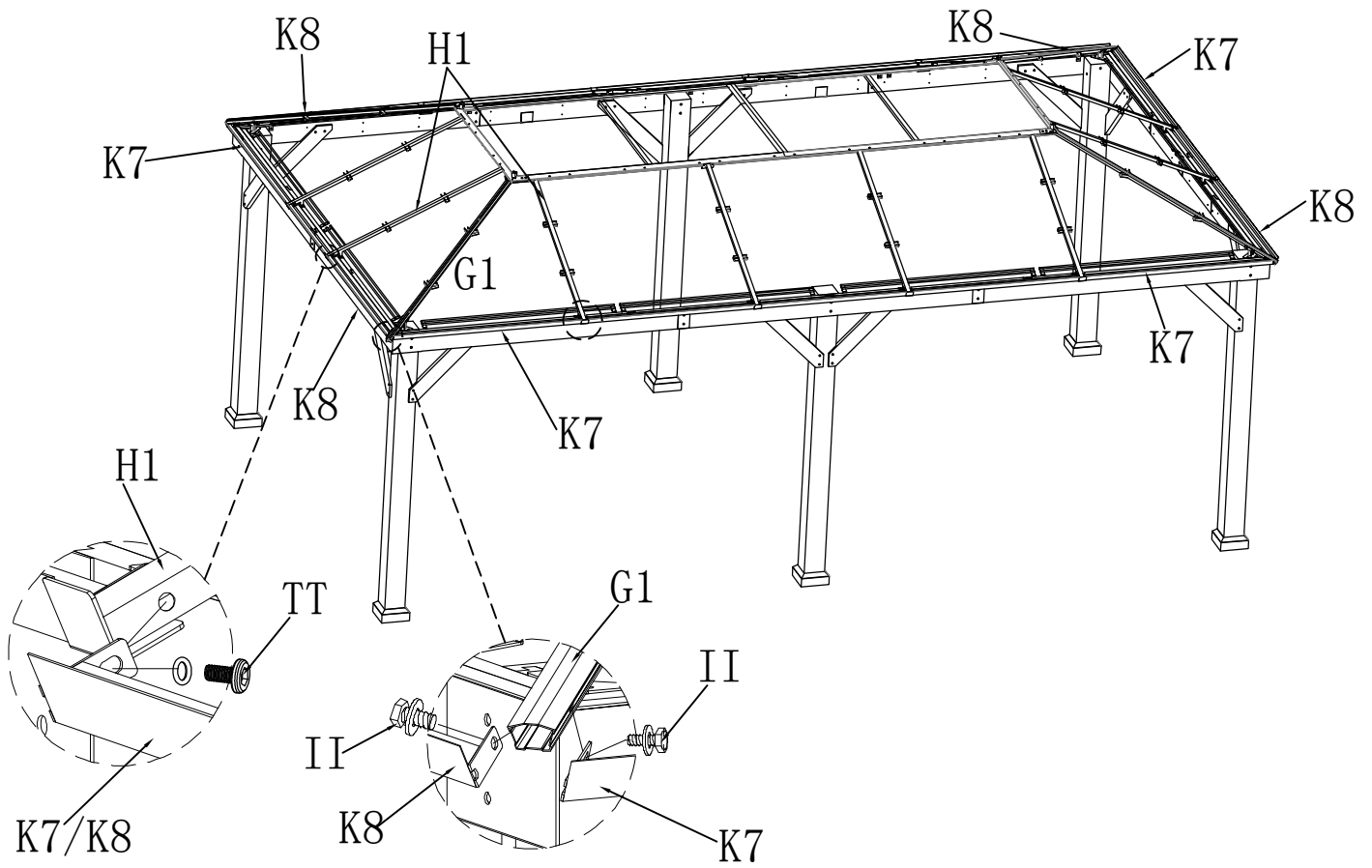

EN: Insert two ends of big roof left/right blocking bar **K7/K8** to the bottom of big roof beams **H1** and big roof slant beams **G1** by using screws **TT**/bolts **II**.

FR: Insérez deux extrémités de grande barre de blocage gauche/droite **K7/K8** de grand toit au bas de la poutre **H1** du grand toit et de la poutre inclinée **G1** du grand toit avec les vis **TT**/boulons **II**.

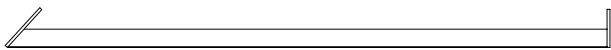

Ⓚ7 4X



M6*15

ⓀII 8X

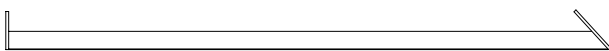

Ⓚ8 4X



M6*15

ⓀTT 8X

<20>

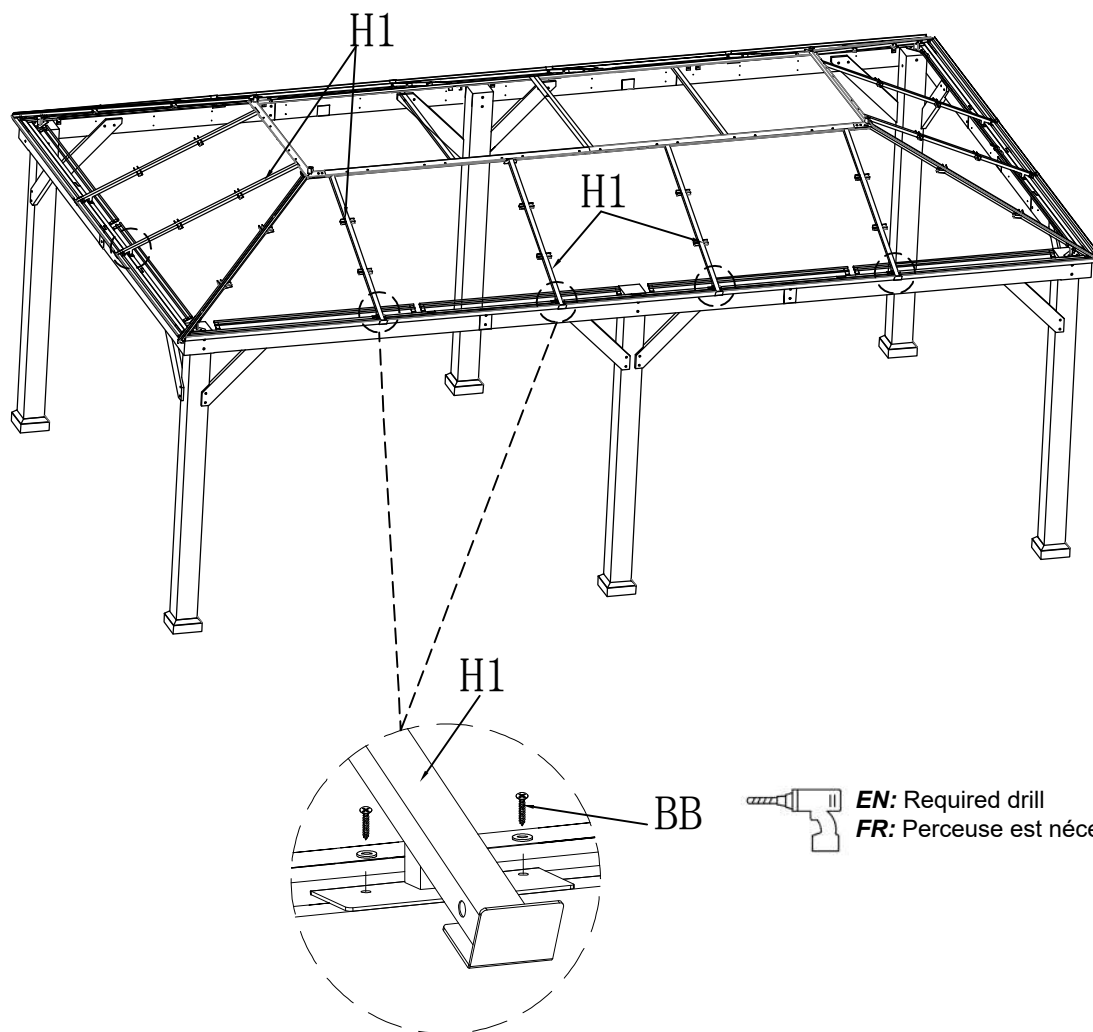

 **EN:** Required drill
FR: Perceuse est nécessaire

EN: Connect bottom of big roof side/middle beams **H1/H2** with assembled beams frame by using self-tapping screws **BB**.

FR: Connectez le bas des grandes poutres latérales/centrales **H1/H2** au cadre des poutres assemblées avec les vis **BB**.

  M5*25

 24X

<21>

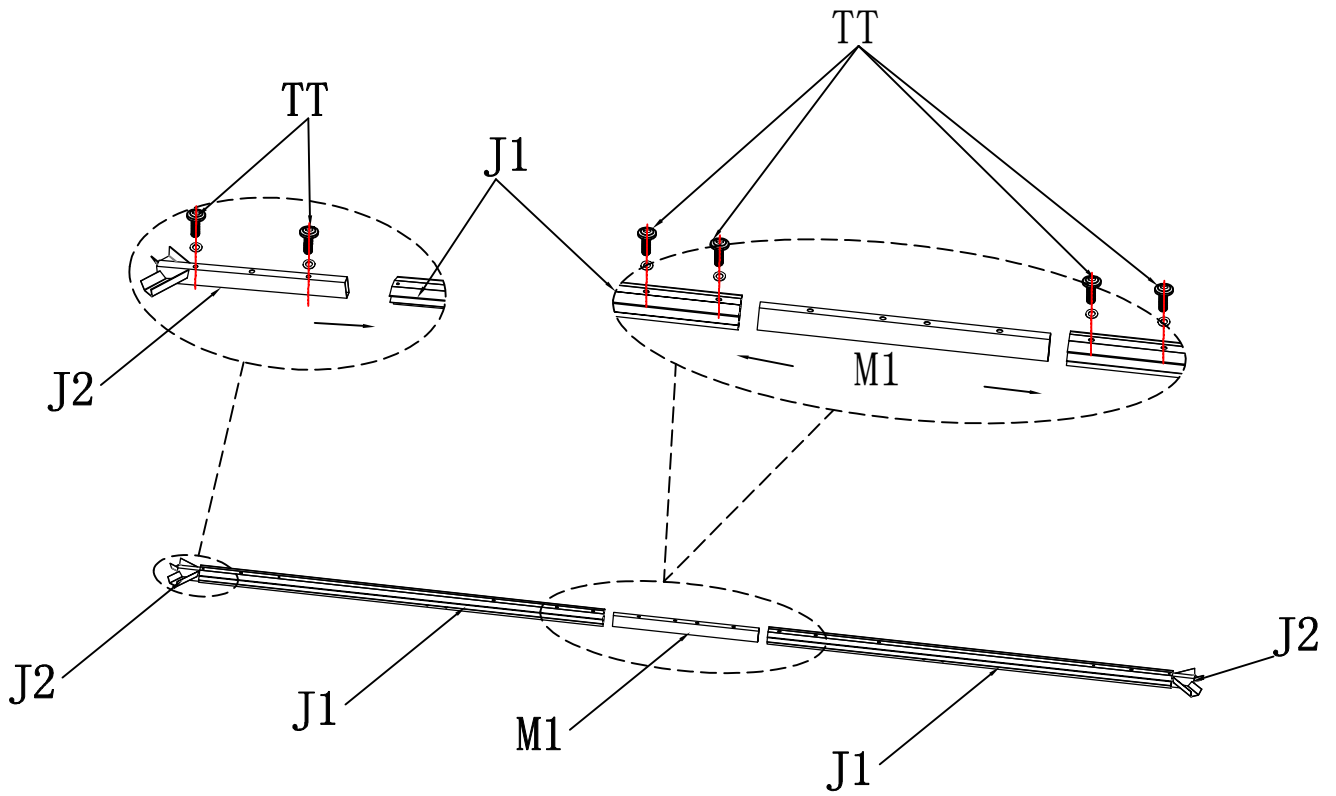

EN: Connect small roof side connectors **J2**, small roof long connectors **J1** with small roof inner bracket **M1** by using screws **TT**.

FR: Connecter les connecteurs latéraux **J2** de petit toit, les connecteurs longs **J1** de petit toit avec support intérieur **M1** de petit toit avec les vis **TT**.



Ⓧ 2X



Ⓧ 1X

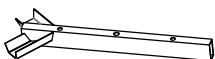

Ⓧ 2X



M6*15

Ⓧ 8X

<22>

EN: Insert bottom of small roof slant beam **L1** into big roof assembled frame **I3**, then insert upper of small roof slant beam **L1** into small roof side connector **J2** by using screws **TT**.

FR: Insérer le bas de la poutre oblique **L1** de petit toit dans le cadre assemblé **I3** de grand toit, puis insérer la partie supérieure de la poutre oblique **L1** de petit toit dans le connecteur latéral **J2** de petit toit avec les vis **TT**.

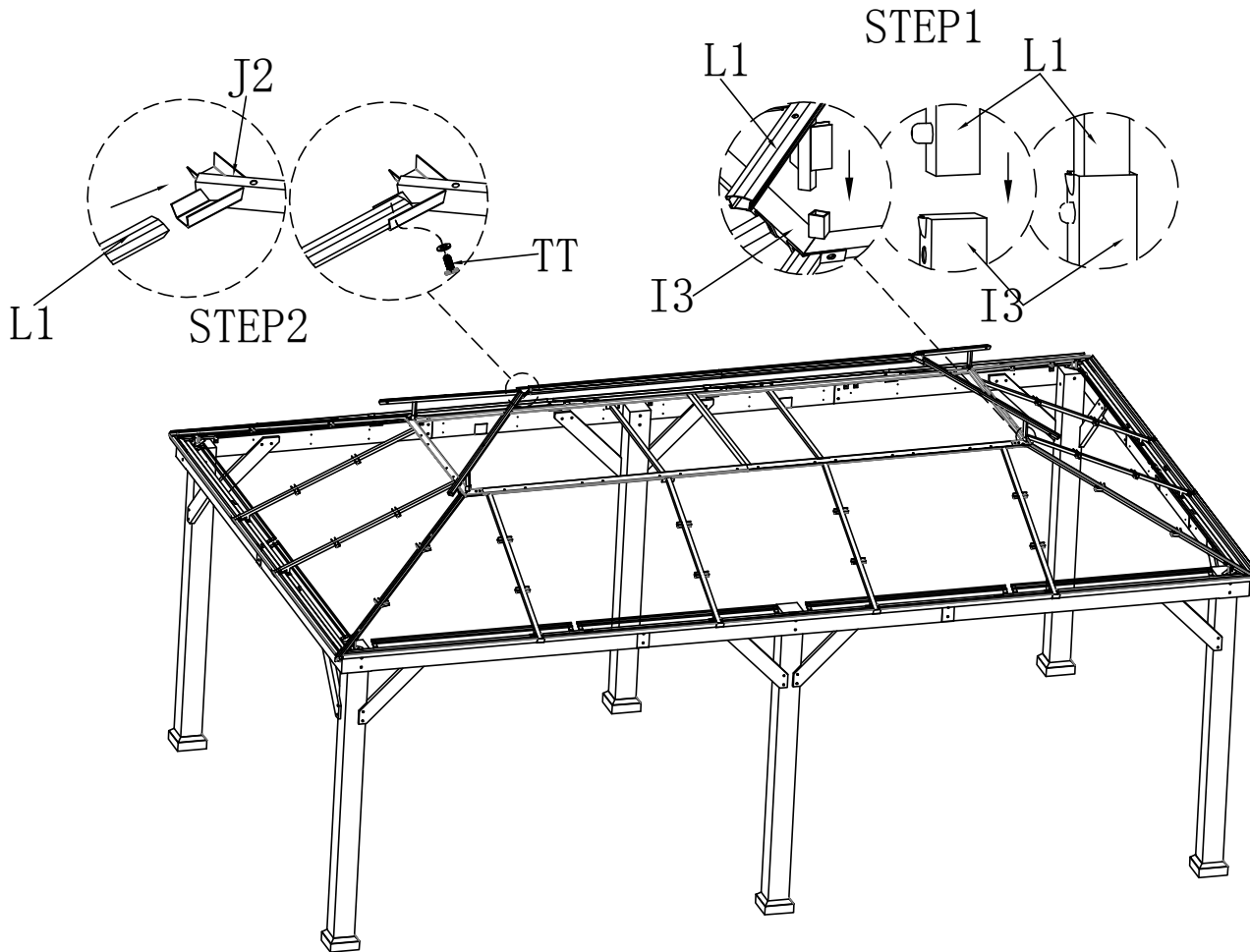

(L1) 4X



(TT) 4X

<23>

EN: Connect small roof top beam **H3** with bottom connector **H2**, fasten by using screws W/ nuts **NN**.

FR: Connectez la petite poutre de toit **H3** avec le connecteur inférieur **H2**, fixez à l'aide de vis avec des écrous **NN**.

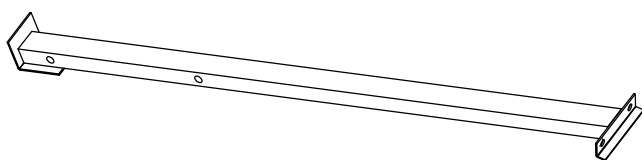
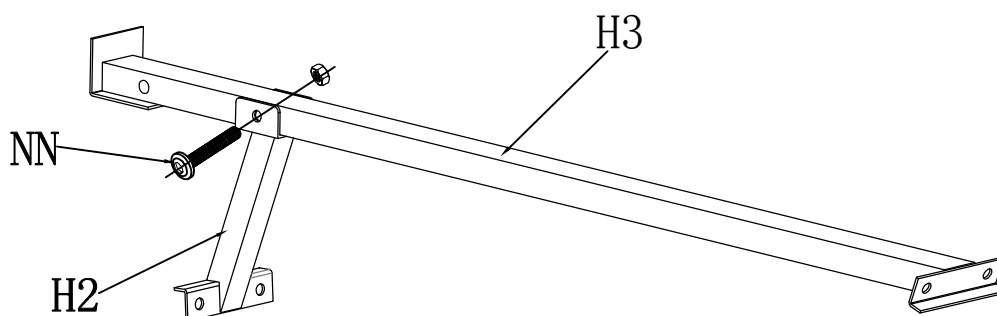

ⓂH3 4X



ⓂH2 4X



M6*45

ⓂNN 4X

<24>

EN: Attach small roof top beams **H3** to small roof connector **J1** and big roof long tubes **I1/I2** by using screws **TT**.

FR: Fixer les poutres supérieures **H3** de petit toit au petit connecteur de toit **J1** et les longs tubes **I1/I2** de grand toit avec les vis **TT**.

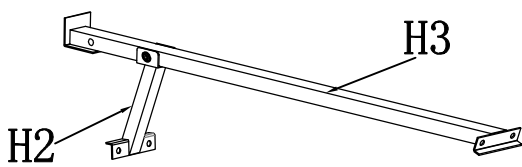
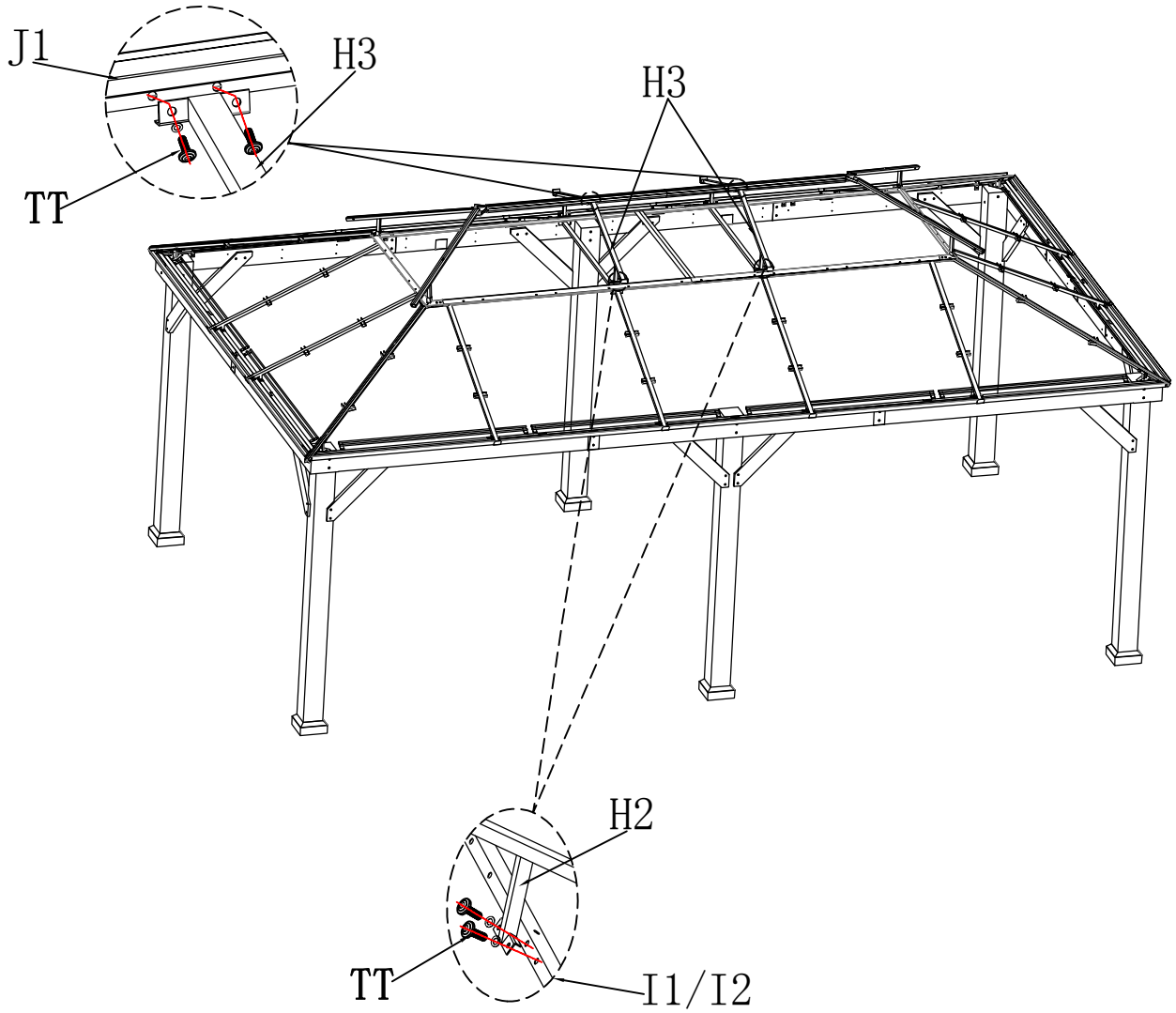

4X



M6*15



16X

<25>

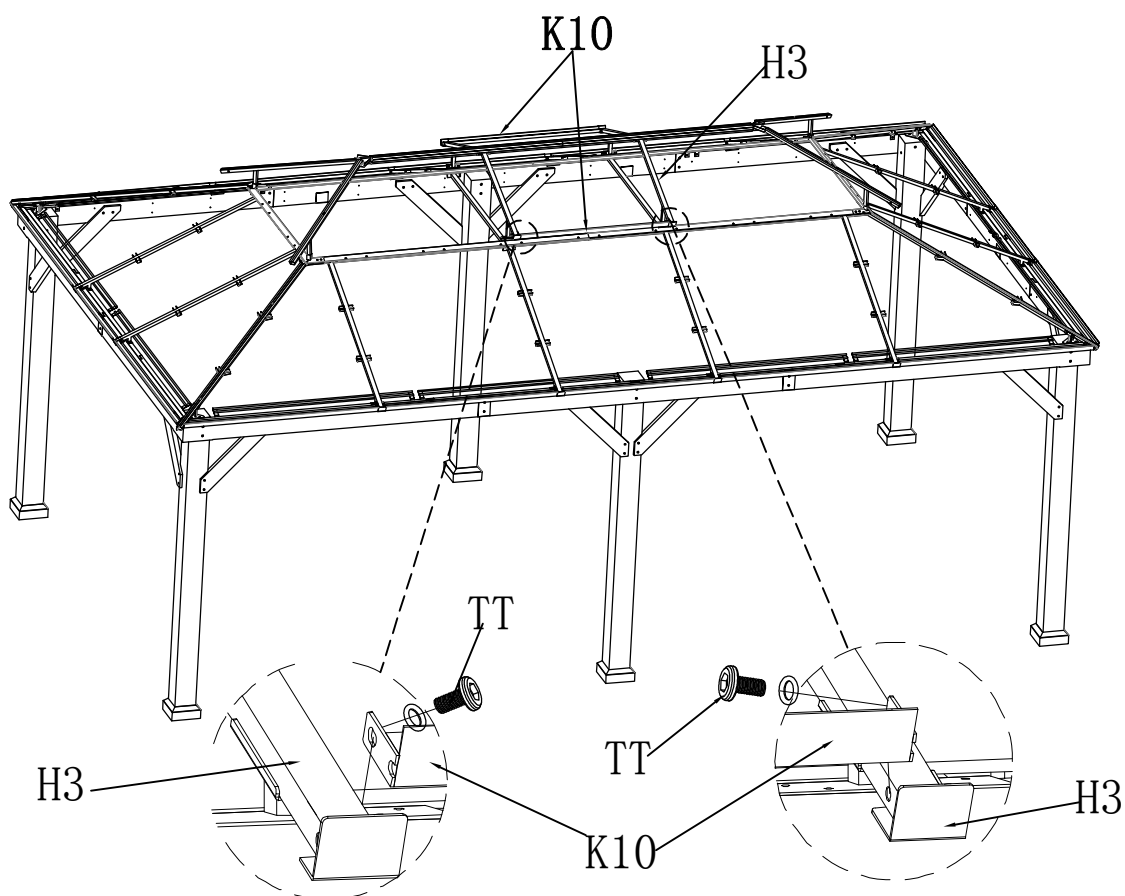

EN: Attach small roof middle blocking bar **K10** to small roof top beams **H3** by using screws **TT**.

FR: Fixer la barre de blocage centrale **K10** de petite toiture aux poutres supérieures **H3** de petite toit avec les vis **TT**.

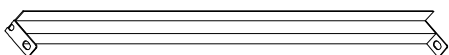

(K10) 2X



M6*15

(TT) 4X

<26>

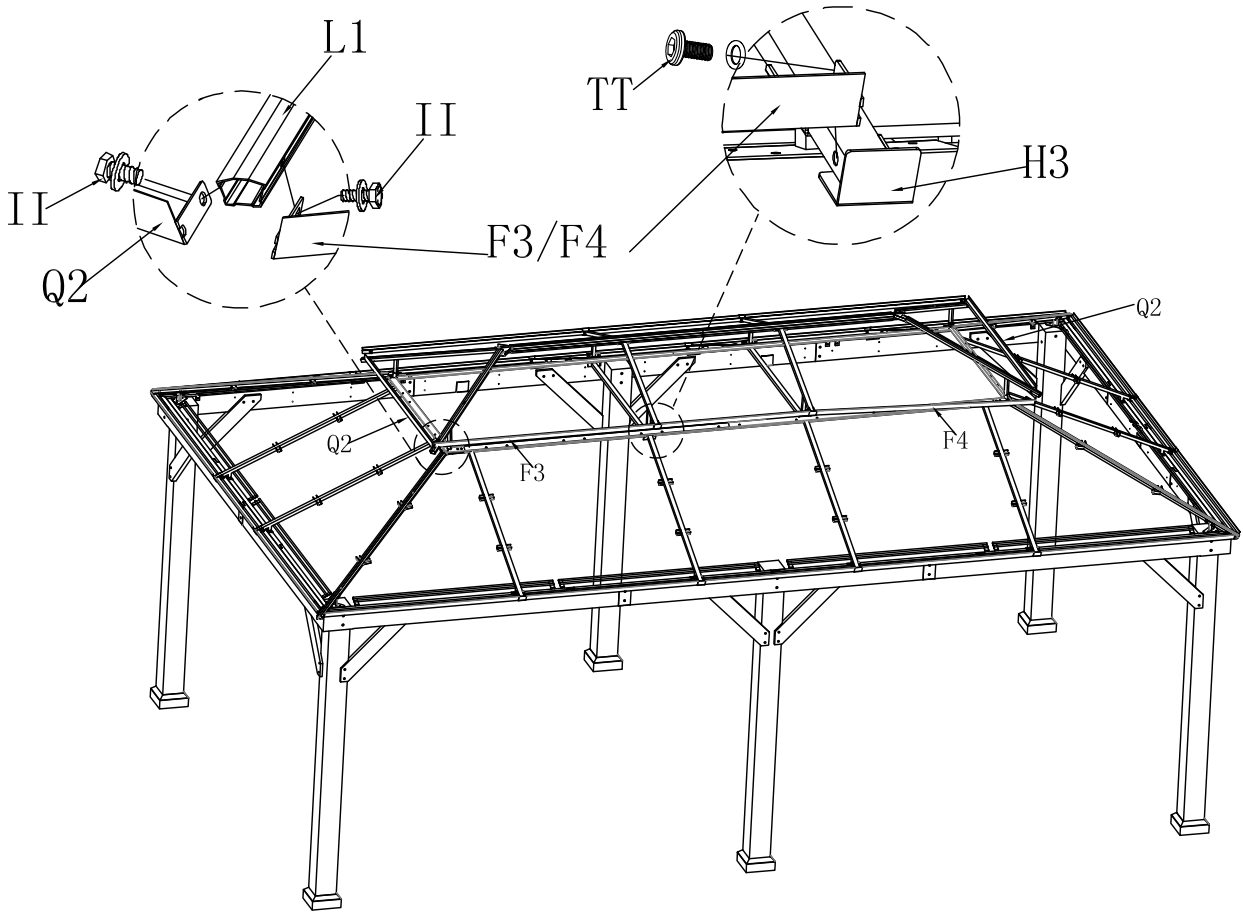

EN: Attach small roof short/long side blocking bars **Q2/F3** to small roof slant beam **L1** and small roof middle beams **H3** by using bolts **II** & screws **TT**.

FR: Fixer des barres de blocage latérales courtes/longues **Q2/F3** de petit toit à la poutre oblique **L1** de petite poutres de toit et moyennes **H3** de petit toit avec les boulons **II** et les vis **TT**.

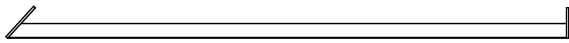

(F3) 2X

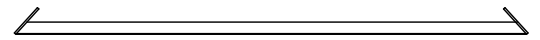

(Q2) 2X

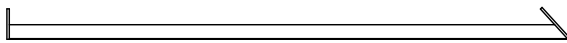

(F4) 2X

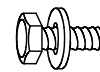

M6*15

(II) 8X



M6*15

(TT) 4X

<27>

EN: Attach small roof middle cover plates **T10** to small roof assembled frame.

Note: Insert upper end of middle cover plates **T10** into groove of small roof connector **J1**.

FR: Fixez les plaques de couverture centrale **T10** de petit toit à la charpente assemblée de petit toit.

Avis: Insérez l'extrémité supérieure des plaques de couverture centrale **T10** dans la rainure du connecteur **J1** du petit toit.

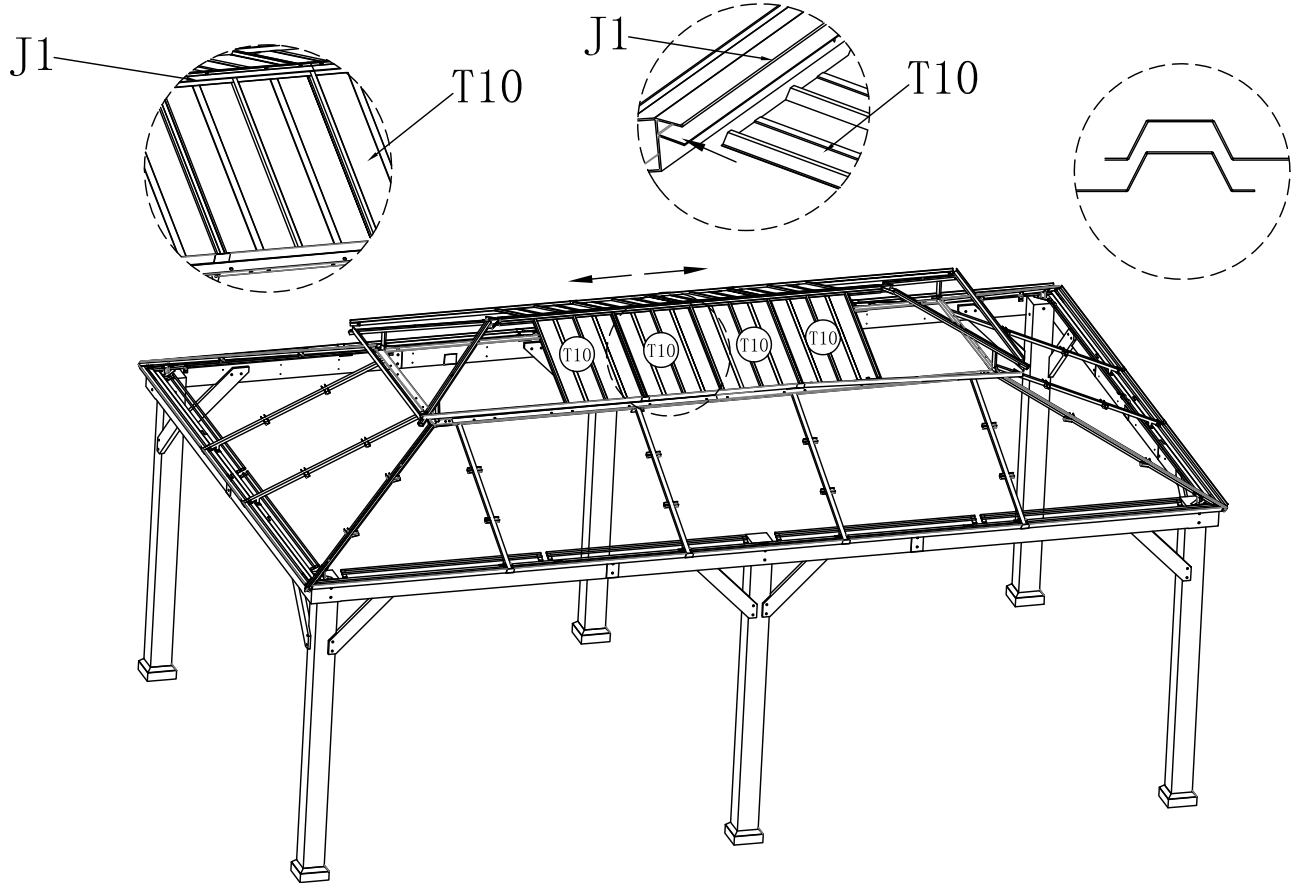

EN: note: Place the small roof cover plates from the middle position to both side.

FR: Avis: Placez la plaque de couverture du petit toit de la position centrale des deux côtés.

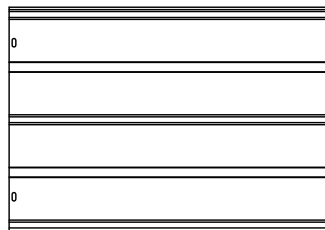

(T10) 8X

<28>

EN: Put the small roof left/right cover plates **T9/T11** of long side on small roof frame,insert upper end of the small roof left/right cover plates **T9/T11** into small roof connector **J1**.

FR: Placez les petites plaques de couverture gauche/droite **T9/T11** du toit de côté long sur une petite charpente de toit, Insérez l'extrémité supérieure des plaques de couverture gauche/droite **T9/T11** de petit toit dans le connecteur **J1** de petit toit.

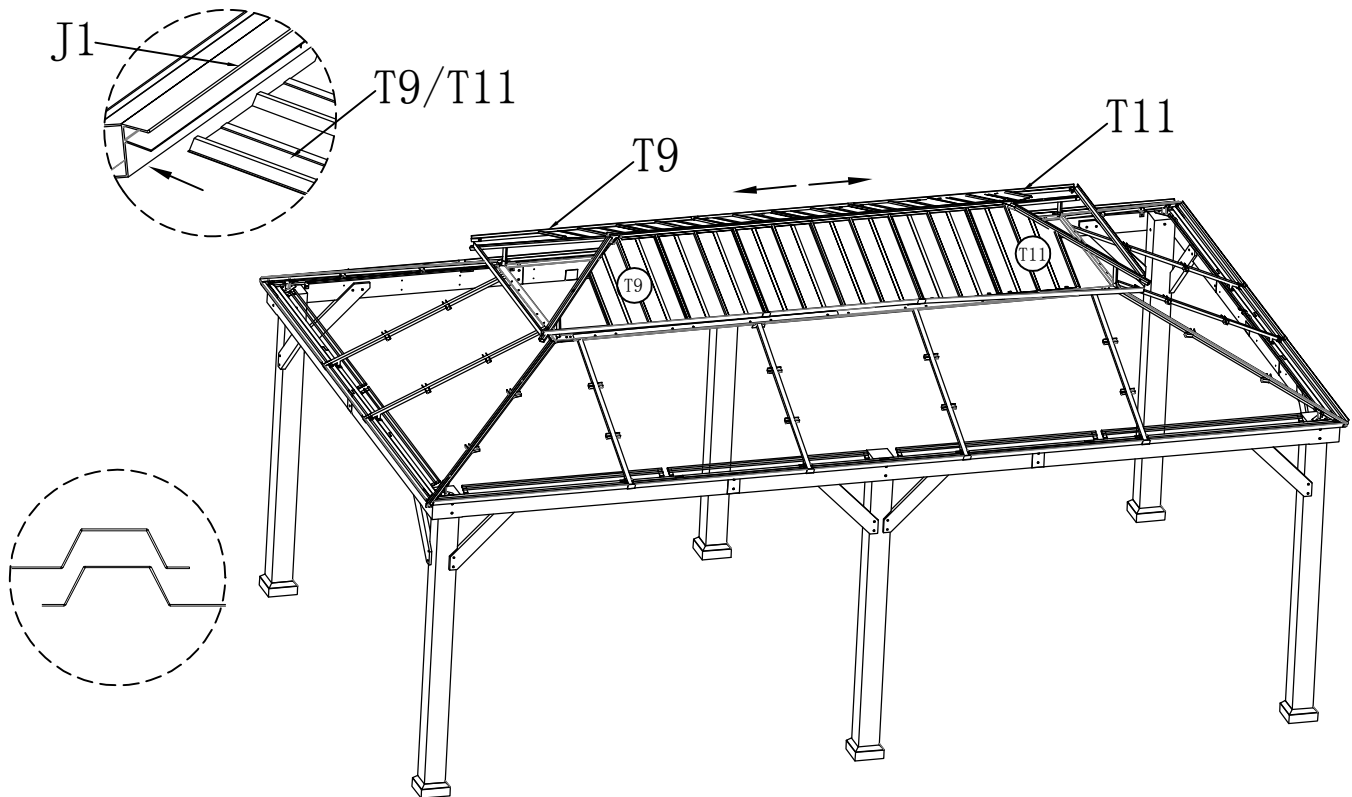

EN: Note: connection of cover plates are interlock.

FR: Avis:connexion de l'emboîtement de la plaque de recouvrement.

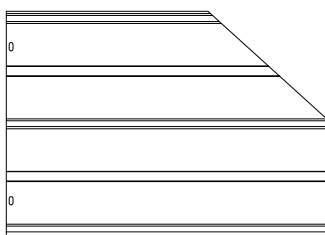

Ⓣ9 2X

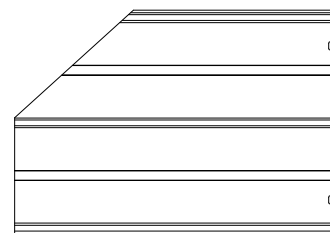

Ⓣ11 2X

<29>

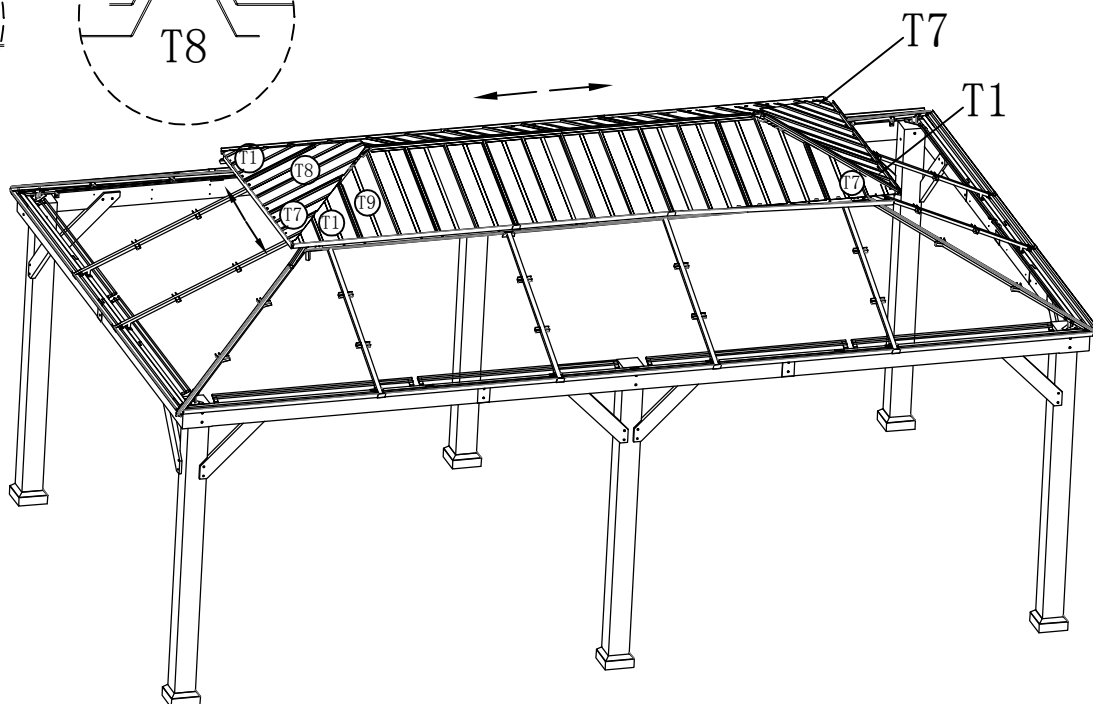
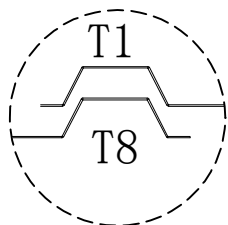
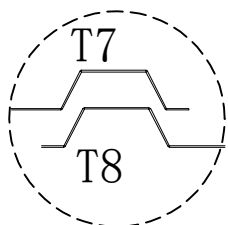

EN: Attach small roof left/right cover plate **T1/T7** to small roof assembled frame.
Note: connection of cover plates are interlock.

FR: Fixez la plaque de couverture gauche/droite **T1/T7** du petit toit à la charpente assemblée du petit toit.
Avis: connexion de l'emboîtement de la plaque de recouvrement.

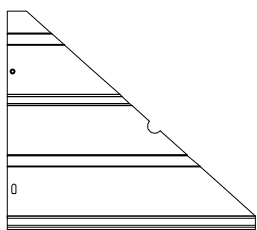

Ⓣ1 4X

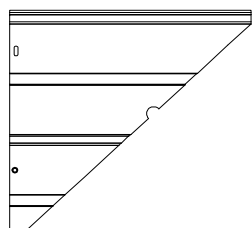

Ⓣ7 4X

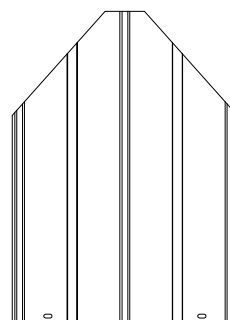

Ⓣ8 2X

<30>

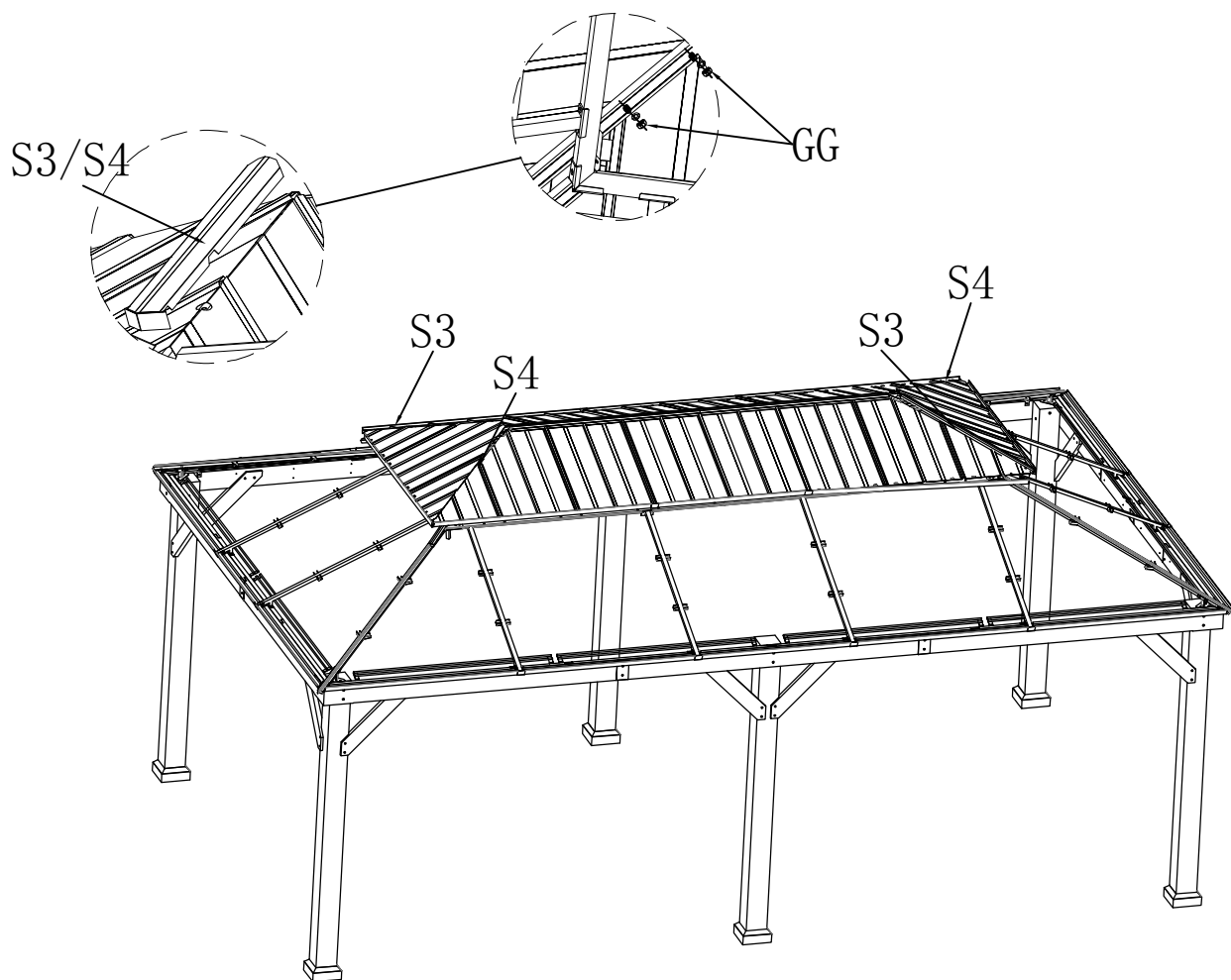

EN: Attach small roof slant cover **S3/S4** to small roof slant beam **L1**, fix inner side small roof slant beam **L1** by using nut **GG**.

FR: Fixer un petit couvercle incliné de toit **S3/S4** de petit toit à une petite poutre inclinée de toit **L1**, fixer la poutre inclinée latérale intérieure **L1** de petit toit avec des écrous **GG**.

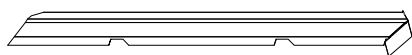

Ⓢ3 2X

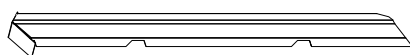

Ⓢ4 2X



ⒸGG 8X

<31>

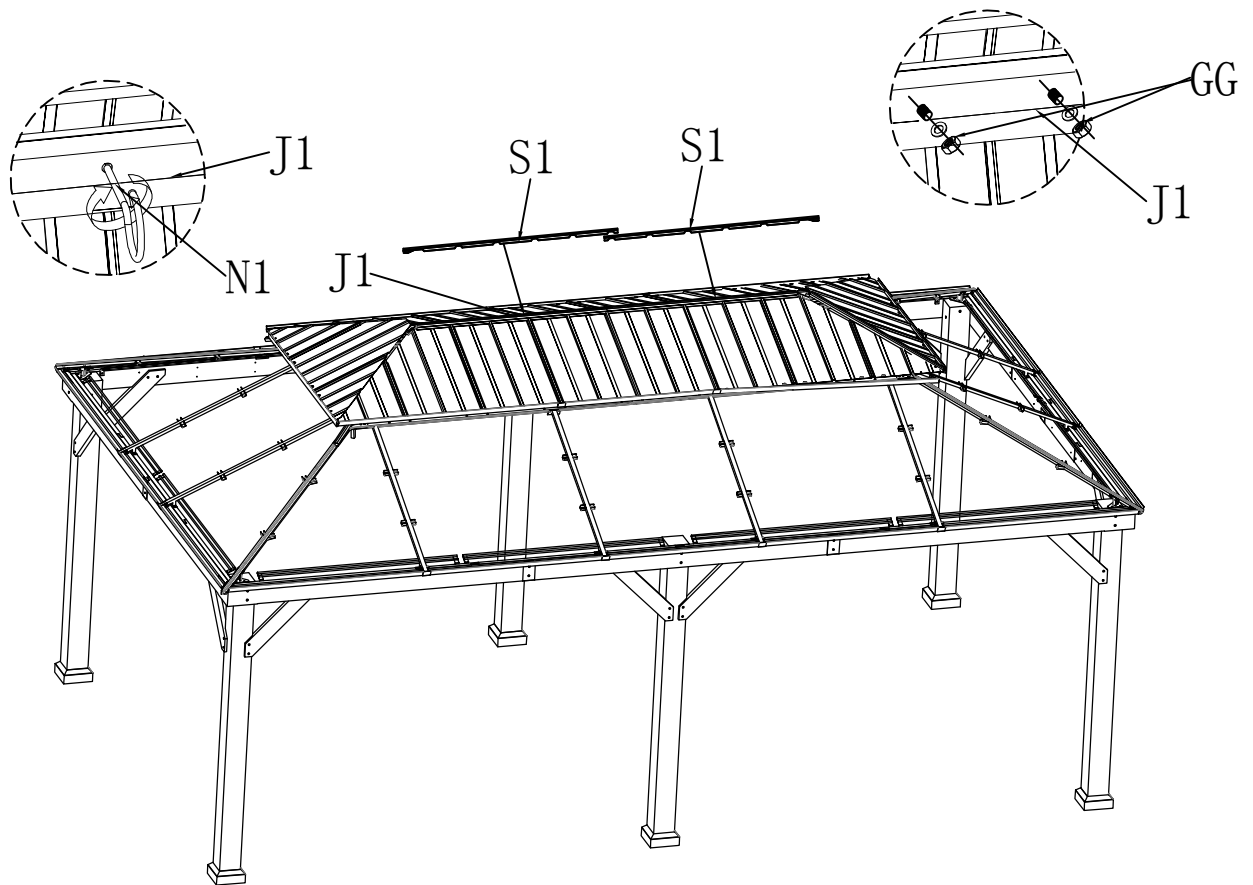

EN: Attach small roof cover **S1** to small roof connector **J1**, fix inner side small roof connector **J1** by using nuts **GG**, then attach Hook **N1** to small roof connector **J1**, turn hook to the right to tighten.

FR: Fixez le petit couvercle de toit **S1** au petit connecteur de toit **J1**, fixez le petit connecteur de toit **J1** du côté intérieur avec des écrous **GG**, puis fixez le crochet **N1** au petit connecteur de toit **J1**, tournez le crochet vers la droite pour serrer.

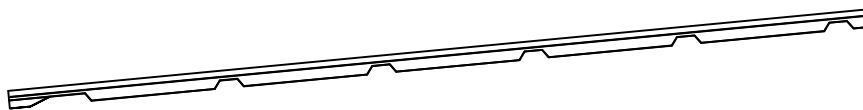

(S1) 2X

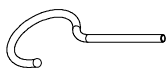

(N1) 2X



(GG) 4X

<32>

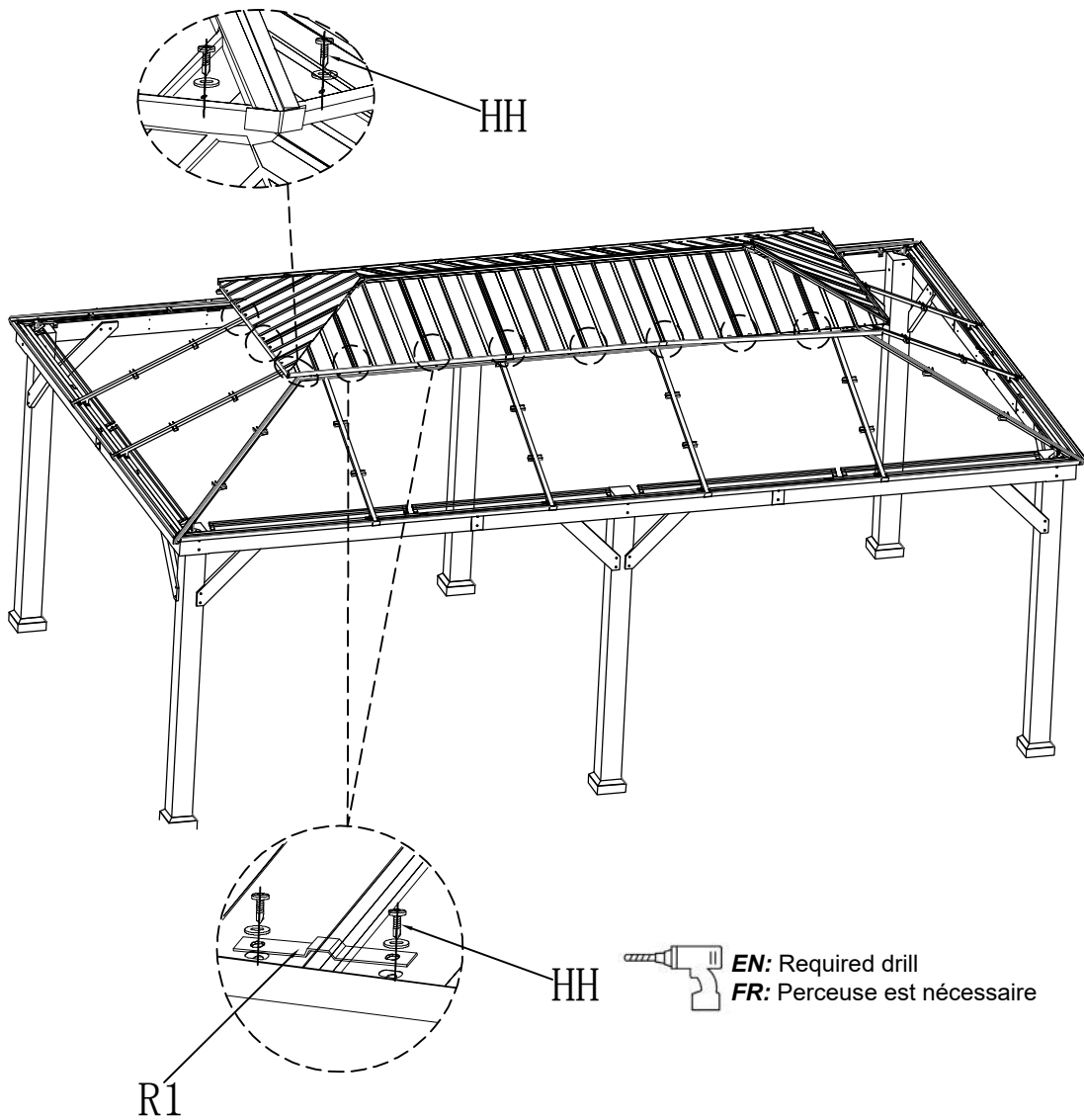

EN: Required drill
FR: Perceuse est nécessaire

EN: Attach the press panels **R1** to the all of the small cover plates and fix the the corners of the small roof cover plates by using screws **HH**. (Note:Please lock the screws after all small cover plates are put evenly.)

FR: Fixez les panneaux de presse **R1** à toutes les petites plaques de couverture et fixez les coins des petites plaques de couverture de toit avec les boulons **HH**.(Avis:Veuillez verrouiller les vis après que toutes les petites plaques de recouvrement ont été placées uniformément.)



(R1) 18X

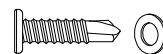

M6*15

(HH) 44X

<33>

EN: Insert two ends of middle across bar **K1/K2/K5** into groove of big roof beams **H1/H2**. Insert two ends of side lower across bars **K4** into groove of big roof beams **H1** and big roof slant beams **G1**. Insert two ends of side upper across bars **K3** into groove of big roof middle beams **H1** and big roof slant beams **G1**.

FR: Insérez deux extrémités du milieu à travers la barre **K1/K2/K5** dans la rainure des grandes poutres de toit **H1/H2**. Insérez deux extrémités latérales inférieures à travers les barres **K4** dans la rainure des grandes poutres de toit **H1** et des grandes poutres inclinées du toit **G1**. Insérez deux extrémités de la tige latérale à travers les barres **K3** dans la rainure des grandes poutres centrales **H1** du toit et des grandes poutres inclinées du toit **G1**.

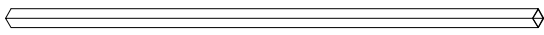
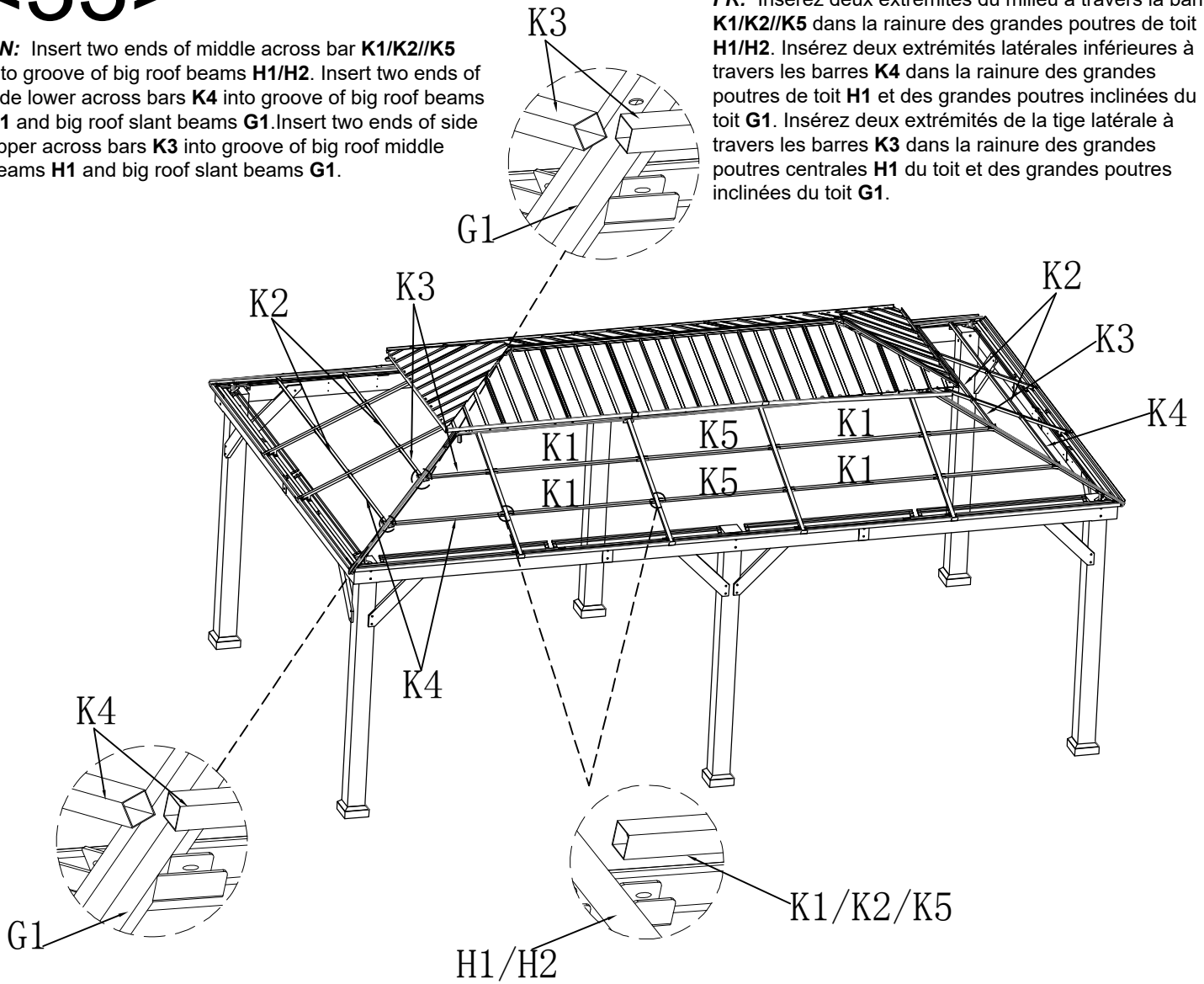

(K1) 8X

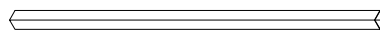

(K2) 4X

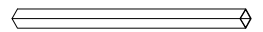

(K3) 8X



(K4) 8X

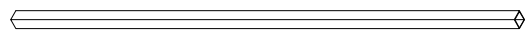

(K5) 4X

<34>

EN: Attach press panel **R1** to upper of big roof middle plates **T4** to assembled frame by using screws **TT**.

FR: Fixer les panneaux de presse **R1** à la partie supérieure des plaques de couverture centrale **T4** de grand toit au cadre assemblé avec les vis **TT**.

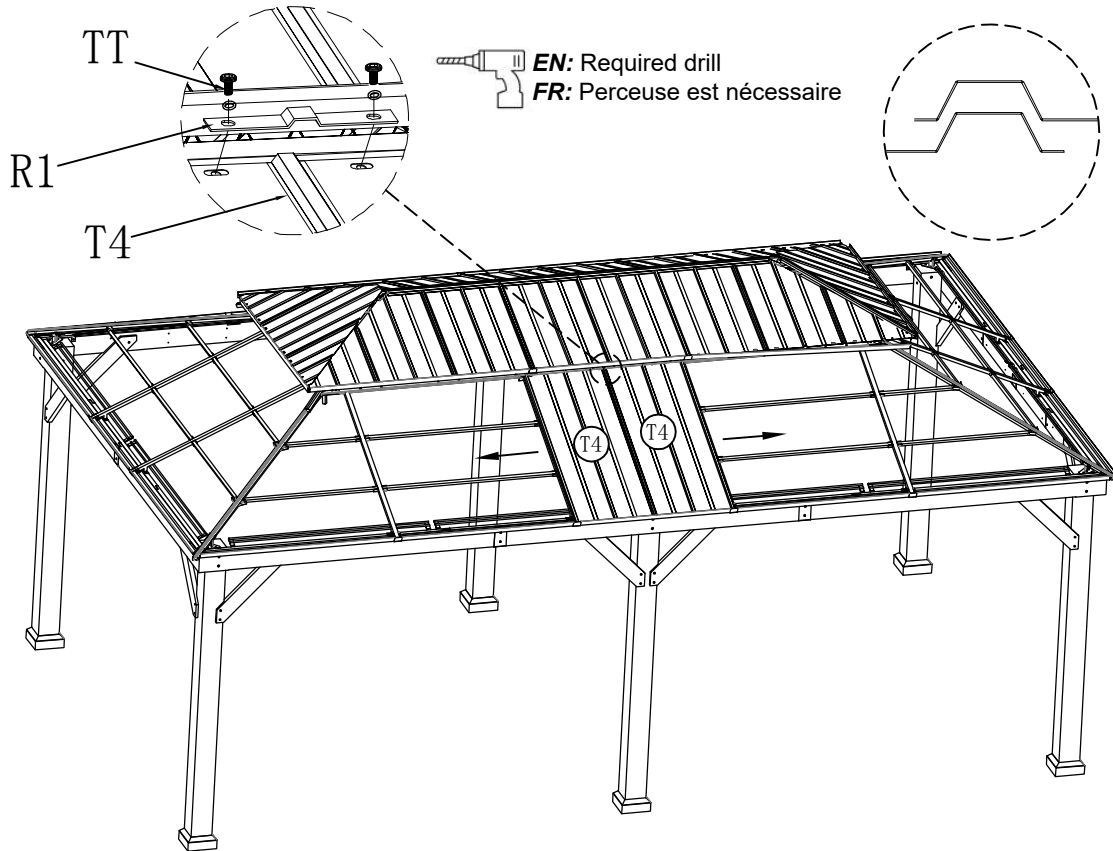

EN: Note: Place the long side cover plates **T4** from the middle position to both side. Please do not fully tighten screws **TT** prior to complete assembly for all small/big cover plates in Step 39.

FR: Avis: Placez les plaque de couverture **T4** de côté long de la position médiane vers les deux côtés. Veuillez ne pas serrer complètement les vis **TT** avant de terminer l'assemblage pour toutes les petites/grandes plaques de couverture à l'étape 39.

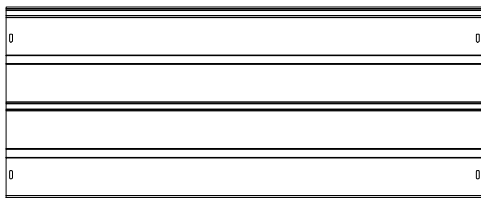

Ⓣ4 4X



Ⓡ1 2X



M6*15

Ⓣ1 4X

<35>

EN: Attach press panel **R1** to upper of big roof middle plates **T4** to assembled frame by using screws **TT**.

FR: Fixer les panneaux de presse **R1** à la partie supérieure des plaques de couverture centrale **T4** de grand toit au cadre assemblé avec les vis **TT**.

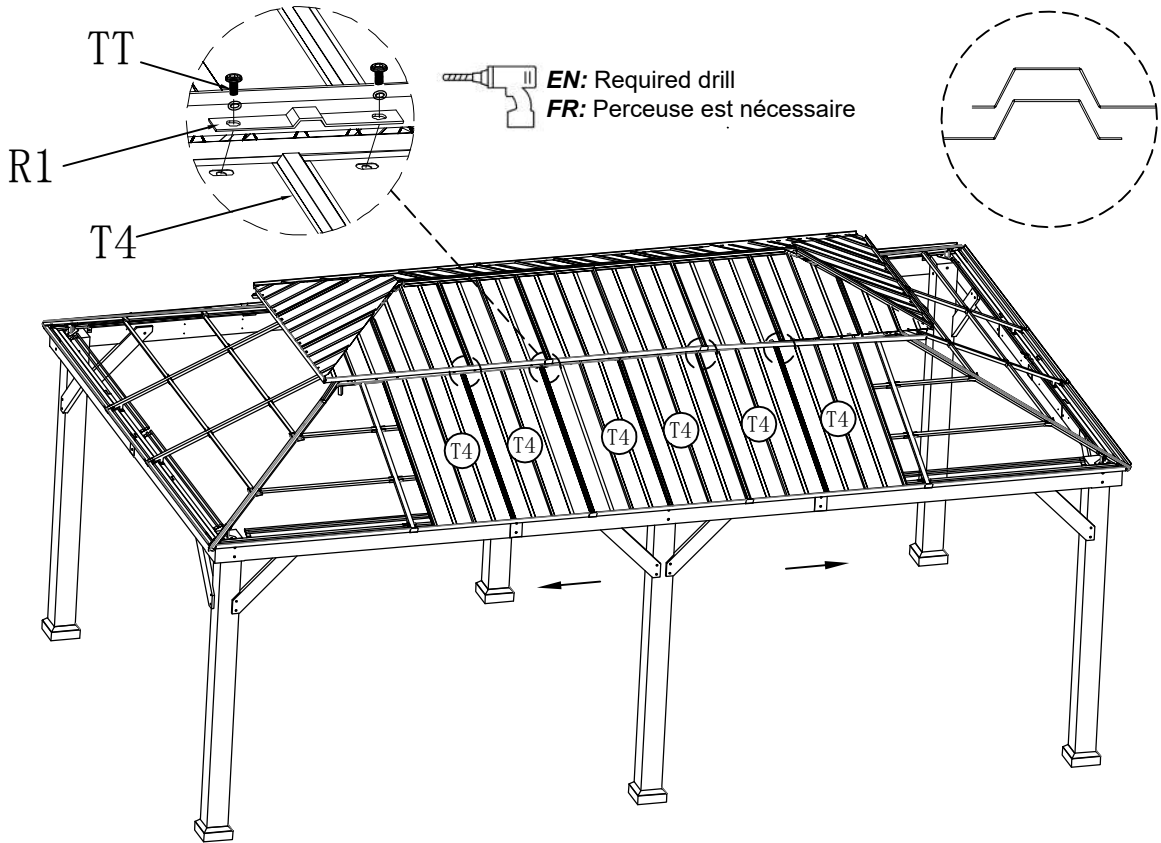

EN: Note: Place the long side cover plates **T4** from the middle position to both side. Please do not fully tighten screws **TT** prior to complete assembly for all small/big cover plates in Step 39.

FR: Avis: Placez les plaque de couverture **T4** de côté long de la position médiane aux deux côtés. Veuillez ne pas serrer complètement les vis **TT** avant de terminer l'assemblage pour toutes les petites/grandes plaques de couverture à l'étape 39.

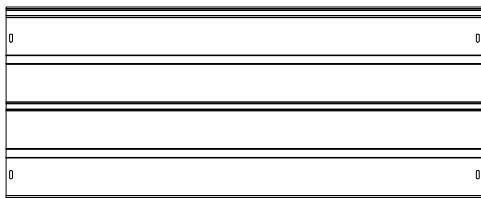

T4 8X



R1 8X



M6*15

TT 16X

<36>

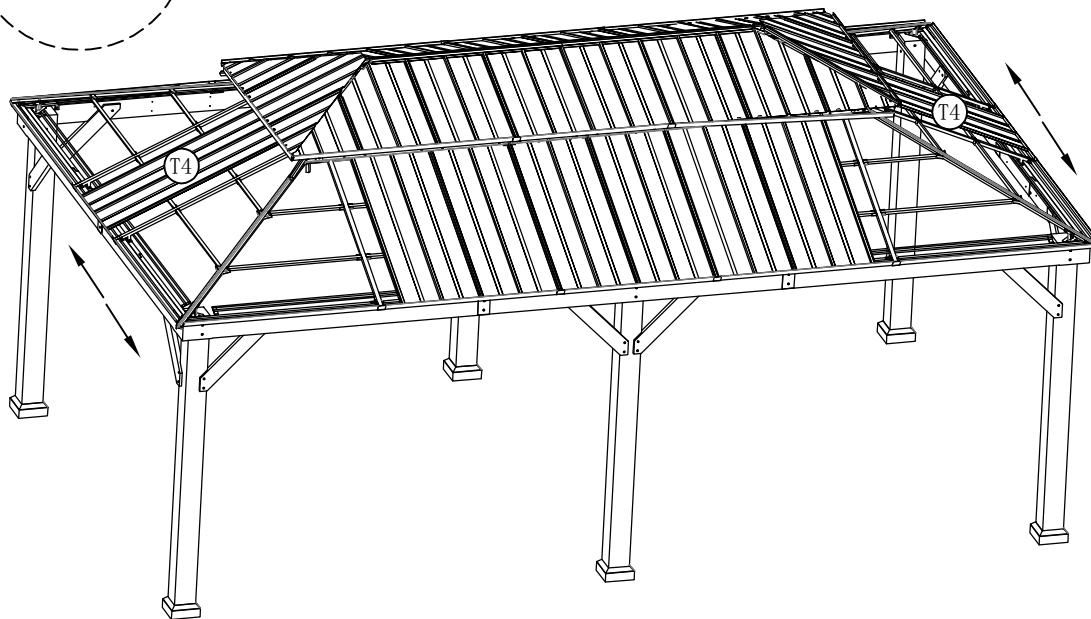
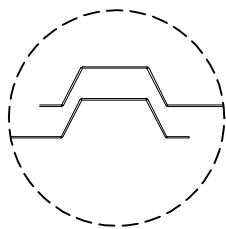

EN: Note: Place the short side cover plates **T4** from the middle position to both side.
(Note: connection of cover plates are interlock.)

FR: Avis: Placez les plaque de couverture **T4** de côté court de la position médiane aux deux côtés.
(Avis: connexion de l'emboîtement de la plaque de recouvrement.)

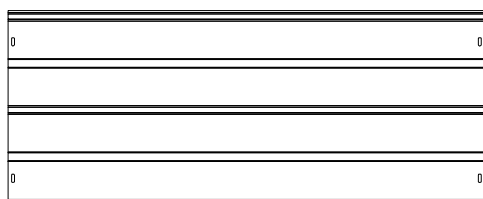

Ⓣ4 2X

<37>

 **EN:** Required drill
FR: Perceuse est nécessaire

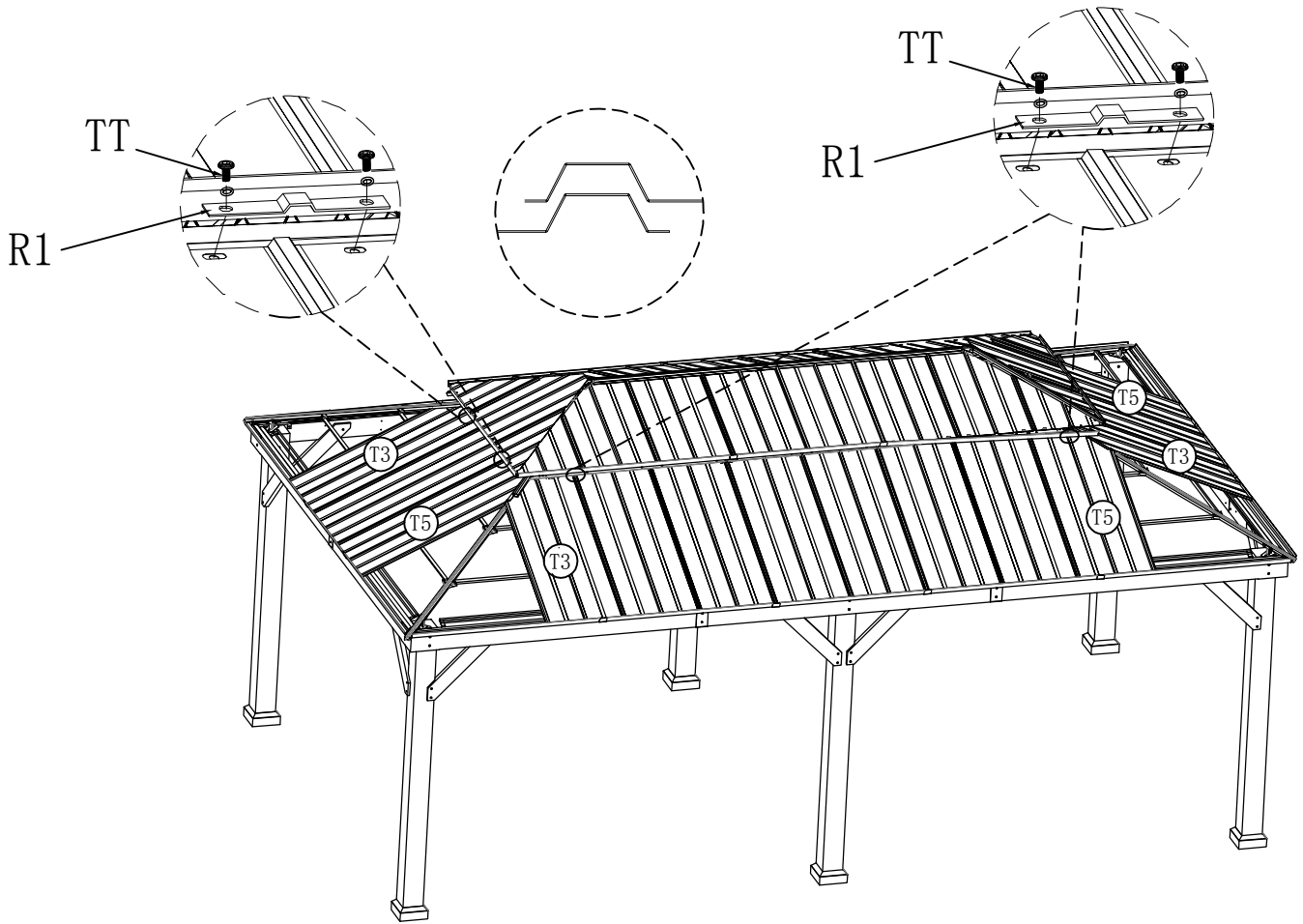

EN: Attach small press panel **R1** to upper of big roof left cover plates **T3**/right cover plates **T5** to assembled frame by using screws **TT**.

Note: Place the big roof cover plate from the middle position to both side. Please do not fully tighten screws **TT** prior to complete assembly for all small/big cover plates in Step 39.

FR: Fixez la petite presse **R1** à la partie supérieure des plaques de couverture gauche **T3**/plaques de couverture droite **T5** à la charpente assemblée de grand toit avec les vis **TT**.

Avis: Placez la plaque de couverture du grand toit de la position centrale des deux côtés. Veuillez ne pas serrer complètement les vis **TT** avant de terminer l'assemblage pour toutes les petites/grandes plaques de couverture à l'étape 39.

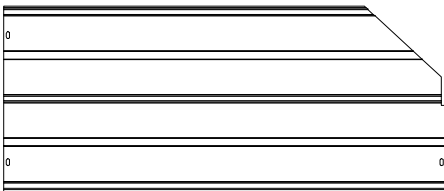

Ⓣ3 4X

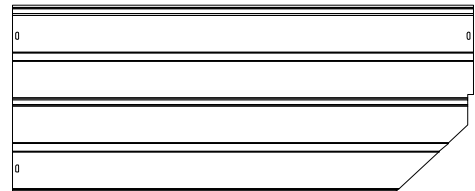

Ⓣ5 4X



Ⓡ1 8X



Ⓣ M6*15

ⓉⓉ 16X

<38>

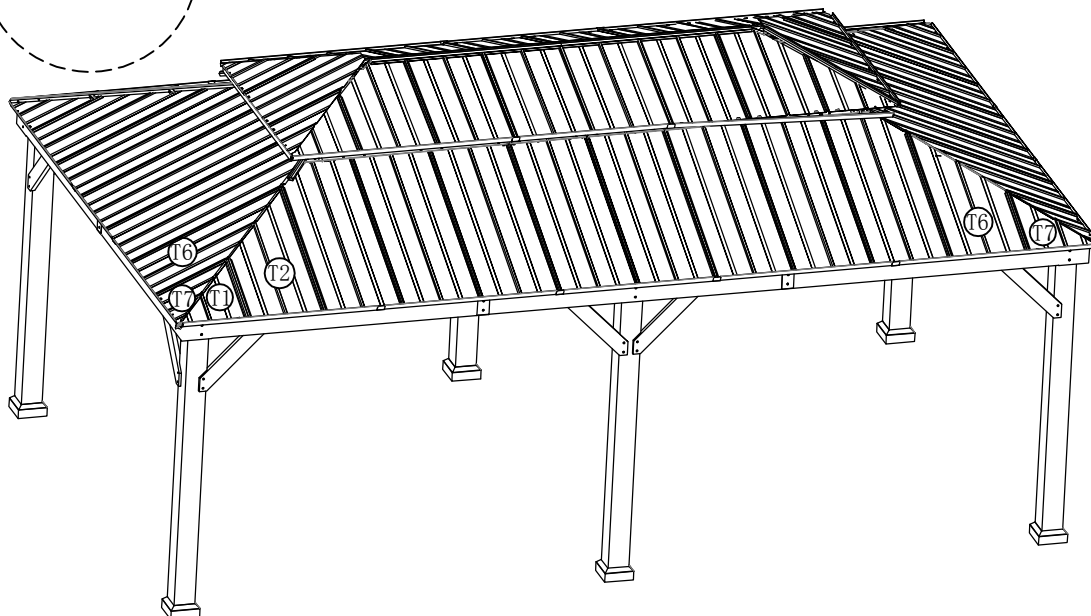
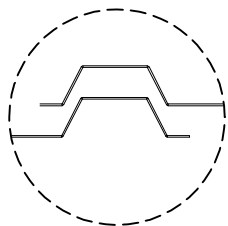

EN: Attach big roof right cover plates **T6/T7** and big roof left cover plate **T1/T2** to the big roof assembled frame.
Note: connection of cover plates are interlock.

FR: Fixer la plaque de couverture droite **T6/T7** de grand toit et la plaque de couverture gauche **T1/T2** de grand toit à la charpente assemblée de grand toit
Avis: connexion de l'emboîtement de la plaque de recouvrement.

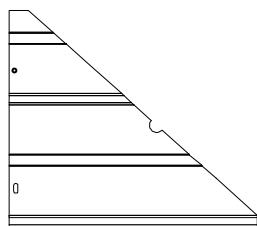

T1 4X

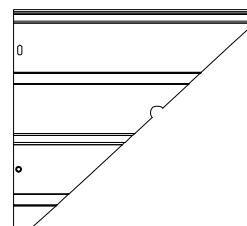

T7 4X

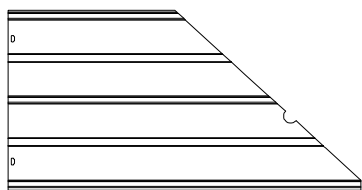

T2 4X

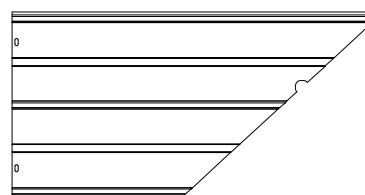

T6 4X

<39>

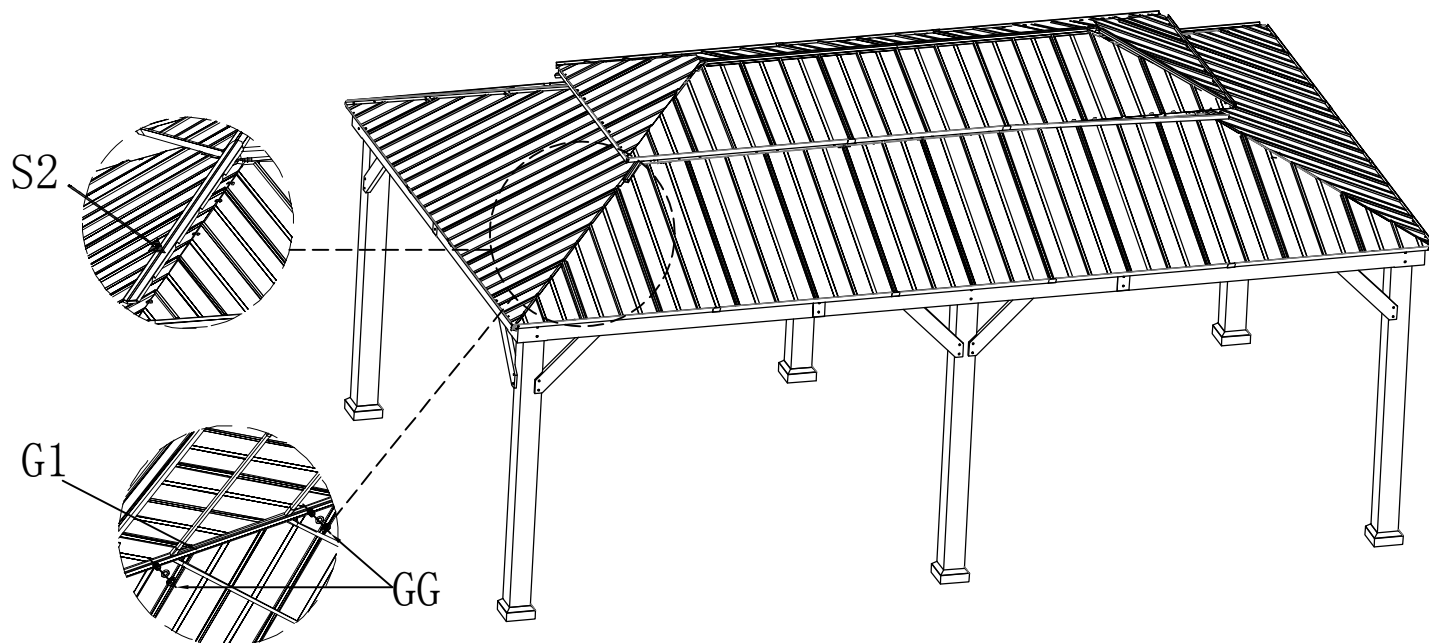

EN: Attach big roof long slant beam cover **S2** to big roof long slant beam **G1**, fix inner side of long slant beam **G1** by using nuts **GG**.

FR: Fixez le long couvercle de poutre oblique **S2** de grand toit à la poutre oblique longue **G1** de grand toit, fixez le côté intérieur de la poutre oblique longue **G1** avec des écrous **GG**.

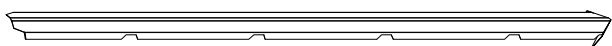

Ⓢ2 4X



ⓂGG 8X

<40>

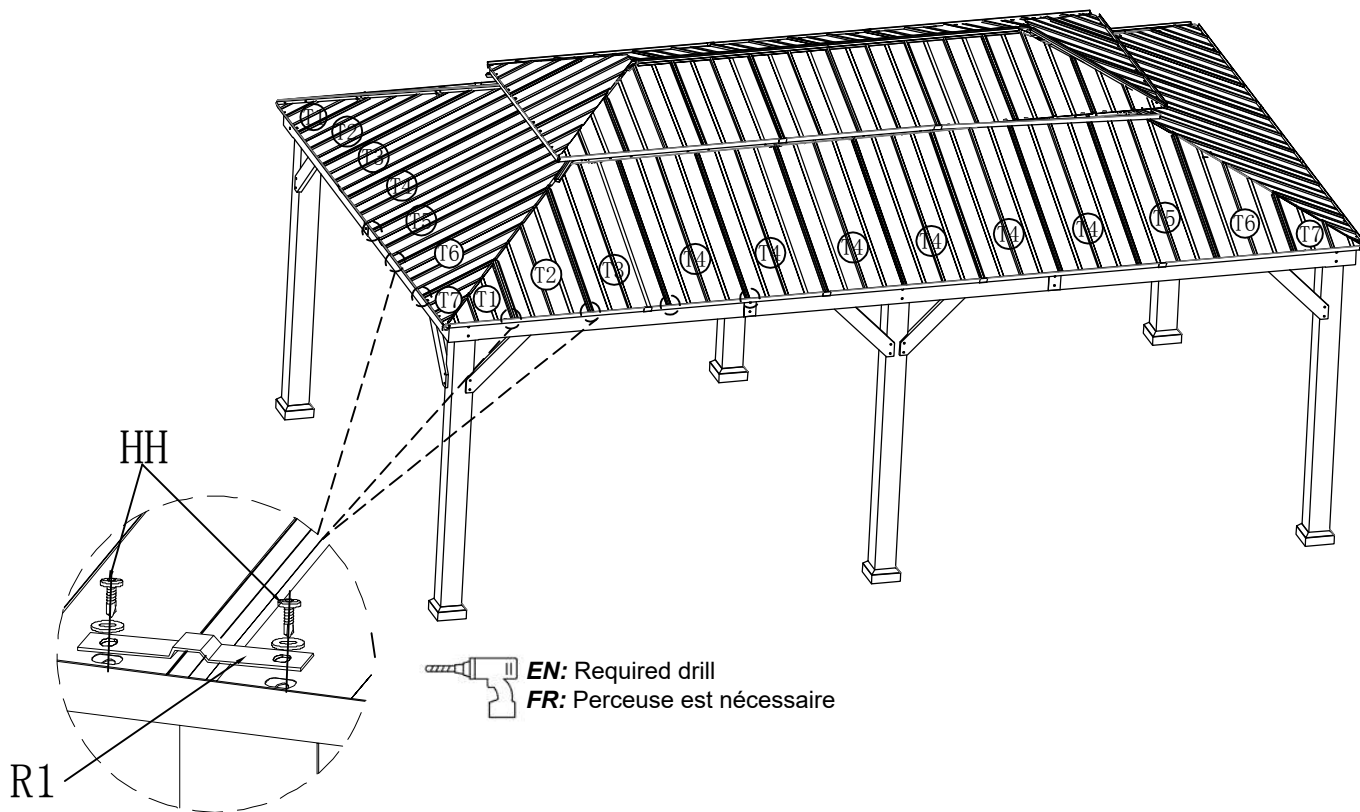

EN: Attach press panel **R1** to the bottom of cover plate to big roof assembled frame by using bolts **HH**.

FR: Fixez le panneau de presse **R1** au bas de la plaque de couverture à la charpente assemblée du grand toit avec les boulons **HH**.



(R1) 34X



(HH) 64X

<41>

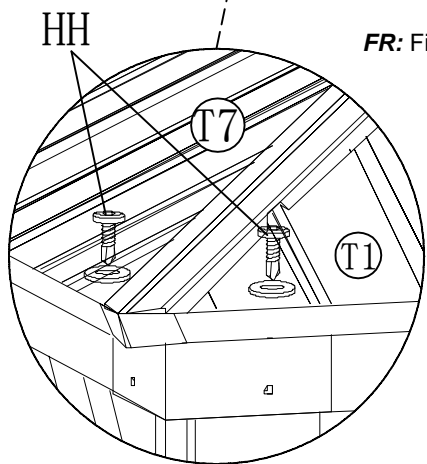
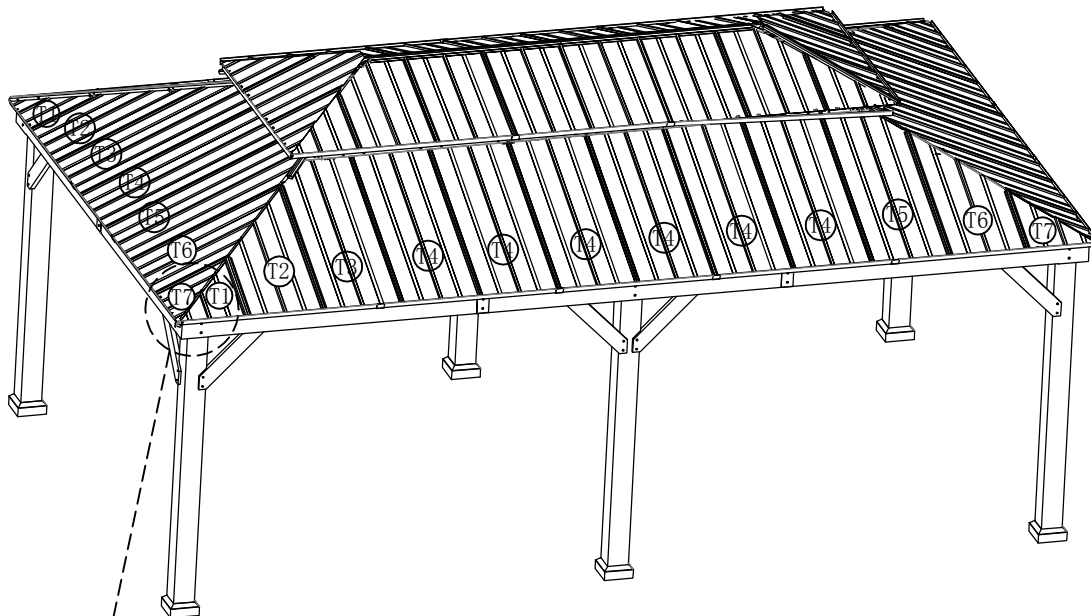

EN: Fix the corners of the big roof cover plates by using bolts **HH**.

FR: Fixez les coins des plaques de couverture du grand toit avec les boulons **HH**.



EN: Required drill

FR: Perceuse est nécessaire

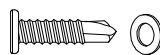

M6*15



8X

<42>

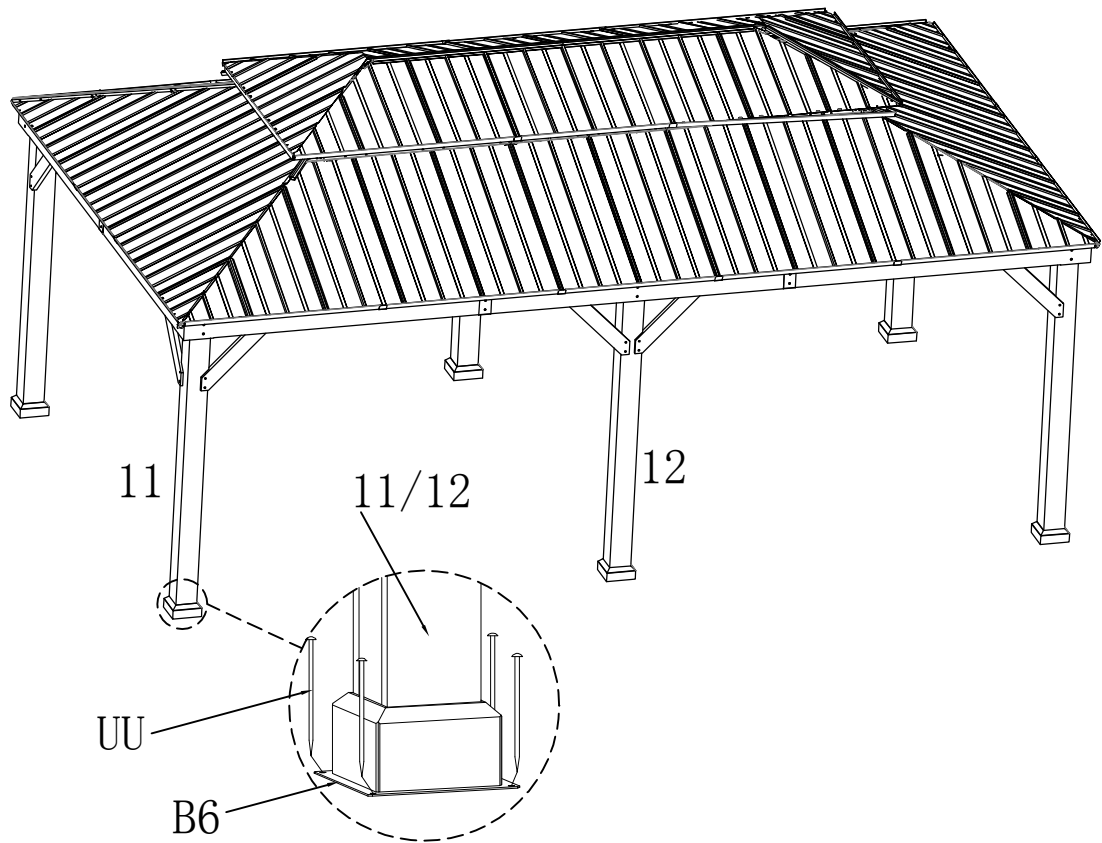

EN: Fix base **B6** of posts **11/12** on the ground by using stake **UU**.

FR: Fixez la base **B6** des poteaux **11/12** au sol en utilisant l'**UU** de piquet.

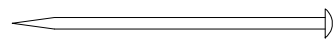

Ⓢ 24X

EN

Care and Maintenance

1. Our steel components for garden accessories and furniture are treated with rust inhibiting paint that protects it from rusting. However, due to the nature of steel, surface oxidation (rusting) will occur once these protective coatings are scratched. This is not a defect and thus not covered by the warranty.
2. To minimize this condition, we recommend care when assembling & handling the product to prevent scratching the paint. Should any scratching or damage occur, we recommend immediate touch-up with rust inhibiting paint.
3. Surface rust can also be easily removed with a very light application of common cooking oil. If surface oxidation (rusting) occurs and if no measure is taken to prevent this, the oxidation may start dripping on to deck or patio and caused damaging stains, which may be difficult to remove. This can be prevented if the above-mentioned measures are taken to keep the product from oxidizing.
4. Use damp cloth to wipe off the stains as quickly as possible.
5. If necessary, wash with a mild solution of soap and water; rinse thoroughly and dry completely.
6. Periodically check and ensure that all bolts are well-tighten during use.

FR:

Maintenance préventive et corrective

1. Les composants en acier des meubles et accessoires de jardin sont traités avec une peinture antirouille pour les protéger de la rouille. Cependant, en raison de la nature de l'acier, une oxydation de surface (rouille) se produira une fois ces revêtements protecteurs rayés. Ce qui n'est pas un défaut et n'est donc pas couvert par la garantie.
2. Afin de minimiser l'occurrence de cette situation, nous vous recommandons de veiller lors de l'assemblage et de la manipulation du produit à éviter de rayures sur la peinture. En cas de rayures ou de dommages, il est recommandé de les réparer immédiatement par une peinture antirouille.
3. La rouille de surface sera également facilement éliminée avec une très légère application d'huile de cuisson courante. Si une oxydation de surface (rouille) se produit et qu'aucune mesure n'est prise, l'oxydation peut commencer à s'égoutter sur la terrasse ou le patio, provoquant des taches dommageables qui seront difficiles à enlever. Les mesures mentionnées ci-dessus sont pour éviter l'oxydation du produit.
4. Nettoyez les taches dès que possible avec un chiffon humide.
5. Si nécessaire, lavez-le avec une solution d'eau et de savon doux, puis le rincez et séchez complètement.
6. Vérifiez périodiquement et assurez-vous que tous les boulons sont serrés pendant l'utilisation.