

3-Person Patio Porch Swing

Assembly Instructions

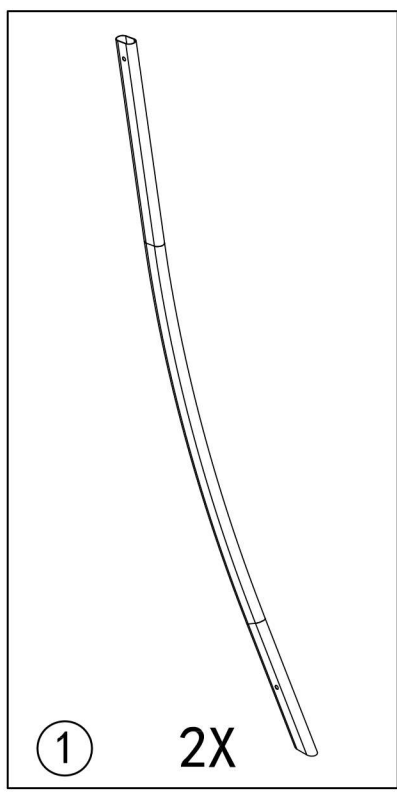
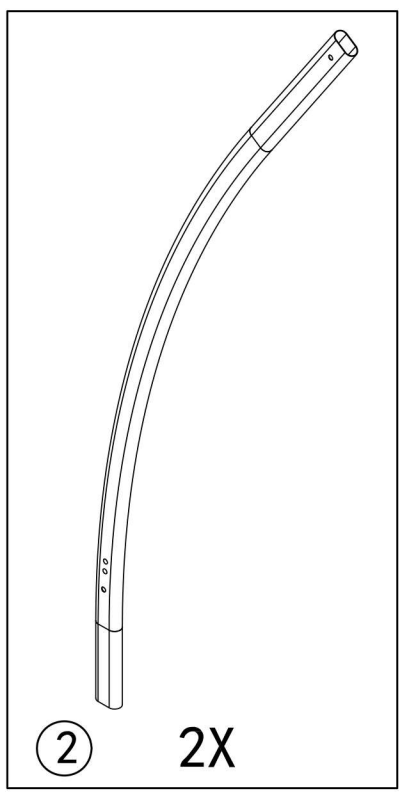
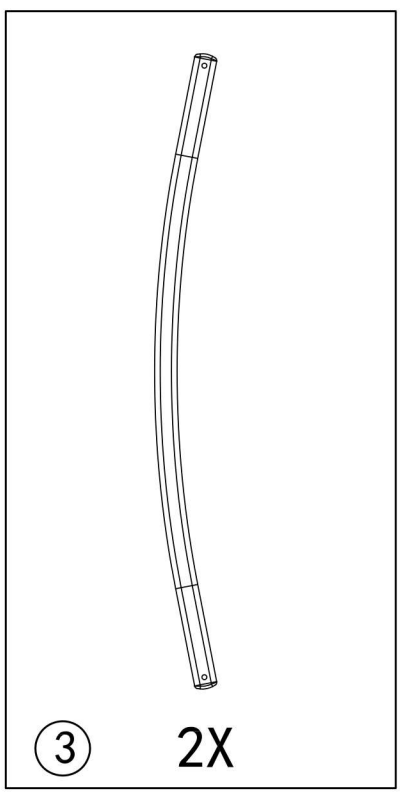
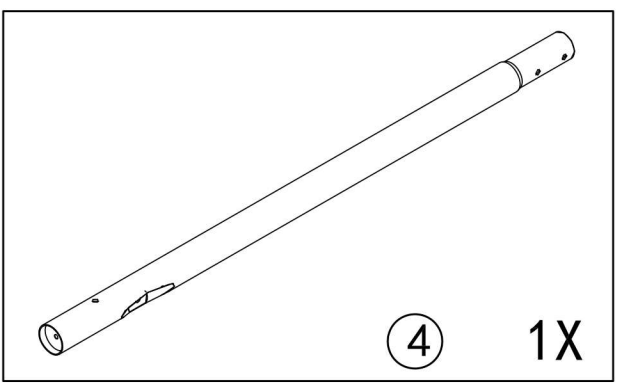
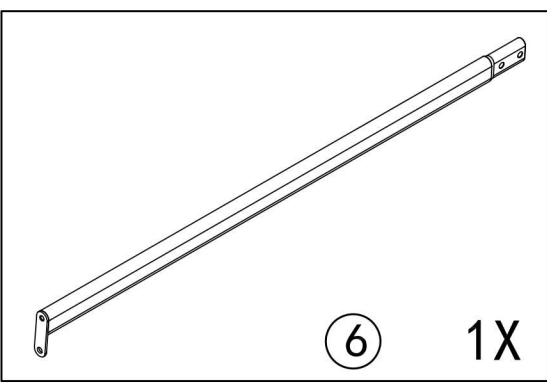
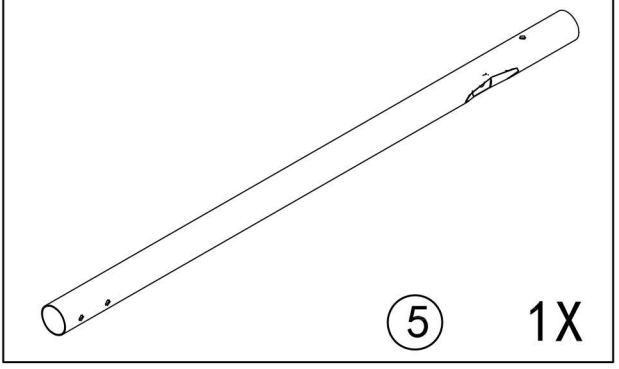
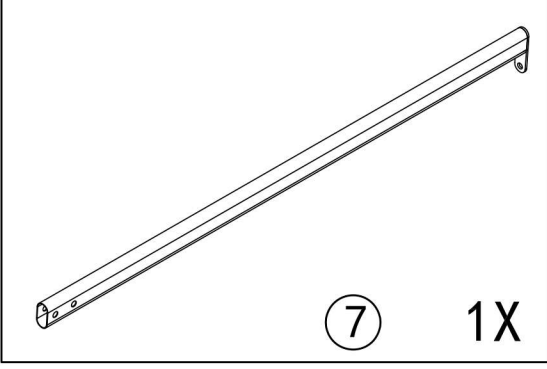
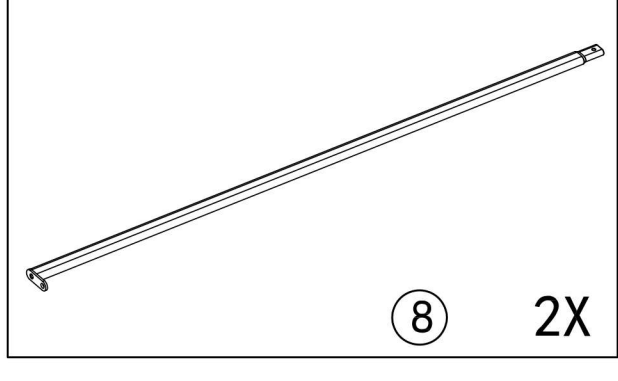
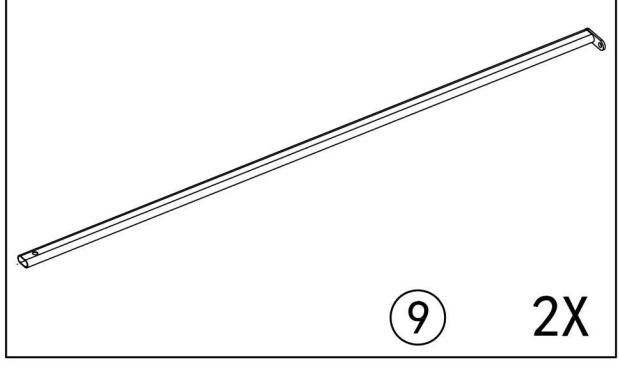
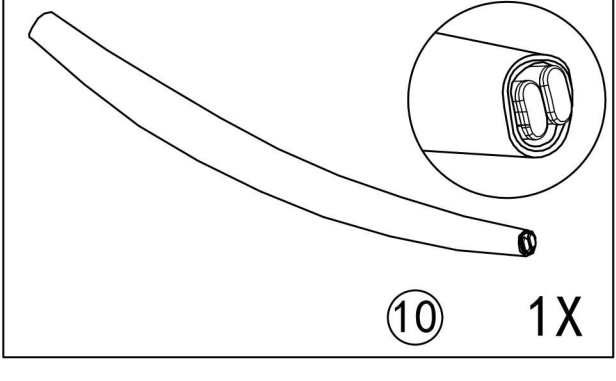
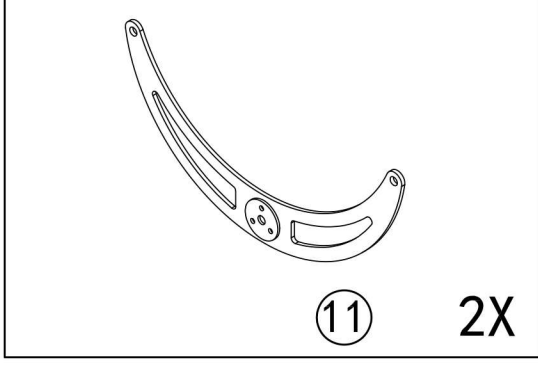
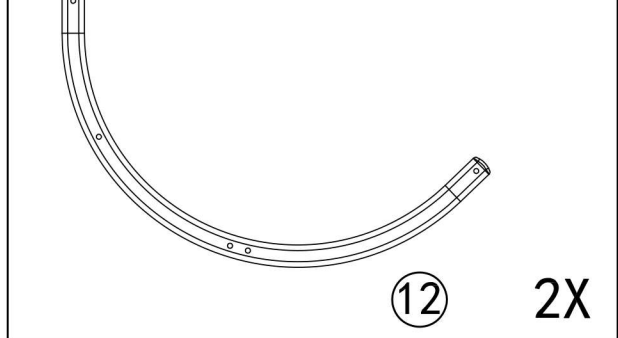
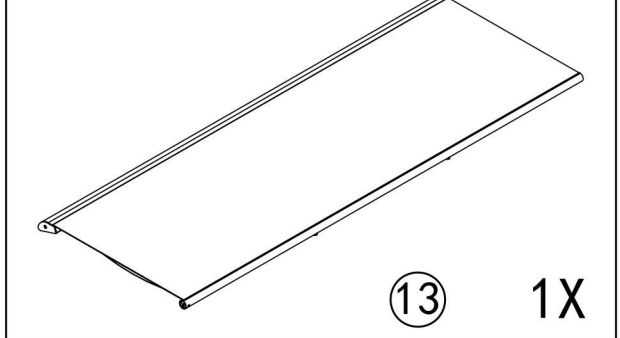
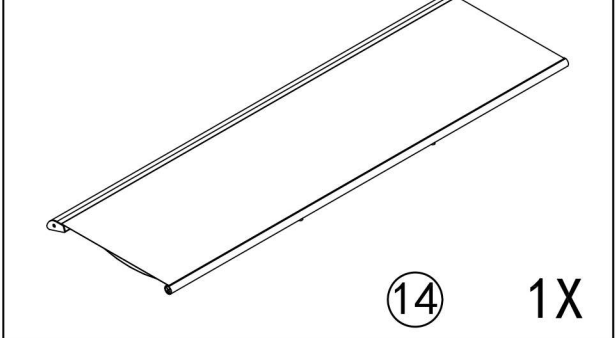
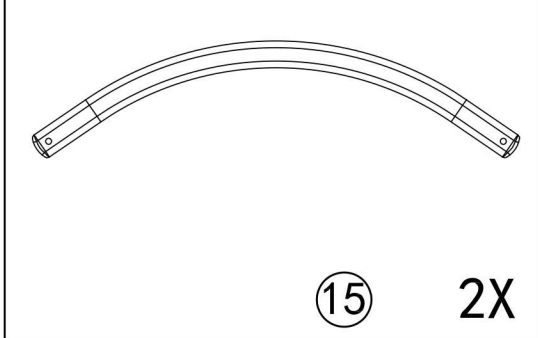
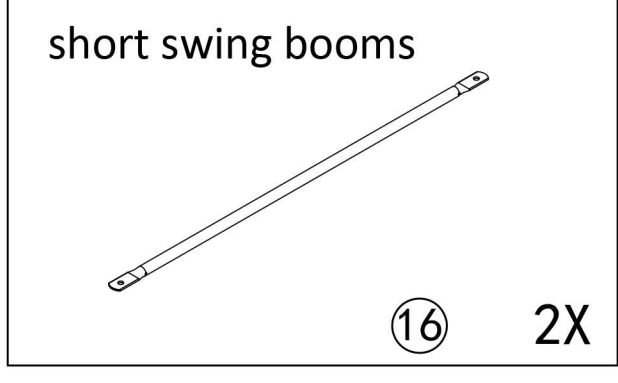
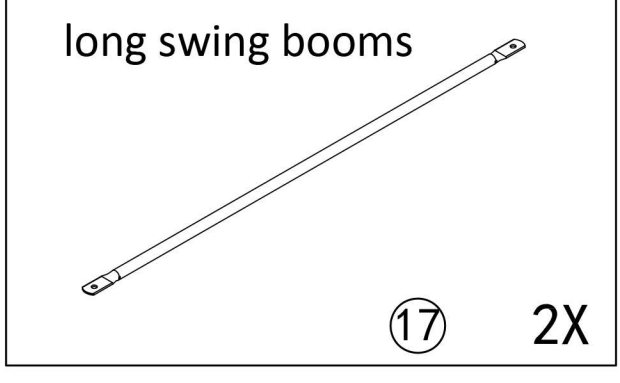
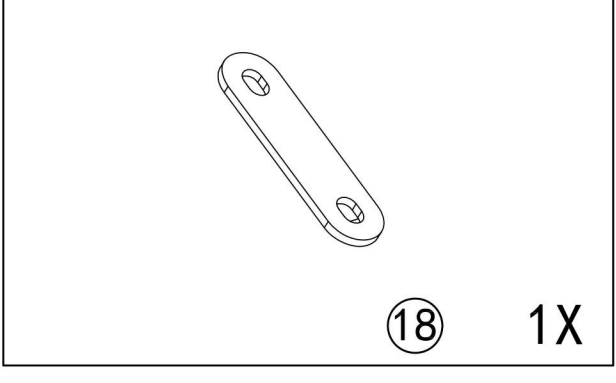
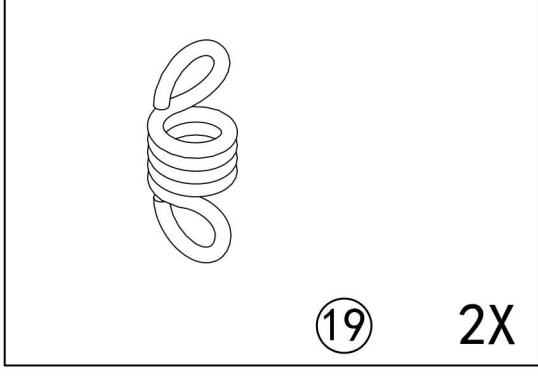
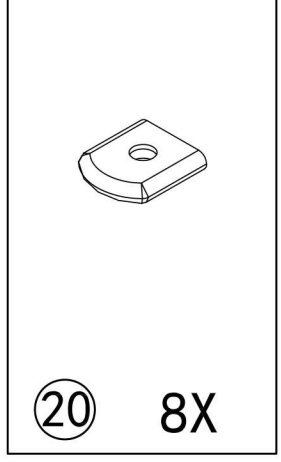
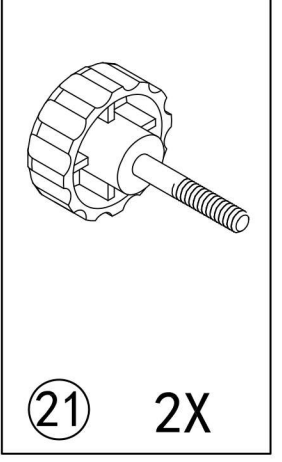
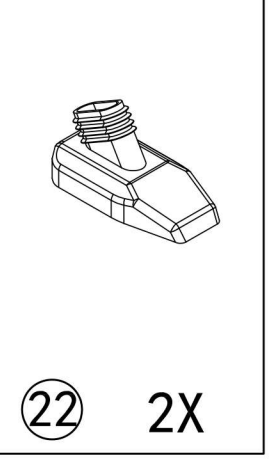
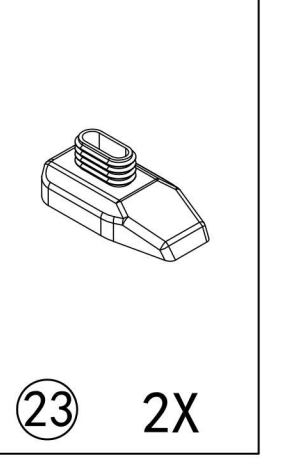
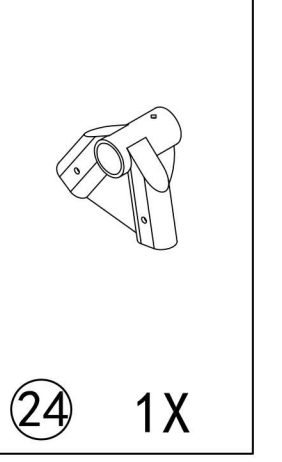
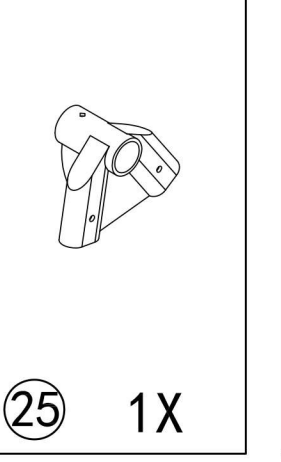
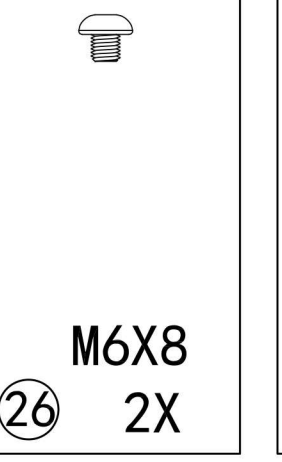
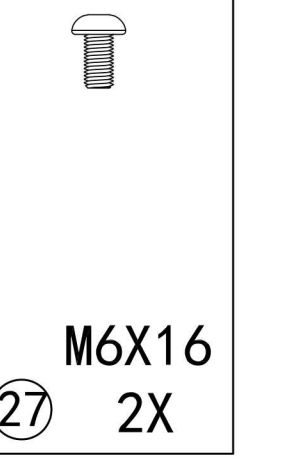
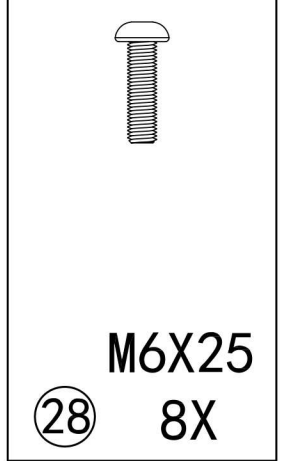
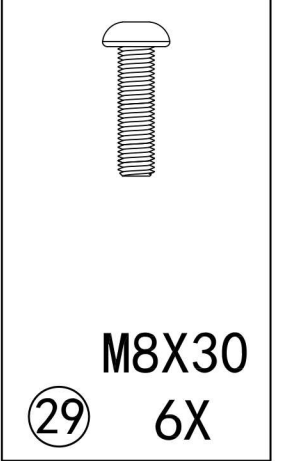
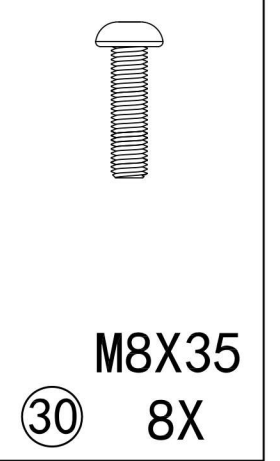
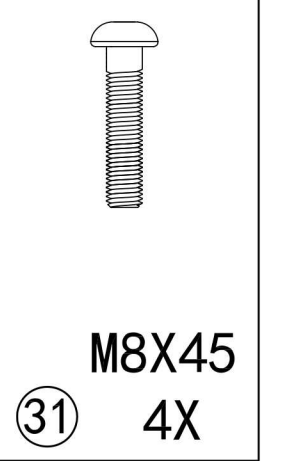
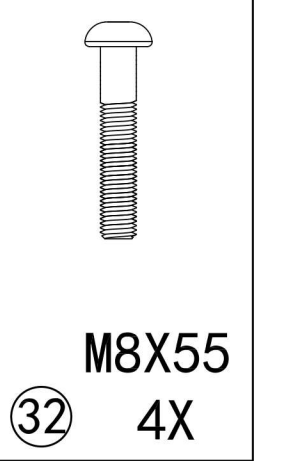
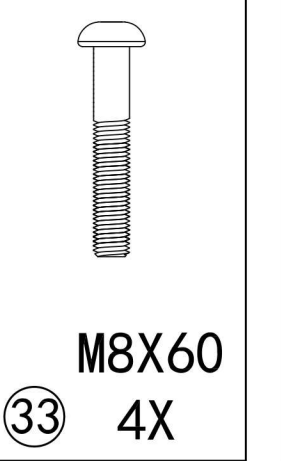
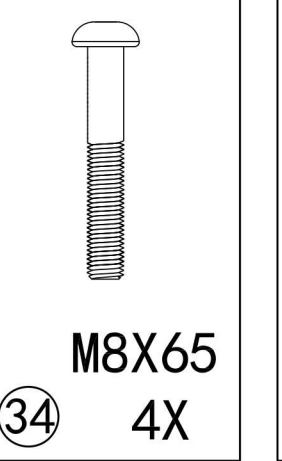
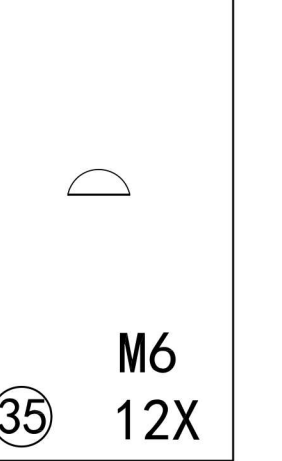
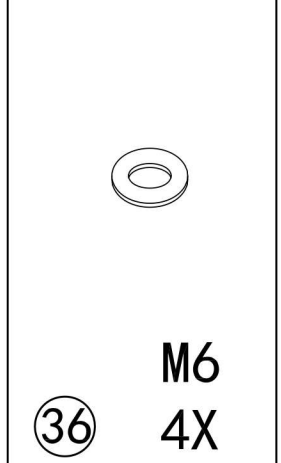
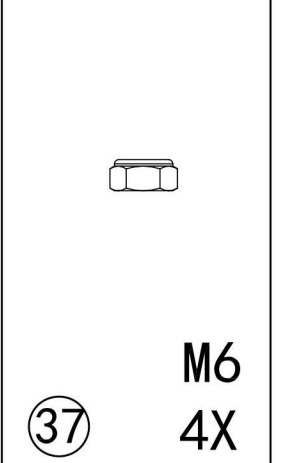
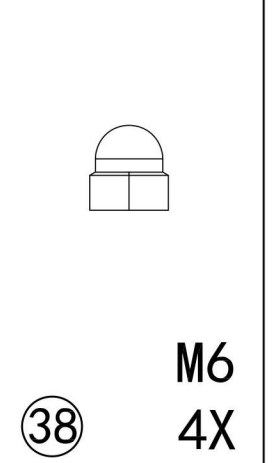
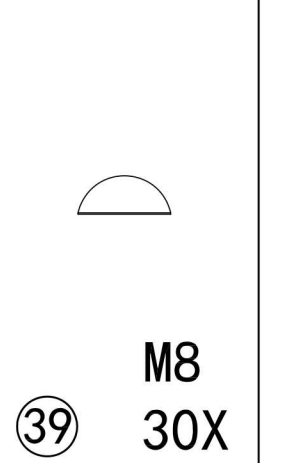
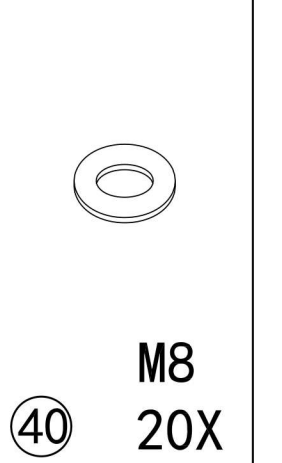
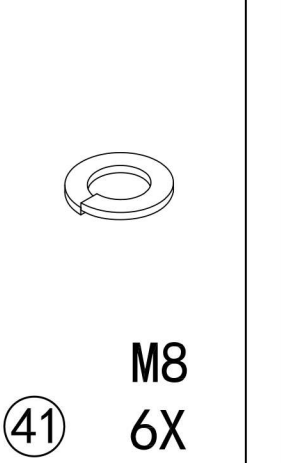
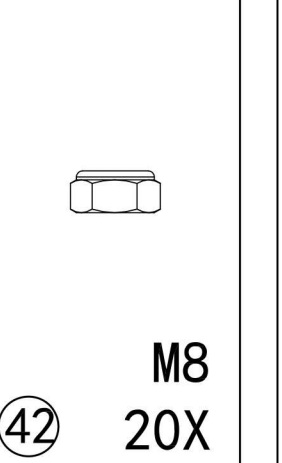
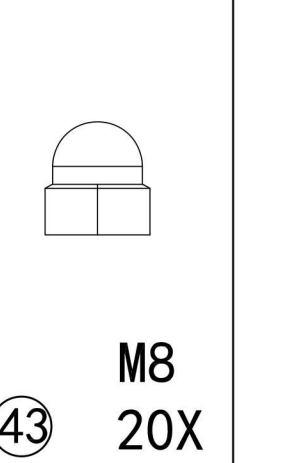
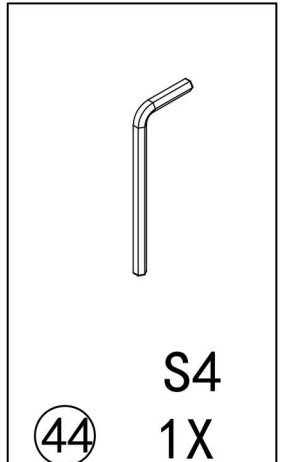
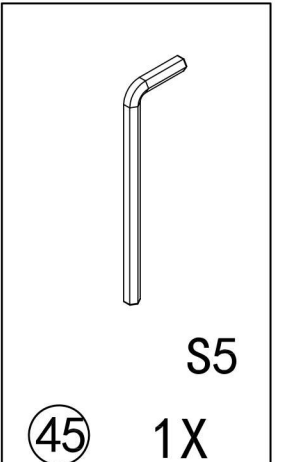
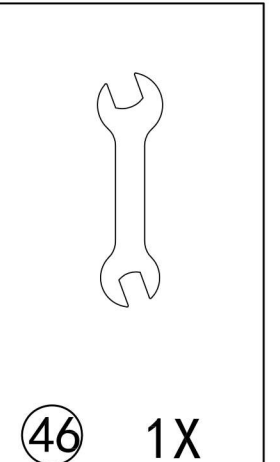

Please ensure all parts listed included before assembly and feel free to contact us if there are any problems.

				
① 2X	② 2X	③ 2X	④ 1X	⑥ 1X
				
⑤ 1X	⑦ 1X	⑧ 2X	⑨ 2X	⑩ 1X
				
⑪ 2X	⑫ 2X	⑬ 1X	⑭ 1X	⑮ 2X
				
short swing booms ⑯ 2X	long swing booms ⑰ 2X	⑱ 1X	⑲ 2X	
				
⑳ 8X	㉑ 2X	㉒ 2X	㉓ 2X	㉔ 1X
				
㉕ 1X	M6X8 ㉖ 2X	M6X16 ㉗ 2X		
				
M6X25 ㉘ 8X	M8X30 ㉙ 6X	M8X35 ㉚ 8X	M8X45 ㉛ 4X	M8X55 ㉜ 4X
				
M8X60 ㉝ 4X	M8X65 ㉞ 4X	M6 ㉟ 12X		
				
M6 ㉞ 4X	M6 ㉟ 4X	M6 ㊱ 4X	M8 ㊲ 30X	M8 ㊳ 20X
				
M8 ㊴ 6X	M8 ㊵ 20X	M8 ㊶ 20X		
				
S4 ㊷ 1X	S5 ㊸ 1X	㊹ 1X		

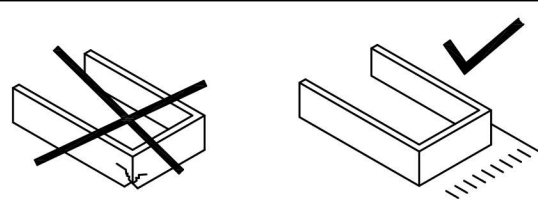

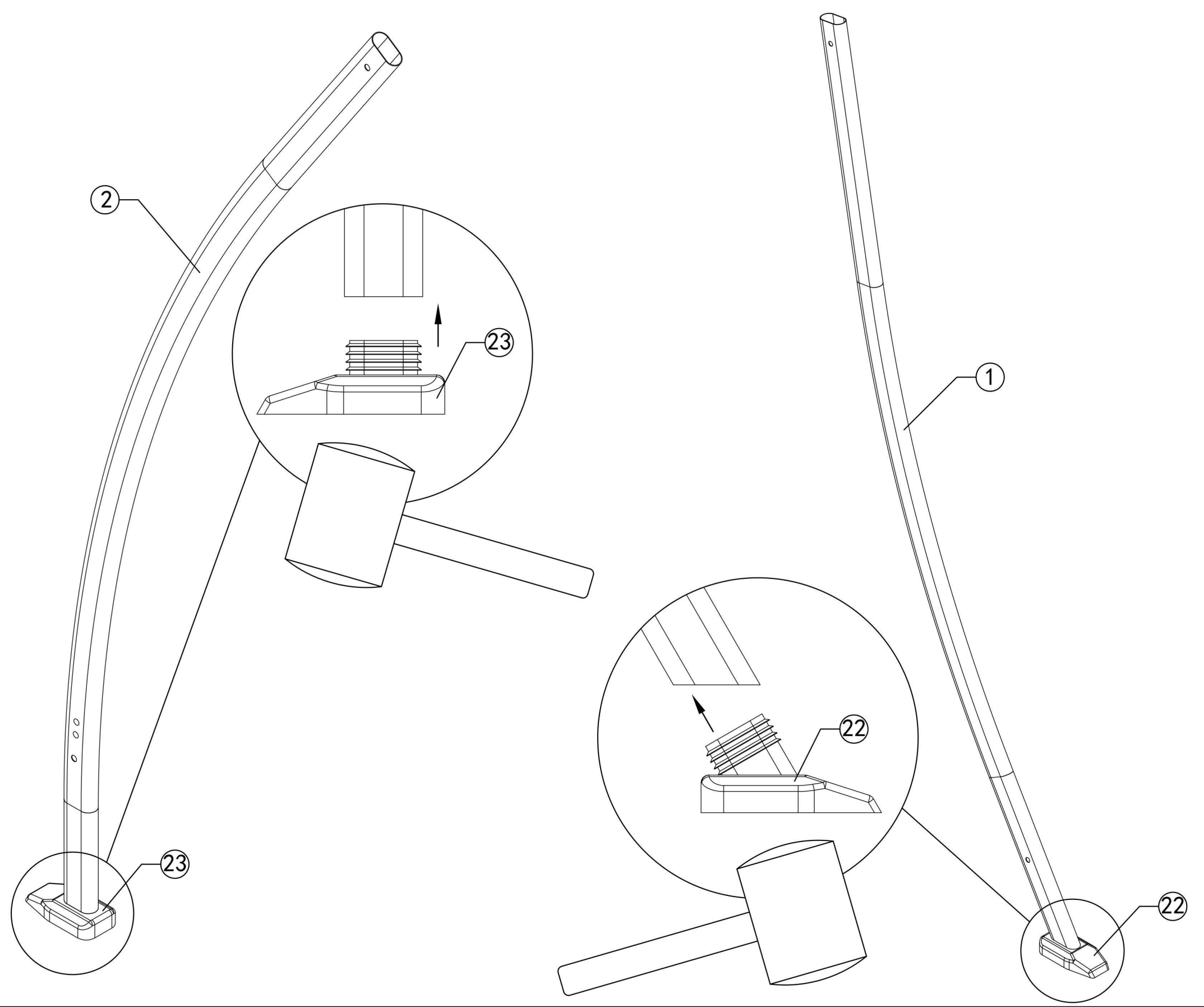
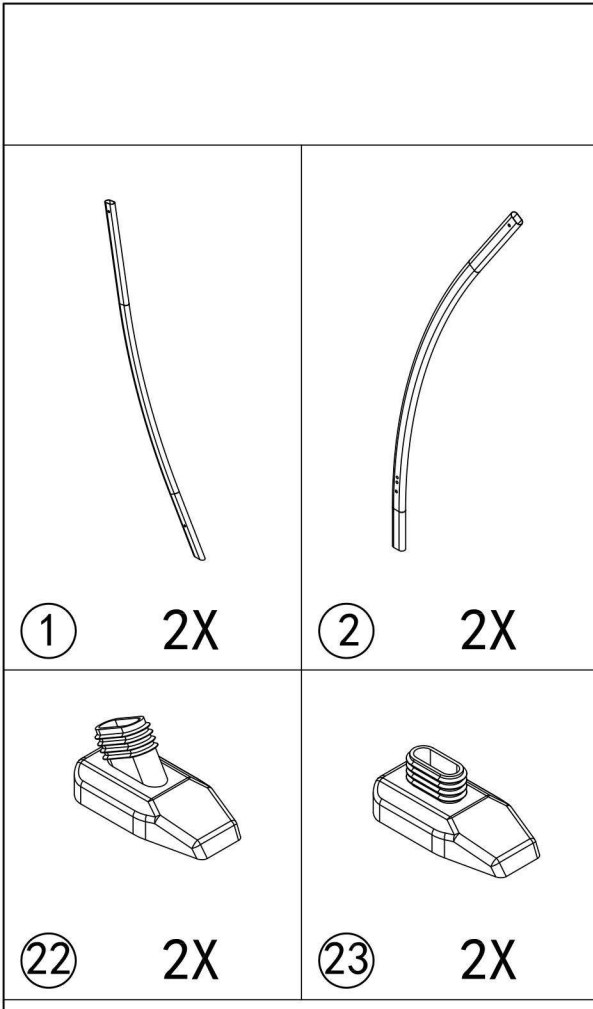

Step 1: Please find the required parts according to the instructions in the left frame, prepare a wooden hammer, and knock the plastic foot pad (Part 22) into the leg tube (Part 1), knock Part 23 into the Part 2 as shown.

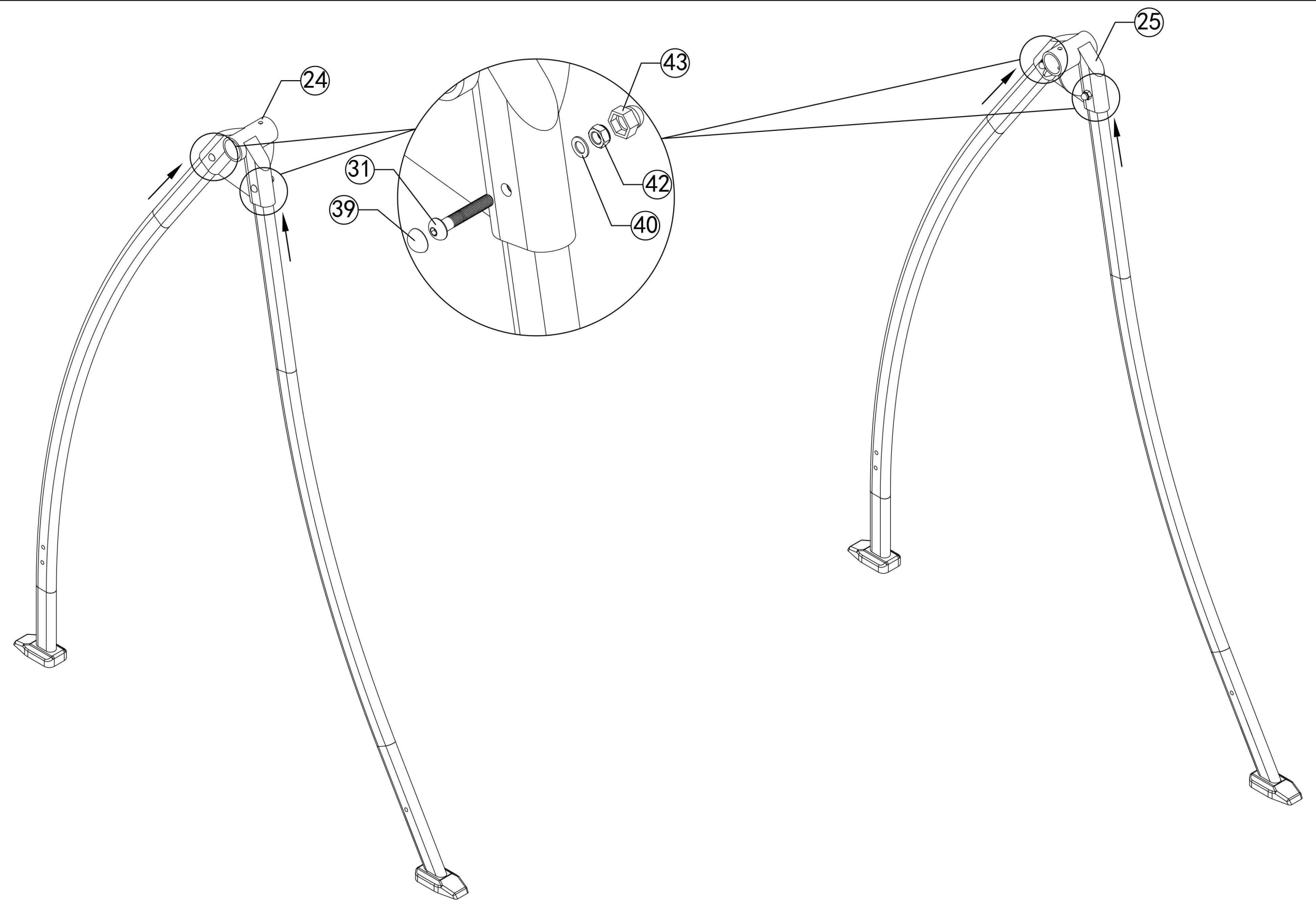
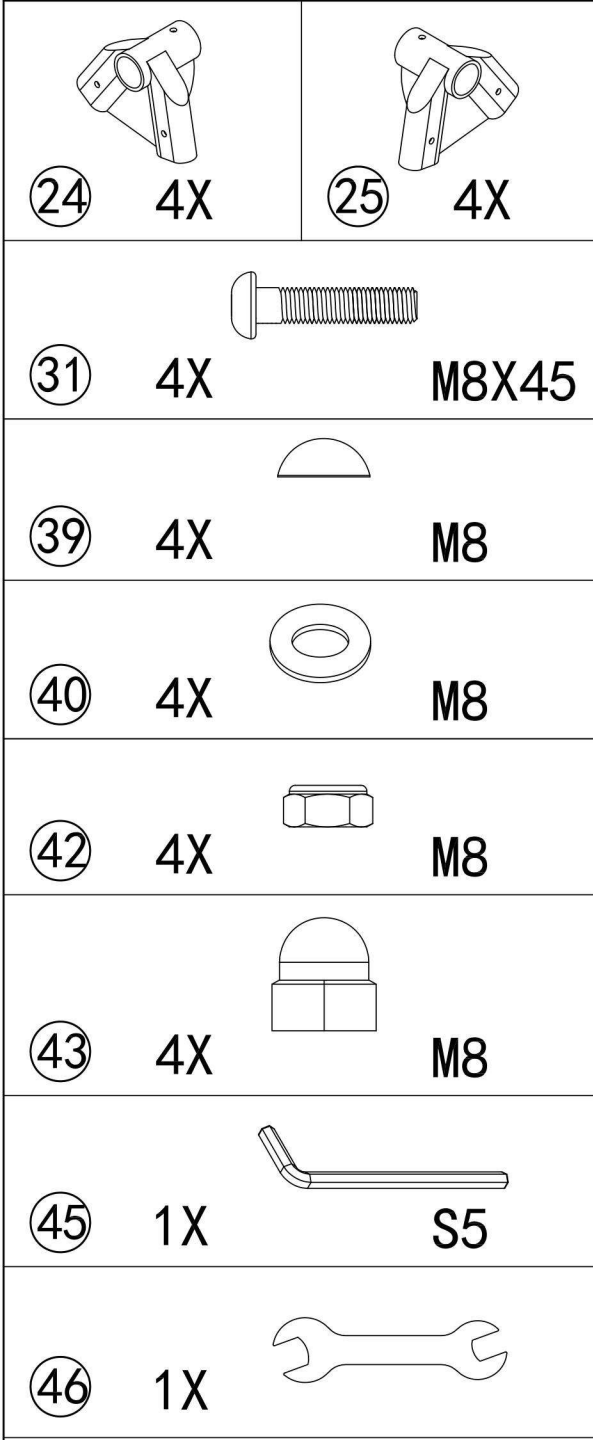

Step 2: Put the front and rear leg tubes (Part 1 is front leg tube, Part 2 is rear leg tube) into the fixator (Part 24 and Part 25) as shown, and secure with bolts and nuts as required (After all the bolts are assembled in place, tighten them together, finally cover the caps).

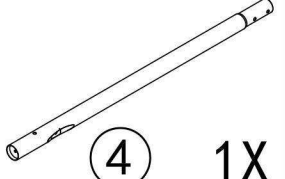
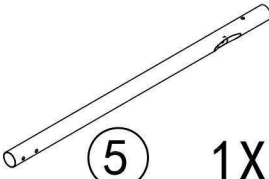
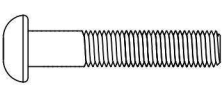
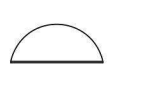
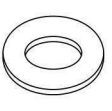
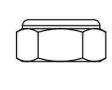
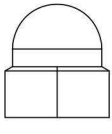
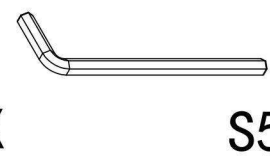
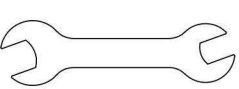
-  ④ 1X
-  ⑤ 1X
-  ③② 2X M8X55
-  ③⑨ 2X M8
-  ④① 2X M8
-  ④② 2X M8
-  ④③ 2X M8
-  ④⑤ 1X S5
-  ④⑥ 1X

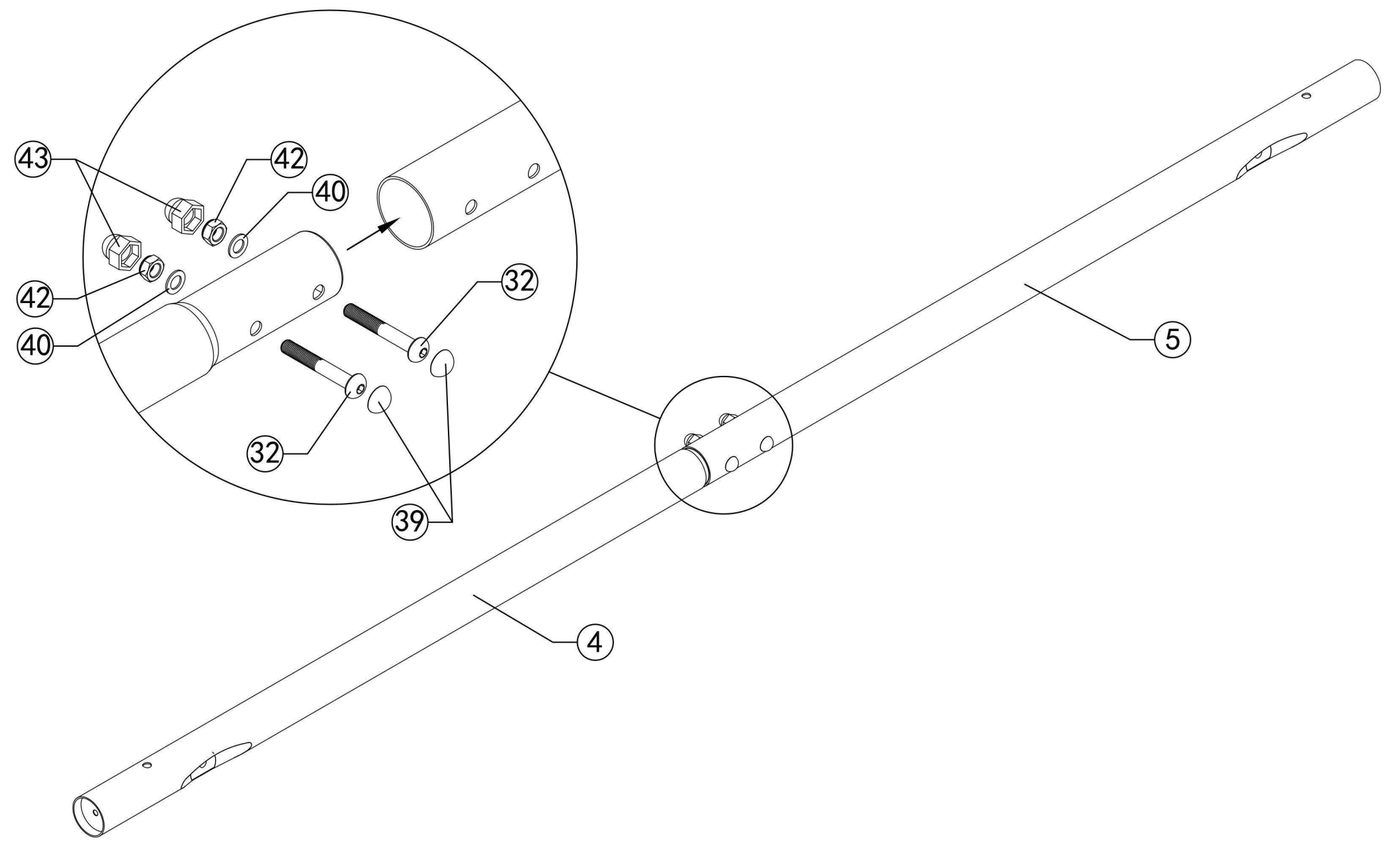



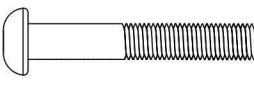
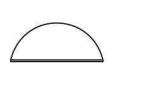
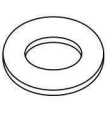
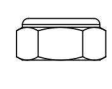
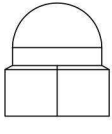
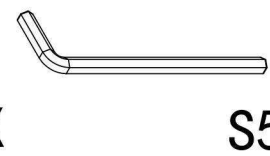
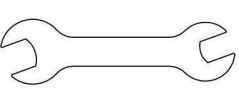

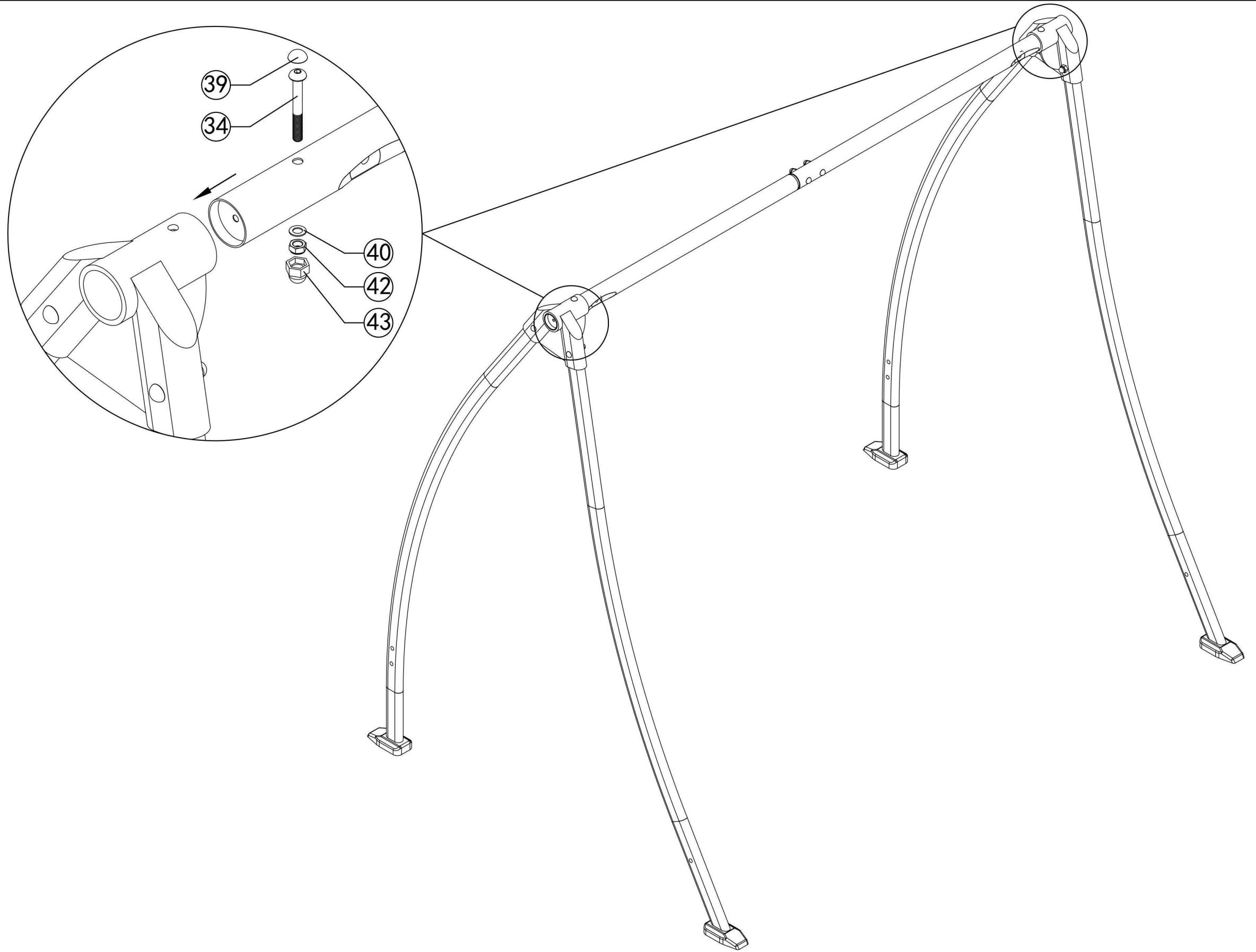
Step 3: Insert the left and right beams(Part 4 and Part 5) as show, and secure with bolts and nuts as required(Afterall the bolts are assembled in place, tighten them together, finally cover the caps).

-  ③④ 2X M8X65
-  ③⑨ 2X M8
-  ④① 2X M8
-  ④② 2X M8
-  ④③ 2X M8
-  ④⑤ 1X S5
-  ④⑥ 1X

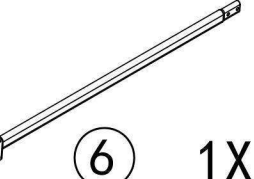
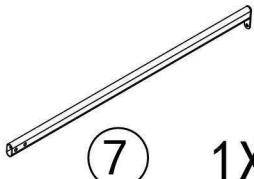
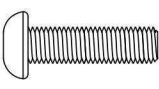
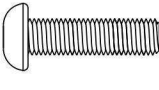



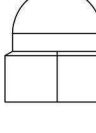
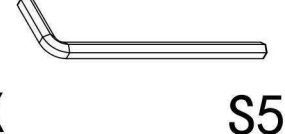
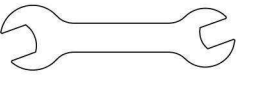

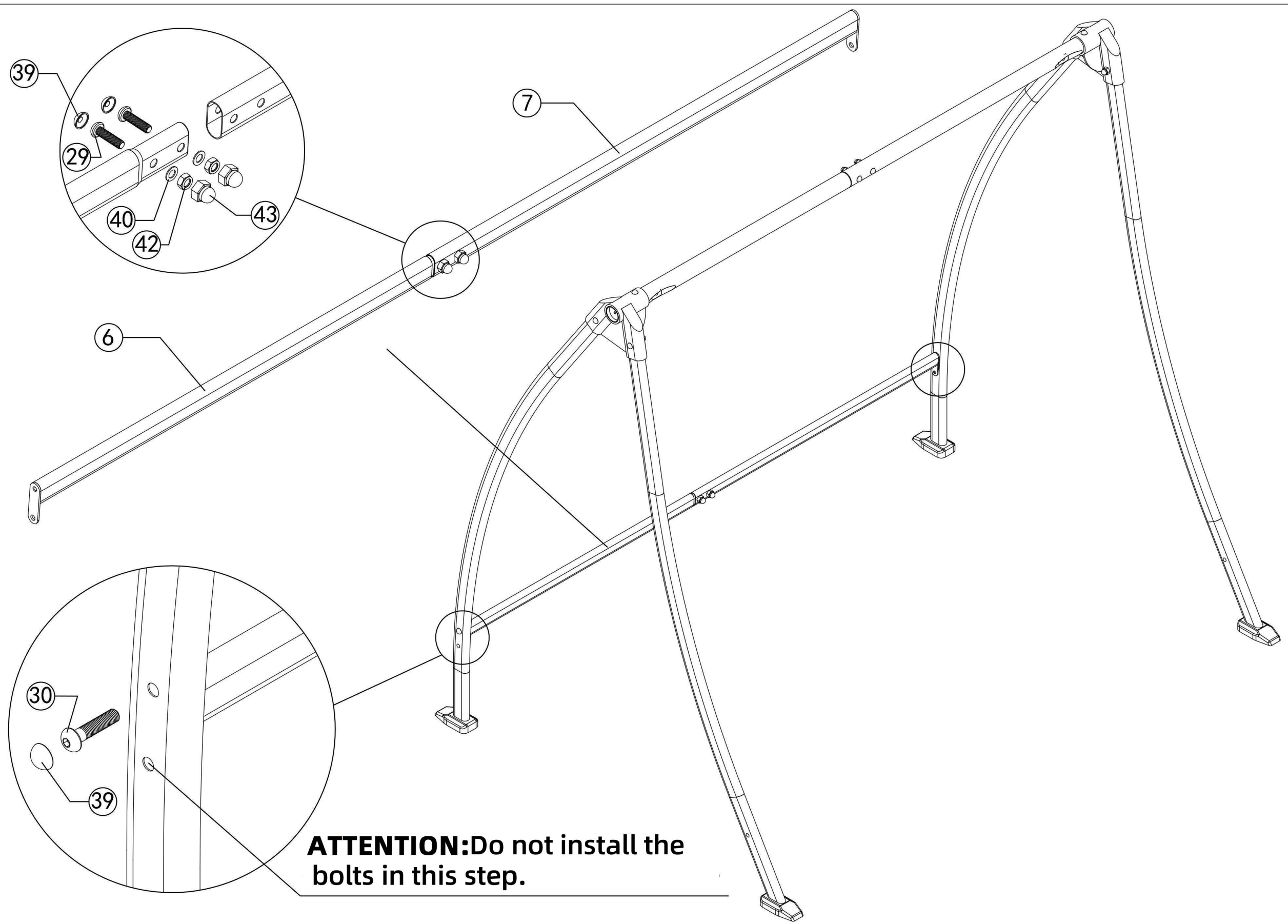

Step 4: Put the beam(Part 4 & Part 5) assembly into the fixator according as shown, and secure with bolts and nuts as required (After all the bolts are assembled in place, tighten them together, finally cover the caps).

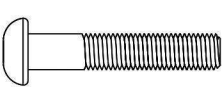
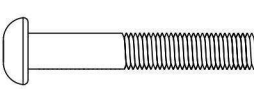
-  ⑥ 1X
-  ⑦ 1X
-  ②⑨ 2X M8X30
-  ③① 2X M8X35
-  ③⑨ 4X M8
-  ④① 2X M8
-  ④② 2X M8
-  ④③ 2X M8
-  ④⑤ 1X S5
-  ④⑥ 1X

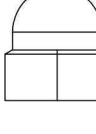

Step 5: Insert the left and right bars (Part 6 & Part 7) as shown, and secure with bolts and nuts. Then connect the bar (part 6 and Part 7) to the rear leg tubes (Align the first holes and secure the bolts). After all the bolts are assembled in place, tighten them together, finally cover the caps.

-  ③ 2X
-  ③② 2X M8X55
-  ③③ 2X M8X60
-  ③⑨ 4X M8
-  ④① 4X M8
-  ④① 4X M8
-  ④② 4X M8
-  ④③ 4X M8
-  ④⑤ 1X S5
-  ④⑥ 1X

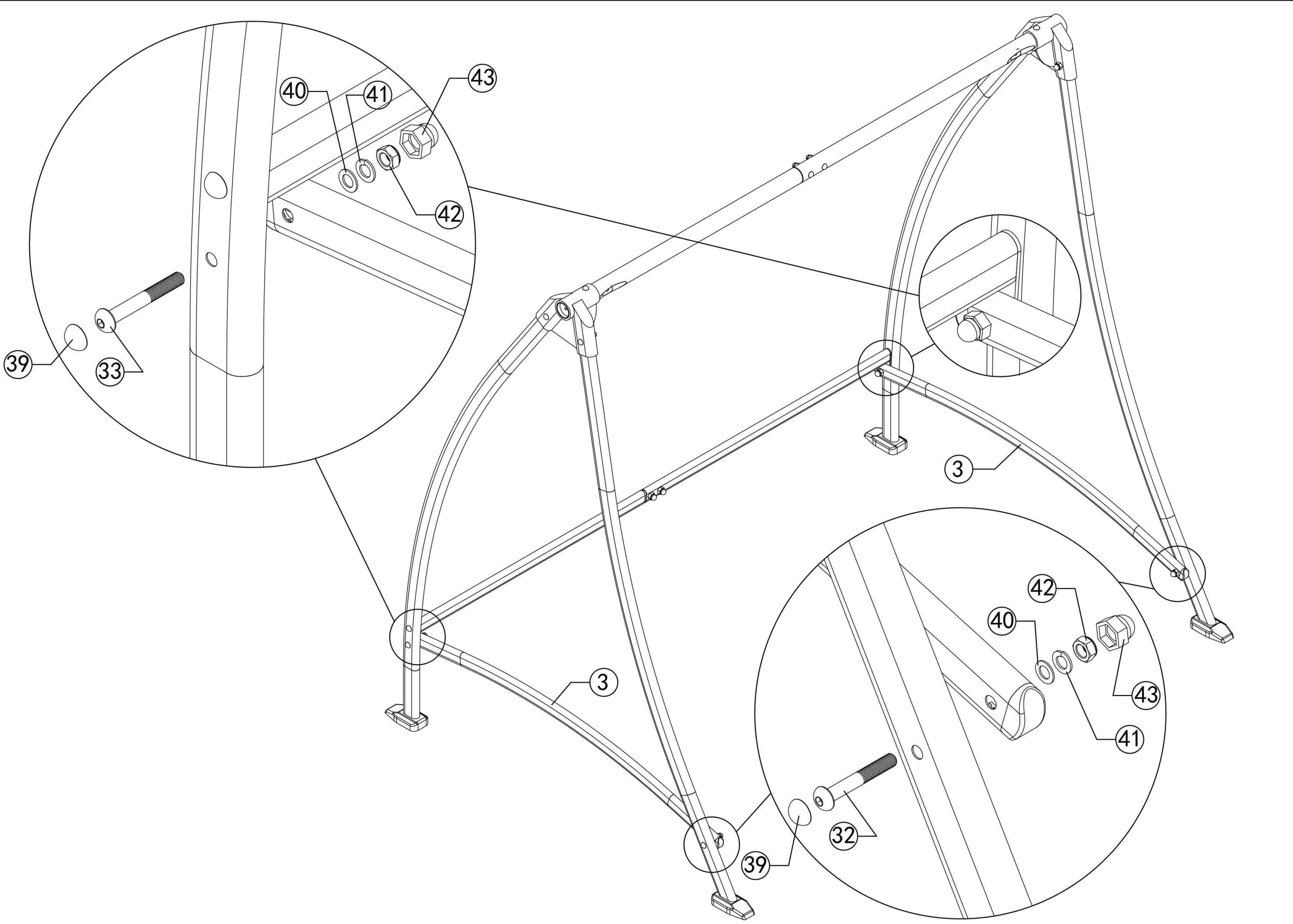



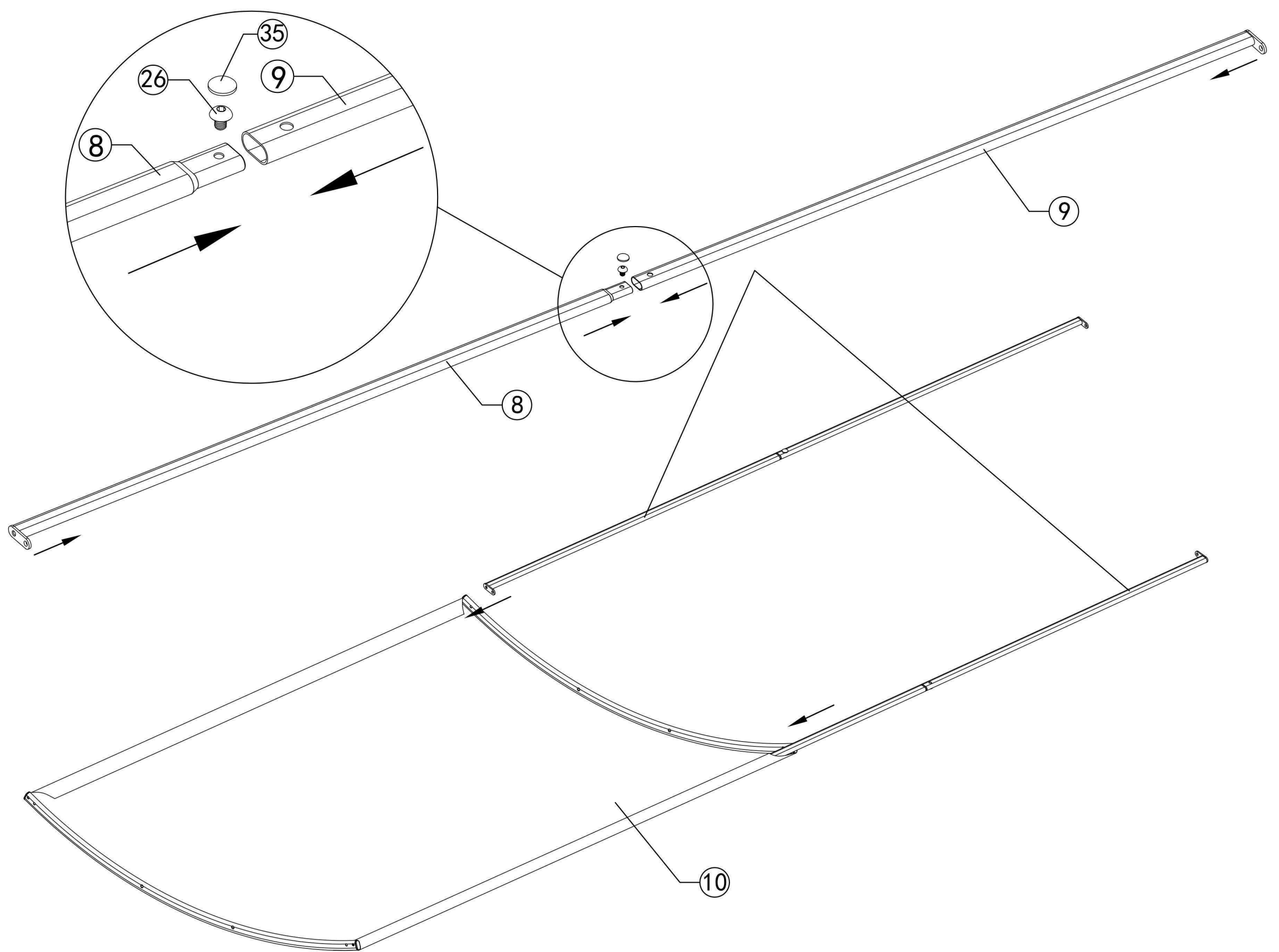
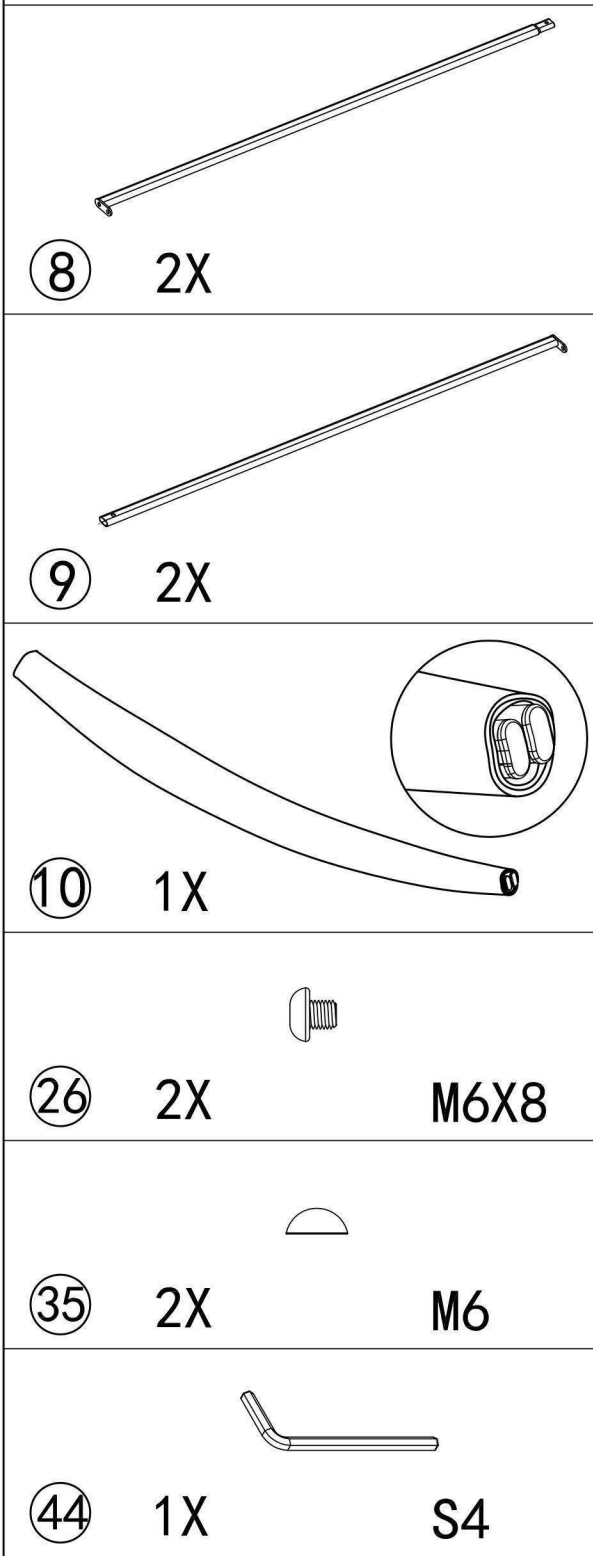

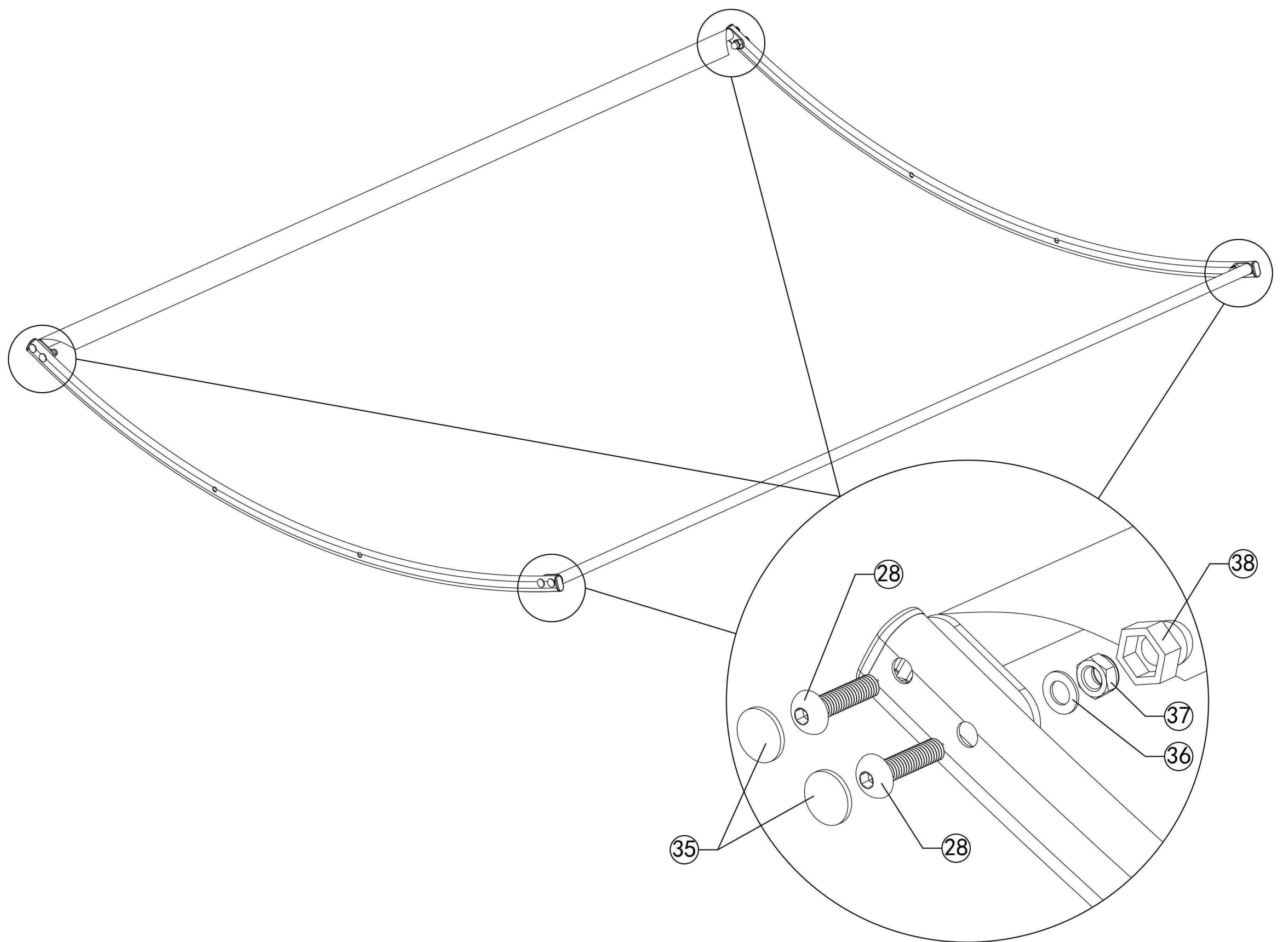
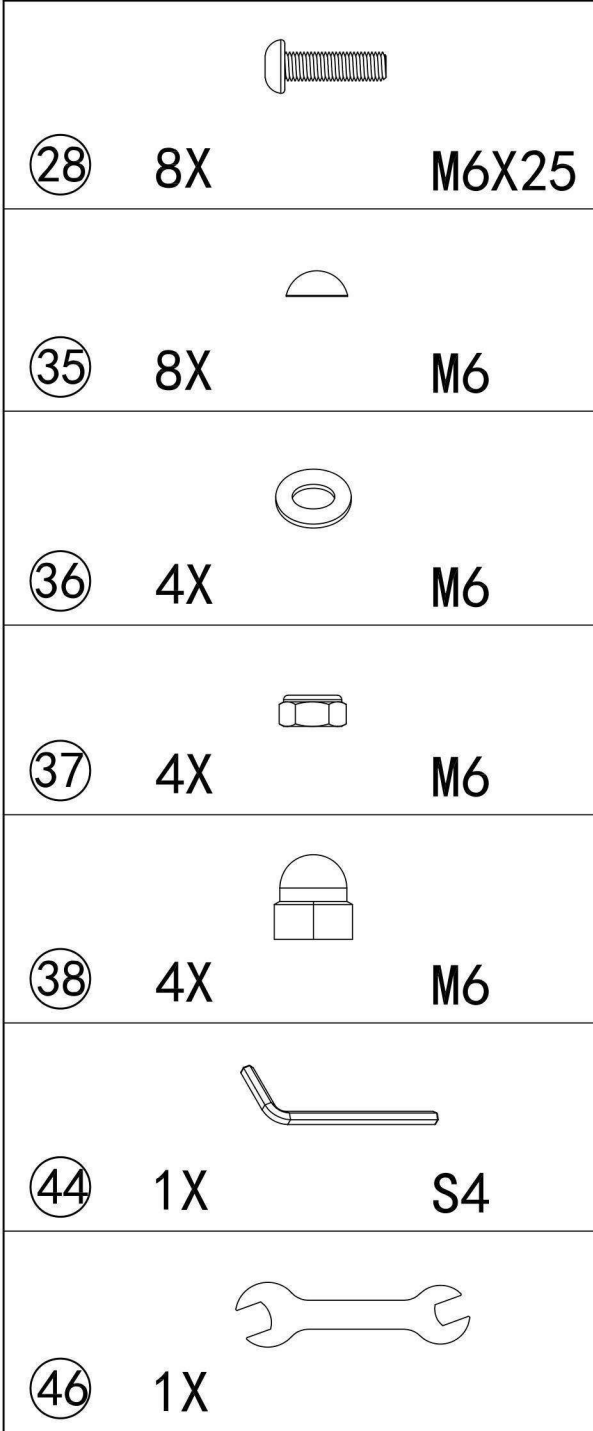

Step 6: Assemble the Part 3 to the front and rear leg tubes (Align the second holes and secure the bolts). Secure with bolts and nuts as required (After all the bolts are assembled in place, tighten them together, finally cover the caps).

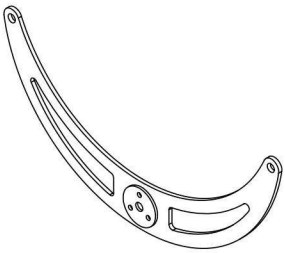

Step 7: Connect the roof tubes (Part 8 & Part 9) as shown, and secure with bolts and nuts as required (After all the bolts are assembled in place, tighten them together, finally cover the caps). Then gently Insert the assembled roof tubes(Part 8 & Part 9) into the canopy (Part 10).

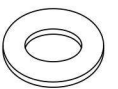

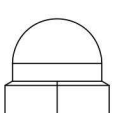
Step 8: Secure the four corners of the canopy with bolts and nuts as required (After all the bolts are assembled in place, tighten them together, finally cover the caps).

- ①① 2X 
- ②⑨ 4X M8X30 
- ③⑨ 4X M8 
- ④① 4X M8 
- ④② 4X M8 
- ④③ 4X M8 
- ④⑤ 1X S5 
- ④⑥ 1X 

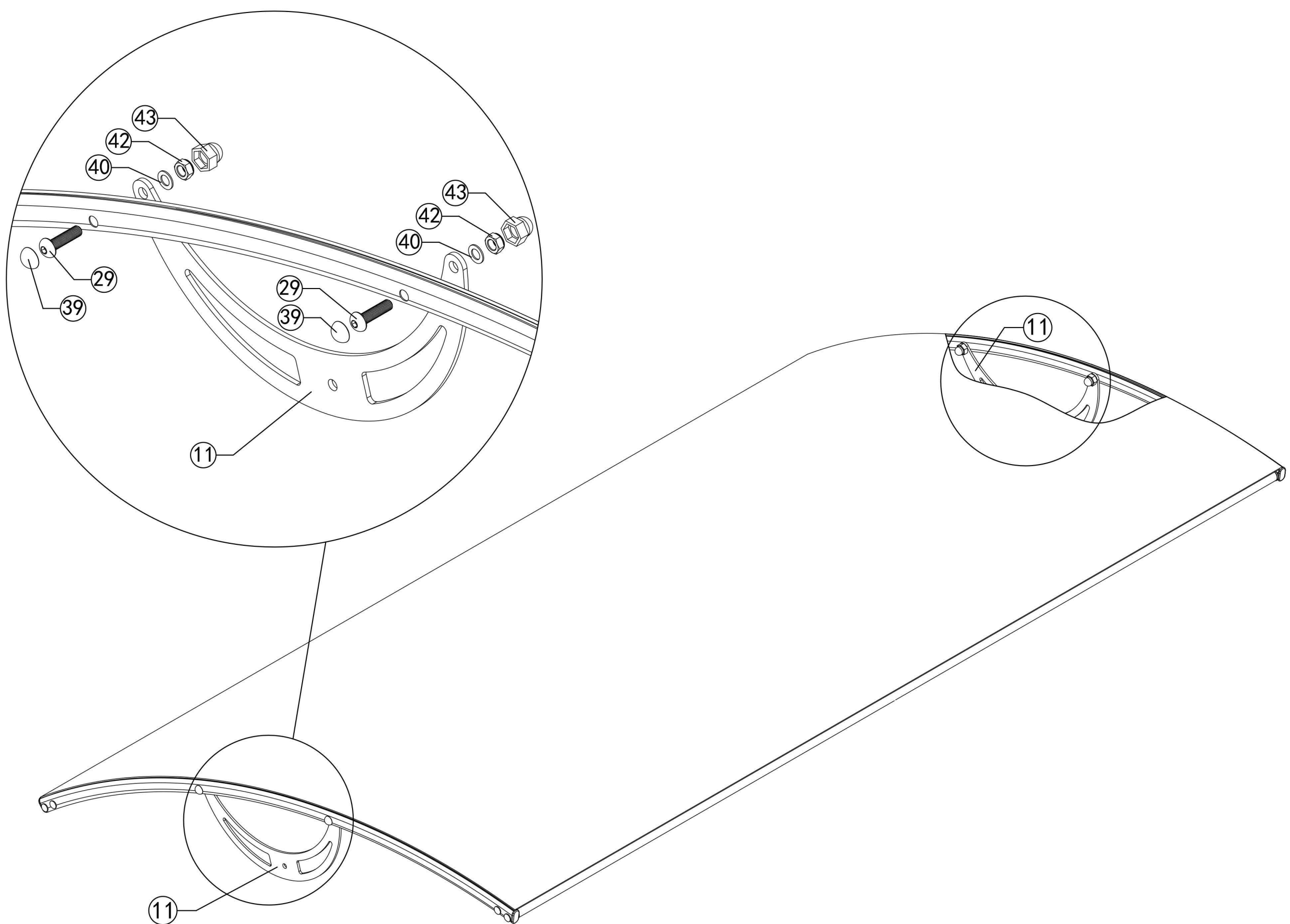

Step 9: Install Part 11 to top canopy. Align the holes and secure with bolts and nuts as required as required (After all the bolts are assembled in place, tighten them together, finally cover the caps).

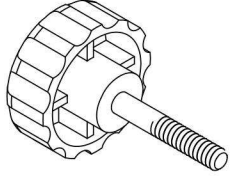
- ②① 2X 

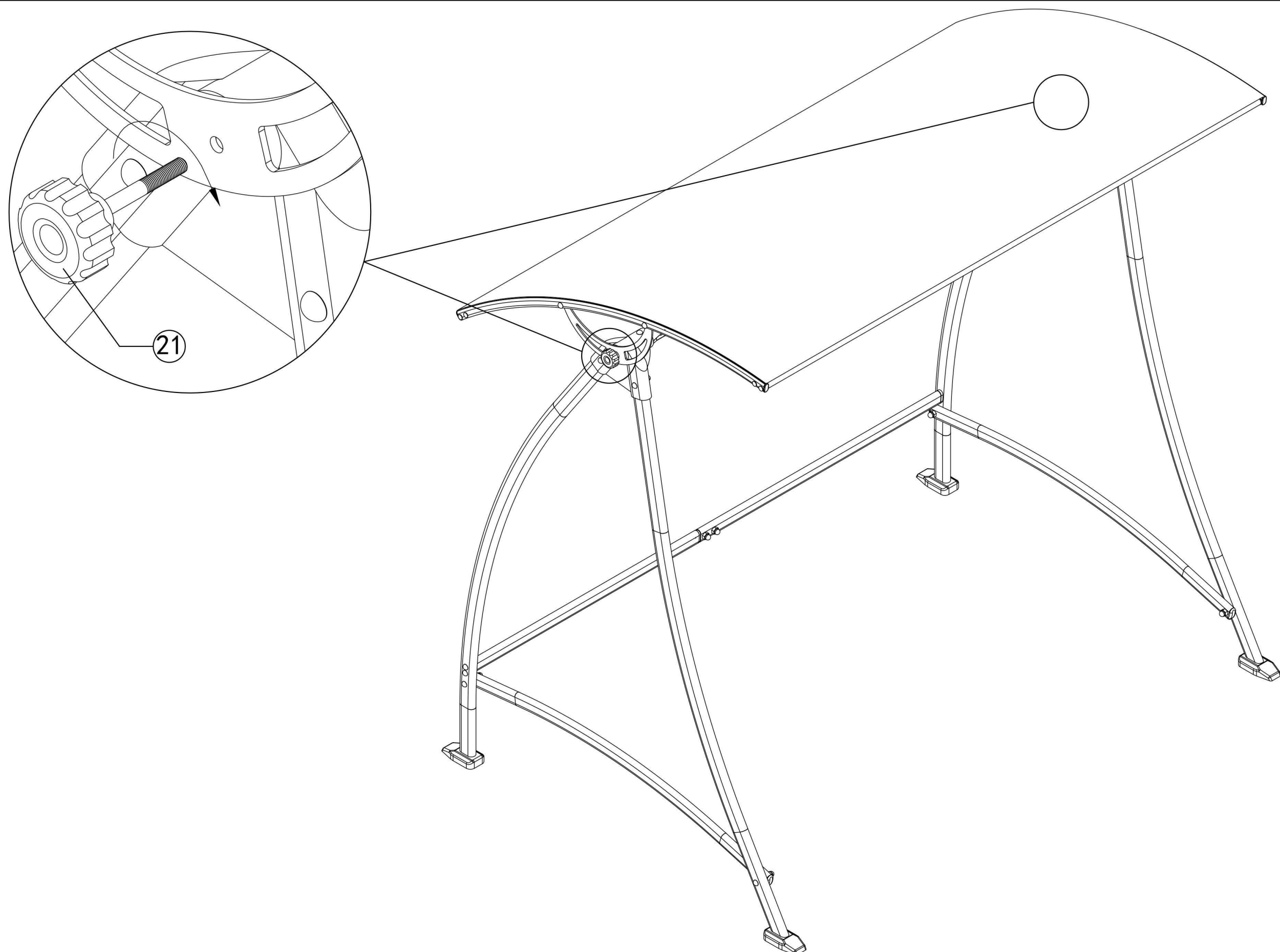

Step 10: Fix the canopy on the assembled leg frame with the adjusting knob (Part 21) as shown. Attention: According to your own requirements to adjust canopy roof, then tighten the knob.

12	2X	
13	1X	
14	1X	
39	6X	M8
30	6X	M8X35
45	1X	S5

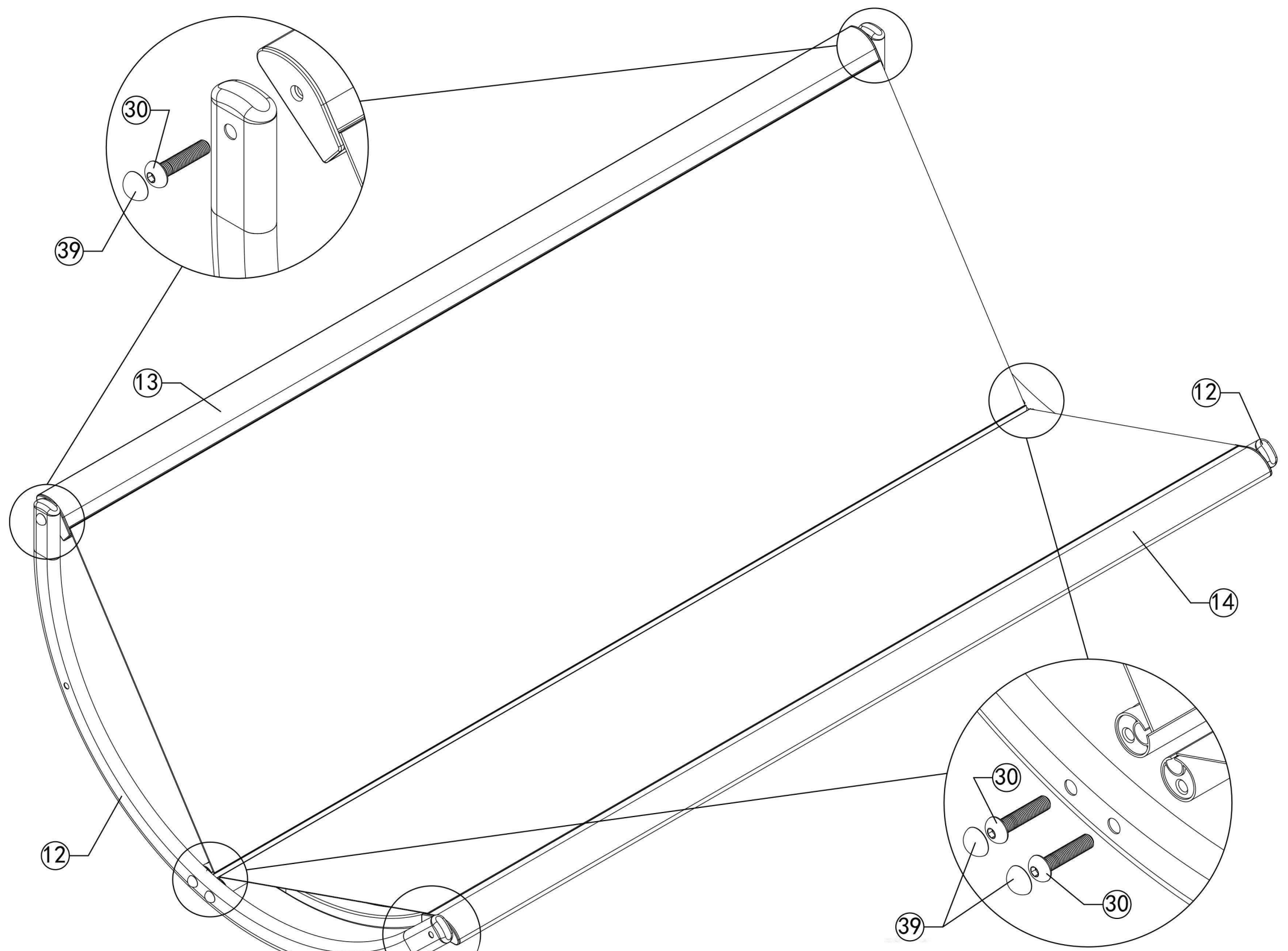

ATTENTION:
Do not install the bolts in this step.



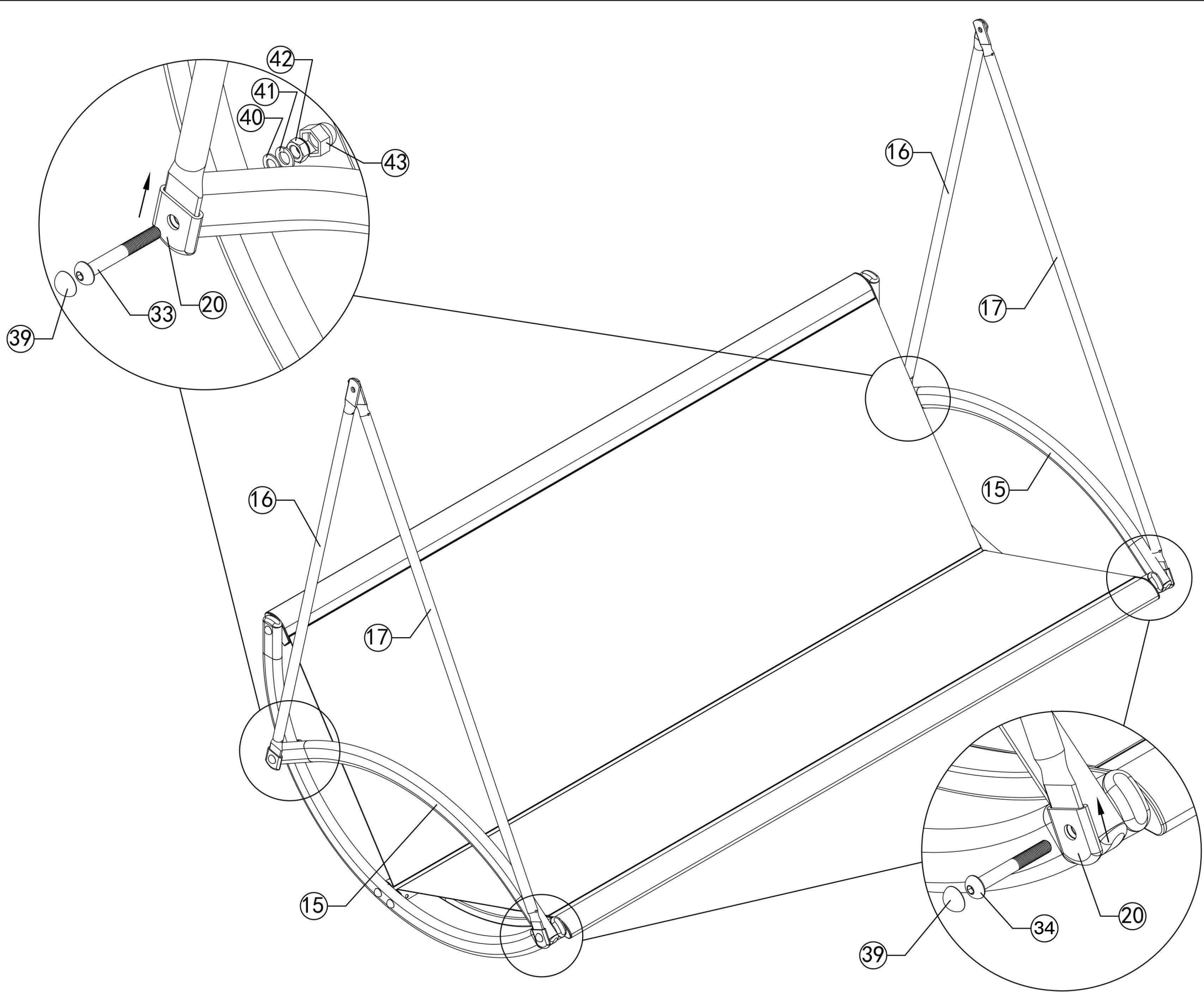

Step 11: Use bolt #30 to secure fixing tube (Part 12) on back (part 13) and seat (Part 14) as shown, secure with bolts and nuts as required (After all the bolts are assembled in place, tighten them together, finally cover the caps).

15	2X	
16	2X	
17	2X	
20	4X	
33	2X	M8X60
34	2X	M8x65
39	4X	M8
40	2X	M8
41	2X	M8
42	2X	M8
43	2X	M8
45	1X	S5



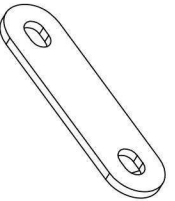

Step 12: Install swing booms and armrests. First fit part 20 on short swing booms (Part 16) and long swing booms (Part 17). Then align the holes and secure with bolts and nuts as required (After all the bolts are assembled in place, tighten them together, finally cover the caps).

46	1X	
----	----	--

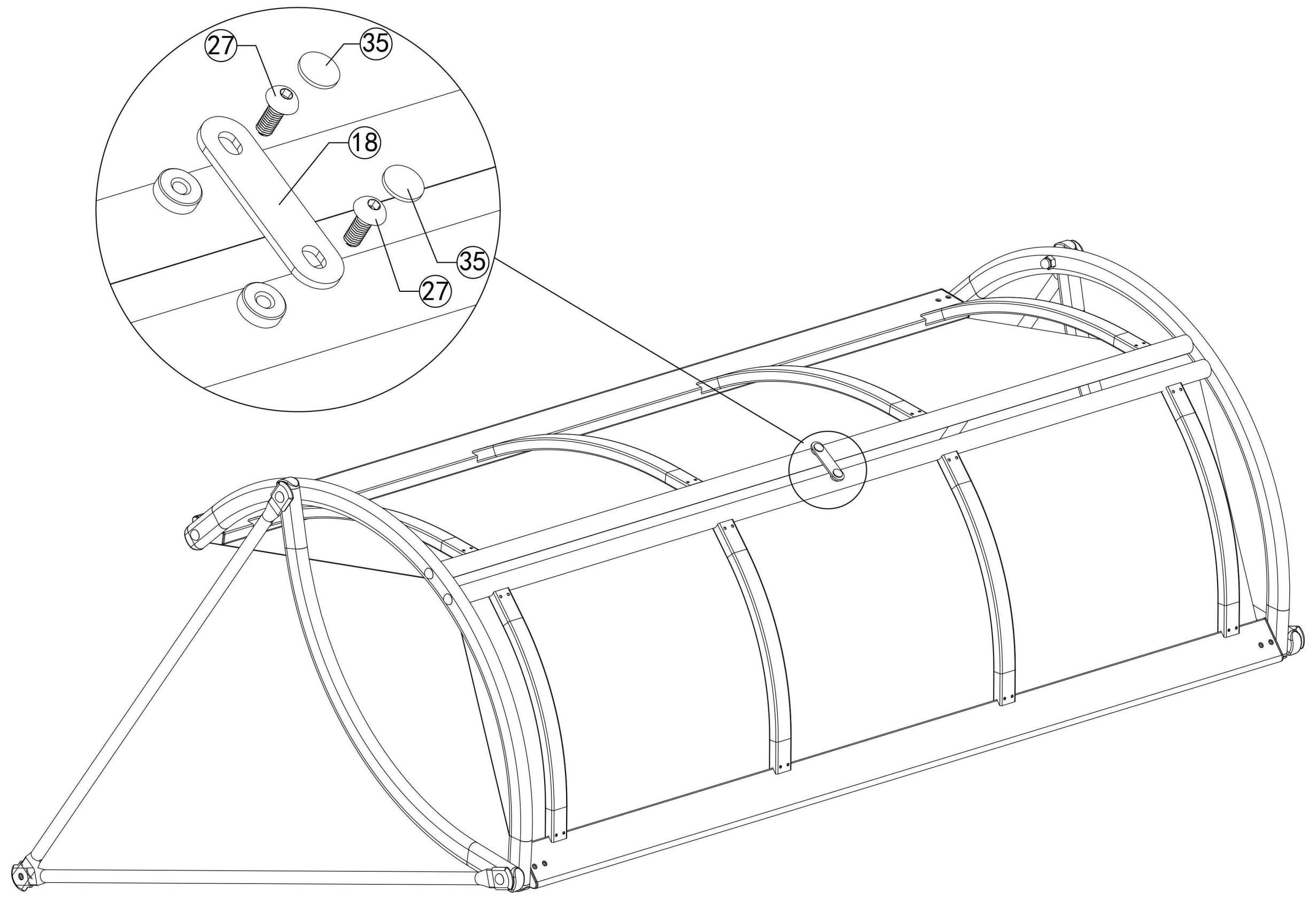
- ⑱ 1X 
- ⑳ 2X  M6X16
- ㉓ 2X  M6
- ㉔ 1X  S4

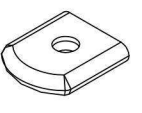

Step 13: Use Bolt #27 to secure fixing connector (Part 18) on back and seat. Align the holes and secure with bolts and nuts as required (After all the bolts are assembled in place, tighten them together, finally cover the caps).

- ㉔ 4X 
- ㉕ 2X 

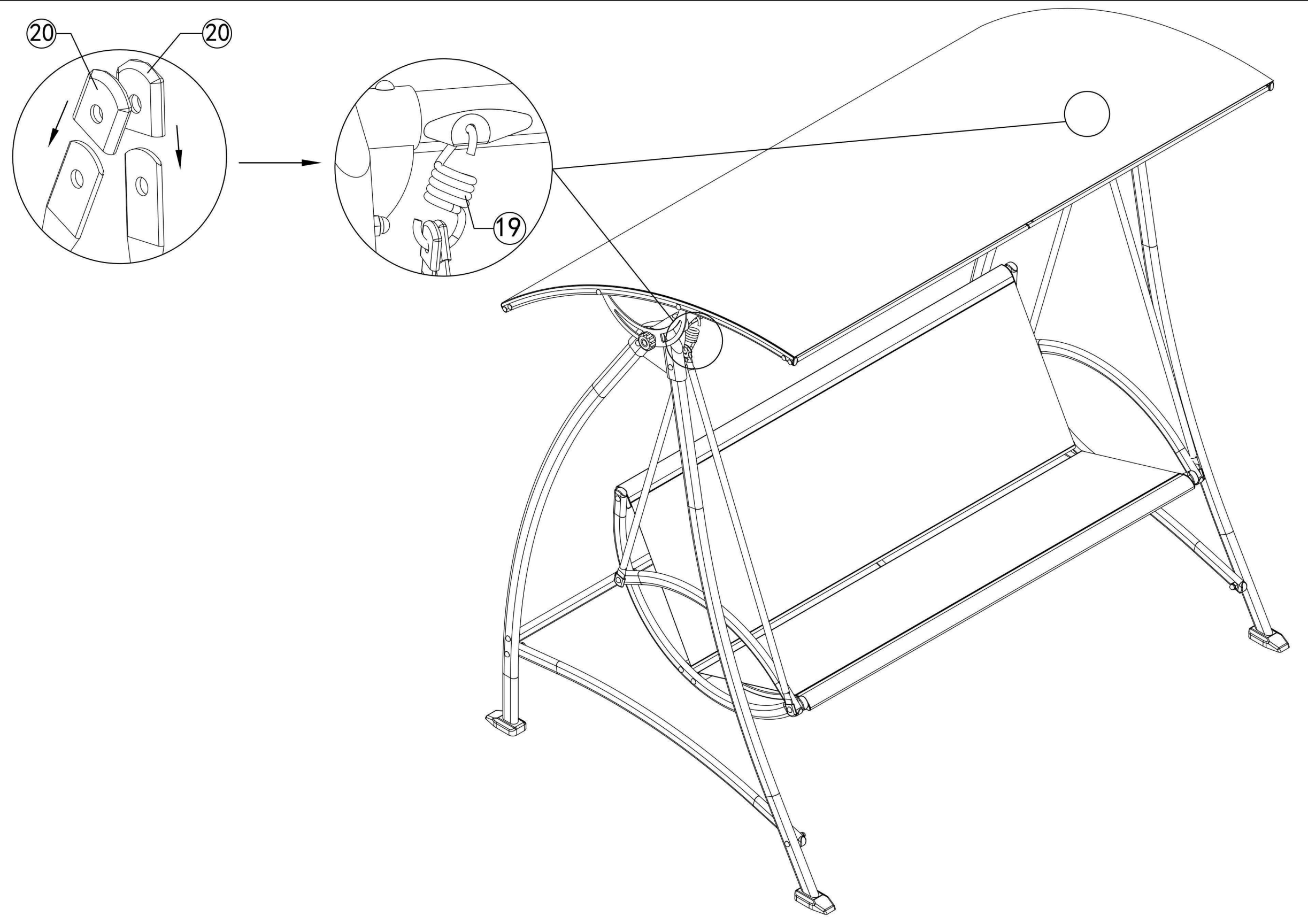

Step 14: :Insert Part 20 into the swing booms as shown, and hang it on the swing beam with hanging spring (Part 19).

