

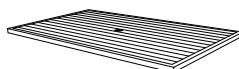





ASSEMBLE INSTRUCTION

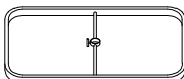
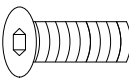

<p>A</p>  <p>x1</p>	<p>E</p>  <p>Ø6.5*1.0 x24</p>
<p>B</p>  <p>x2</p>	<p>F</p>  <p>1/4"x18 x8</p>
<p>C</p>  <p>x4</p>	<p>G</p>  <p>1/4"x28 x16</p>
<p>D</p>  <p>x1</p>	<p>H</p>  <p>x1</p>

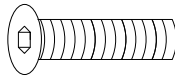
1

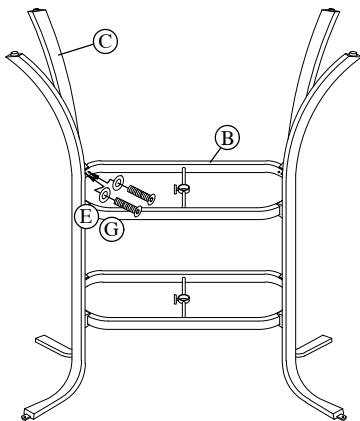

2

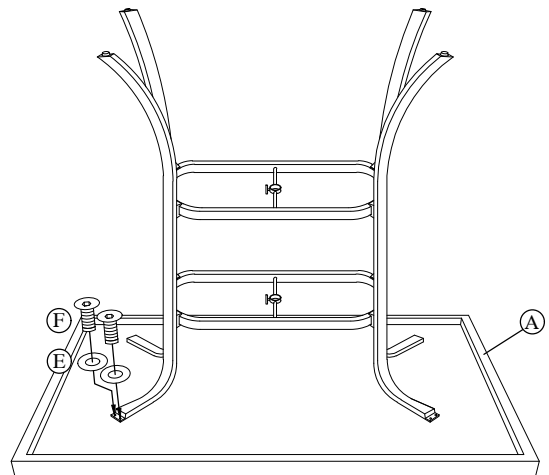

1. Fix all the screws in place, without tightening them first.
2. After confirming the position of all the screws, tighten the screws and nuts.