

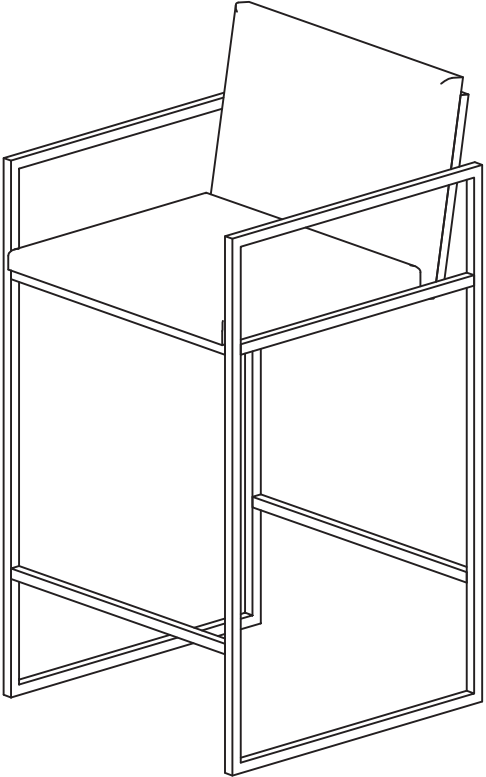

# ASSEMBLY INSTRUCTION

## Counter Stool





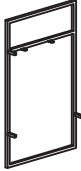
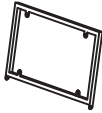

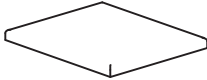
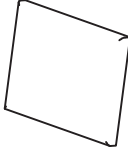
XS22226CS



### Component List

LABEL		DESCRIPTION	QTY
1		Right leg	1
2		Back frame	1
3		Left leg	1
4		Beams	3
5		Seat	1
6		Back	1

# Hardware List

LABEL		DESCRIPTION	QTY
A		Bolt (M6*12mm)	14
B		Bolt (M6*20mm)	4
C		Bolt (M6*25mm)	2
D		Bolt (M6*16mm)	4
E		Screw	4
F		Allen Wrench	1

②

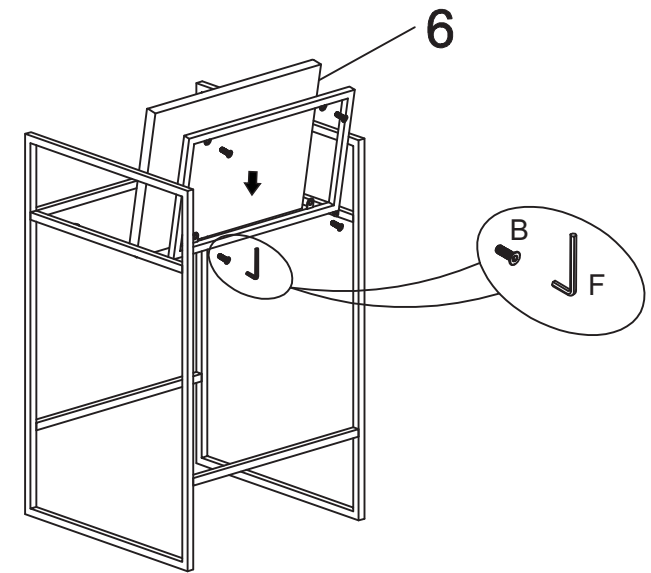

①

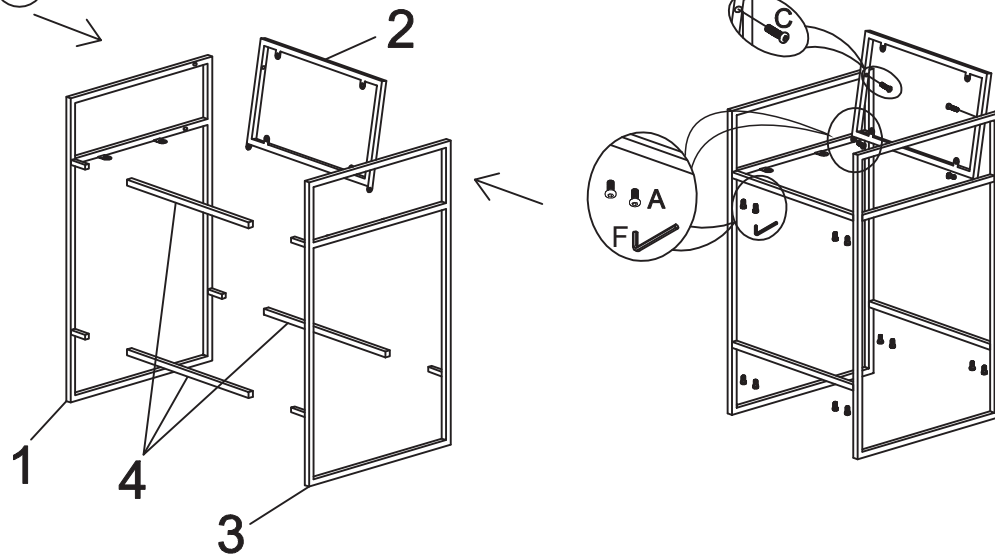

③

