

ASSEMBLY INSTRUCTION

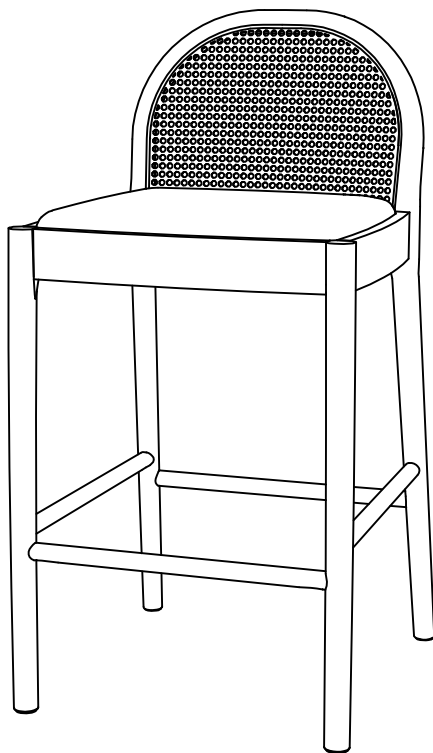

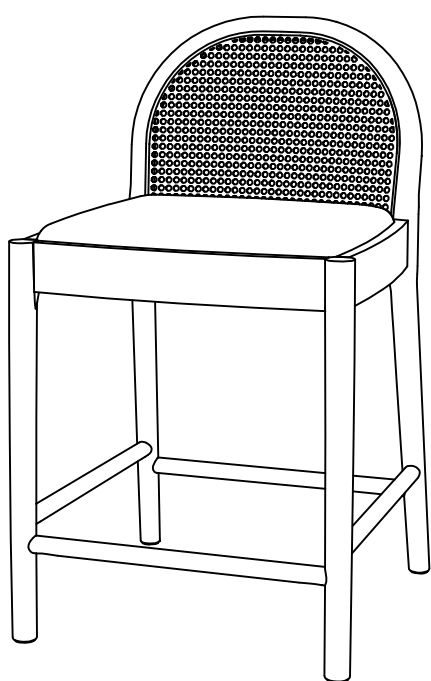

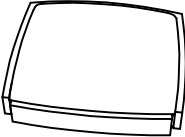
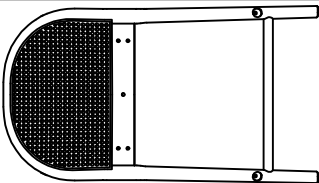
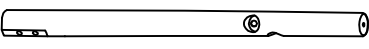
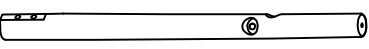
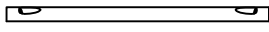
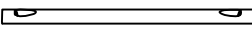

Counter chair & Bar chair
TN-5696L & TN-5696H



Component List

LABEL		DESCRIPTION	QTY
A		Seat	1
B		Back	1
C		Front leg	1
D		Front leg	1
E		Front footrest (Longer)	1
F		Side footrest (Shorter)	2

Hardware List

LABEL		DESCRIPTION	QTY
H1		Adjust gliders	2
H2		Blots M6×45mm	6
H3		Blots M8×50mm	5
H4		Blots M8×75mm	4
H5		Spring washer M8	9
H6		Flat washer M8×22×1.5mm	9
H7		Allen key M6	1

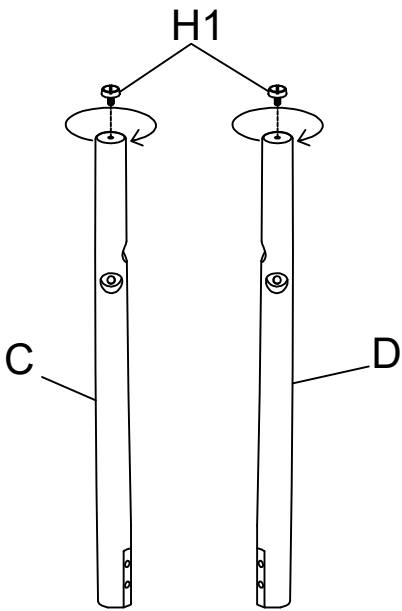
1

Fully tighten the adjust gliders.

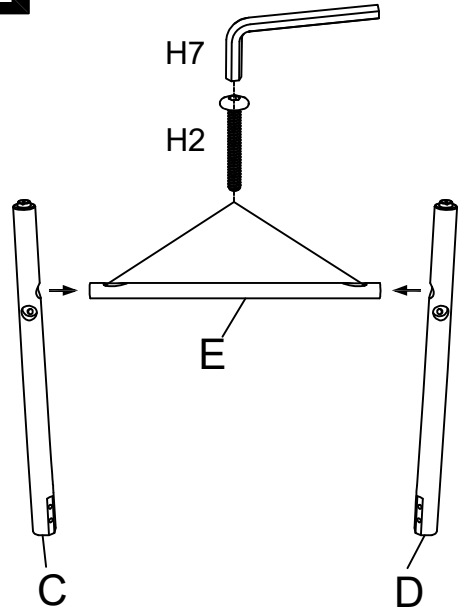
2

Tighten the bolts to 80% tightness.

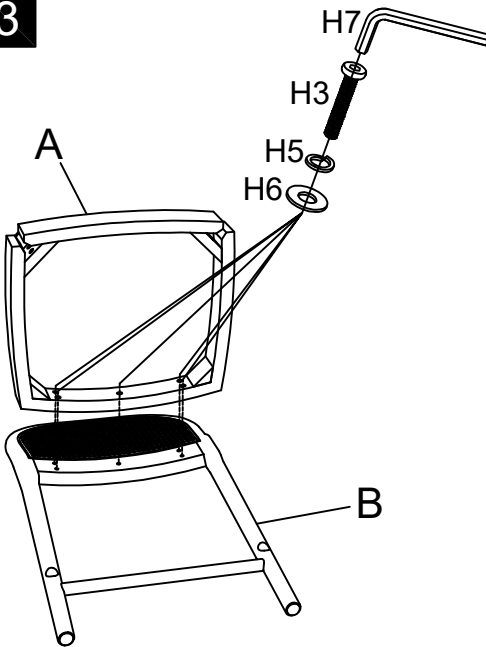
3

Tighten the bolts to 80% tightness.

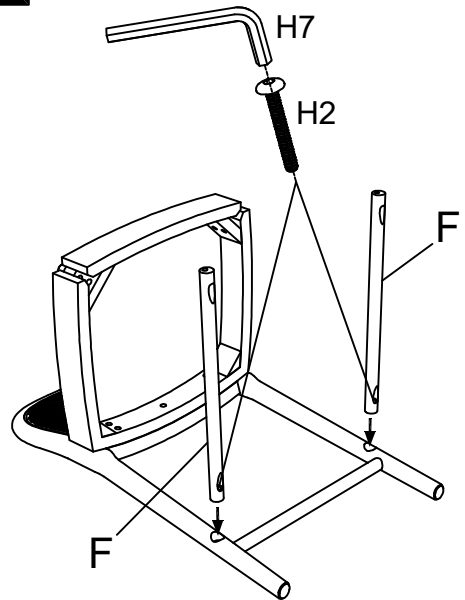
4

Tighten the bolts to 80% tightness.

5

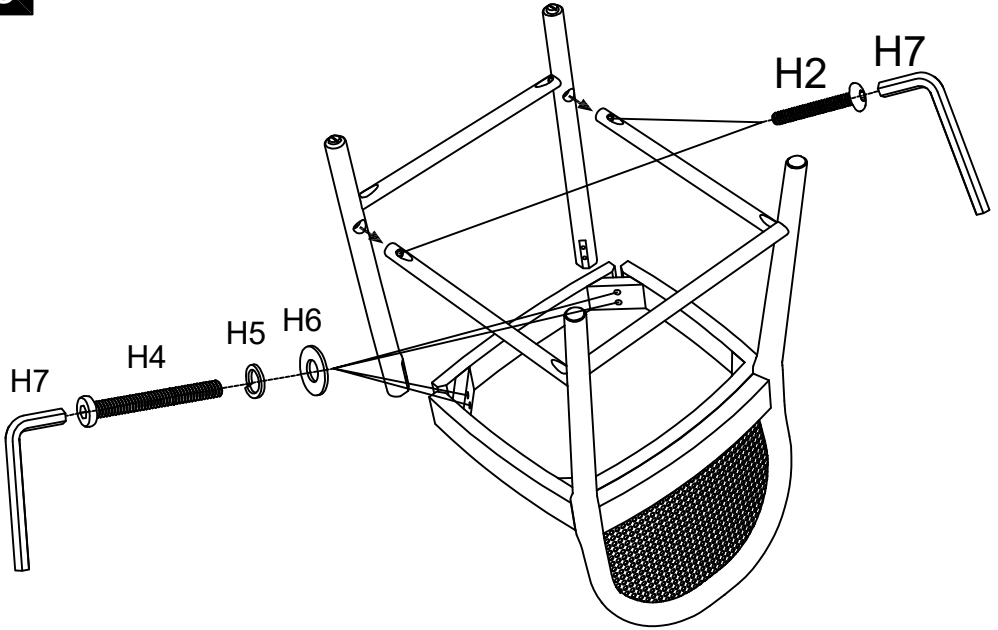

Tighten the bolts to 80% tightness.

6

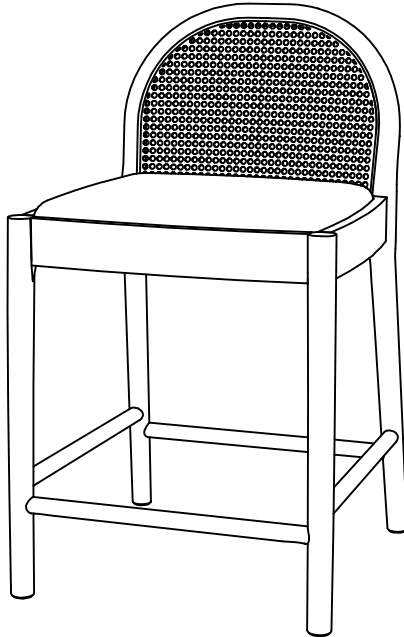

Adjust the chair so that it is leveled, then fully tighten all the bolts.