

FILM TELEVISION LIGHTING

SYSTEM SOLUTION



Selens

2024



SUPPORT YOUR IMAGINATION

| About Selens

Selens was founded in 2011 and has been in the industry of photography lighting equipment and related accessories for 12 years. Selens is committed to provide excellent solutions to behind-the-scenes workers in the field of photography and film making. We attach great importance to user experience and listen carefully to needs and desires, which inspires us to create better products that help users to complete their jobs more easily and efficiently.

Selens' products focus on user-friendly, simple and convenient concepts, allowing users to focus on creation and allowing imagination to be freely released without the constraints of technical problems.

Selens products are engineered to provide incredible strength and durability in the toughest environments and are recognized by industry professionals.



Icon Description



Maximum Height



Minimum Height



Closed Length



Spindle Diameter



Product Weight



Maximum Load



Product Size

Contents

04 APOLLO COB Lights

14 APOLLO RGBACL Panel Lights

16 LED Spotlights

18 FLEXI PANEL Flexible Fabric Lights

20 PROTUBE Tube Lights

24 ALADDIN Pocket Lights

28 Lighting Accessories

30 Edge Parabolic Reflectors

36 Softboxes

46 Compact Fold-Away Butterfly Frames

48 Flag & Frames

49 Reflectors

50 Umbrellas

52 Air Cushion Stands

54 Lightweight Stands

55 Click Stands

56 Roller Column Stands

58 C-Stands

62 Heavy Duty Stands

68 Backlight Stands

70 Wall Booms

71 Wall Mount Booms

72 Super Viser Clamps

73 C-Stand Accessories

76 Super Clamps

77 Studio Accessories

78 Background Supports

79 Chroma Key Backgrounds

82 Screen Suits

83 Collapsible Pattern Backgrounds

Excellent Brightness, Restore Realistic Colors

APOLLO COB Light Series



APOLLO COB Lights



Apollo 100 100W
Point-Source LED
(5600K)

SLC4-100



Apollo 100X 100W
Bi-Color Point-Source LED
(2700K-6500K)

SLC4-100X

APOLLO

APOLLO 100W Point-Source LED

- Output Power: 100W
- Apollo 100 illuminance 71,500Lux@1m (5600K with hyper reflector)
- Apollo 100X illuminance 69,400Lux@1m (5600K with hyper reflector)
- CRI and TLCI ≥ 96 , High Color Accuracy
- 8 Lighting FX with 9 levels of adjustable speed
- 4 Dimmer curves (Liner, Exp, Logarithmic, S-Curve)
- The front of the COB component is protected by glass
- Active cooling, working noise ≤ 28 dB
- 3 light control methods (On-Board, 2.4G remote, Selens Link App) support group control lighting
- Bowens mount design
- 3 power supply methods (AC/DC power supply, V-Mount battery, F series battery buckle plate)

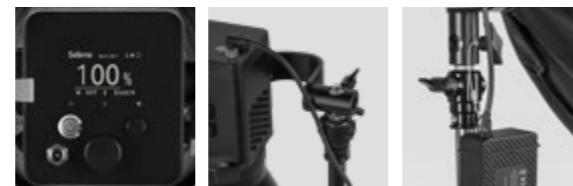
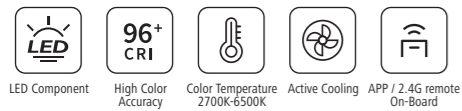
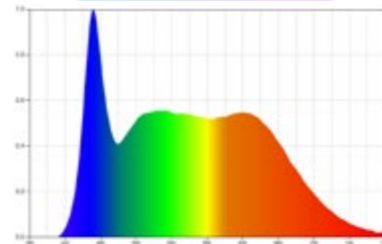
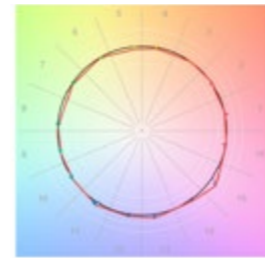

Product List

	Apollo 100W	x1
	Bowens protective cover	x1
	Bowens hyper reflector	x1
	Carry case	x1
	Power adapter (Include Hanger & Wire rope)	x1
	Power cable	x1

APOLLO COB Lights



Apollo 200 200W
Point-Source LED
(5600K)

SLC4-200



Apollo 200X 200W
Bi-Color Point-Source LED
(2700K-6500K)

SLC4-200X

APOLLO

APOLLO 200W Point-Source LED

- Output Power: 200W
- Apollo 200 illuminance 97,000Lux@1m (5600K with hyper reflector)
- Apollo 200X illuminance 51,400Lux@1m (5600K with hyper reflector)
- CRI and TLCI ≥ 96 , High Color Accuracy
- 8 Lighting FX with 9 levels of adjustable speed
- 4 Dimmer curves (Liner, Exp, Logarithmic, S-Curve)
- The front of the COB component is protected by glass
- Active cooling, working noise ≤ 28 dB
- 3 light control methods (On-Board, 2.4G remote, Selens Link App) support group control lighting
- Bowens mount design
- AC/DC power supply
- 360° rotate metal yoke, support universal head, baby pin

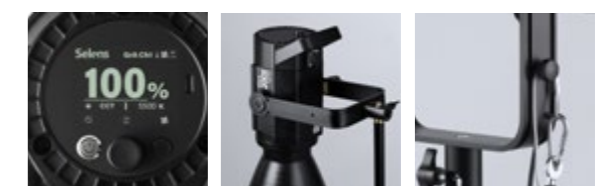
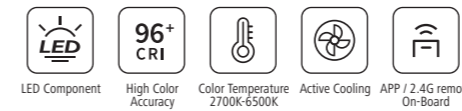
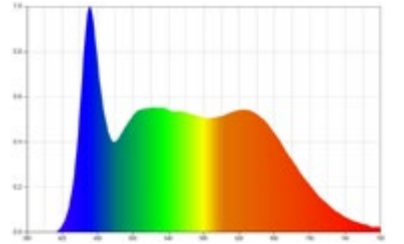
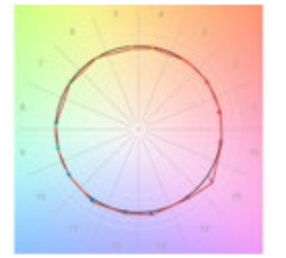

Product List

	Apollo 200W	x1
	Bowens protective cover	x1
	Bowens hyper reflector	x1
	Carry case	x1
	Power adapter (Include Hanger & Wire rope)	x1
	Power cable	x1

APOLLO COB Lights



Apollo 300 300W
Point-Source LED
(5600K)

SLC4-300



Apollo 300X 300W
Bi-Color Point-Source LED
(2700K-6500K)

SLC4-300X

APOLLO

APOLLO 300W Point-Source LED

- Output Power: 300W
- Apollo 300 illuminance 101,000Lux@1m (5600K with hyper reflector)
- Apollo 300X illuminance 71,500Lux@1m (5600K with hyper reflector)
- CRI and TLCI ≥ 96 , High Color Accuracy
- 8 Lighting FX with 9 levels of adjustable speed
- 4 Dimmer curves(Liner, Exp, Logarithmic, S-Curve)
- The front of the COB component is protected by glass
- Active cooling, working noise ≤ 28 dB
- 3 light control methods (On-Board, 2.4G remote, Selens Link App) support group control lighting
- Bowens mount design
- AC/DC power supply
- 360° rotate metal yoke, support universal head, baby pin

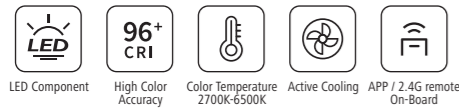
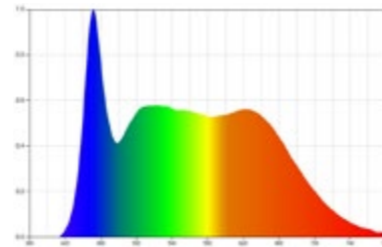
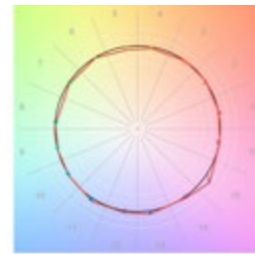

Product List

	Apollo 300W	x1
	Bowens protective cover	x1
	Bowens hyper reflector	x1
	Carry case	x1
	Power adapter (Include Hanger & Wire rope)	x1
	Power cable	x1

APOLLO COB Lights



Apollo 600 Pro 600W
Point-Source LED
(5600K)

SLC4-600Pro



Apollo 600X Pro 600W
Bi-Color Point-Source LED
(2700K-6500K)

SLC4-600XPro



Control Box

APOLLO

APOLLO 600W Pro Point-Source LED

- Output Power: 600W
- Apollo 600 Pro illuminance 189,000Lux@1m (5600K with hyper reflector)
- Apollo 600X Pro illuminance 142,000Lux@1m (5600K with hyper reflector)
- CRI ≥ 96 TLCI ≥ 96 Rf ≥ 93 Rg ≥ 100 , High Color Accuracy
- Lighting and control are separated
- AC Power Cable(5m), Head Cable(5m)
- 8 Lighting FX with 9 levels of adjustable speed
- 4 Dimmer curves(Liner, Exp, Logarithmic, S-Curve)
- The front of the COB component is protected by glass
- Active cooling
- 4 light control methods (DMX, Control box, 2.4G remote, Selens Link App) support group control lighting
- Bowens mount design
- 2 power supply (AC/DC, V-Mount Battery)
- 360° rotate metal yoke, support universal head, baby pin

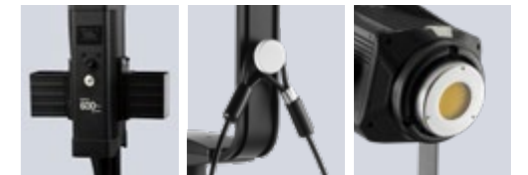
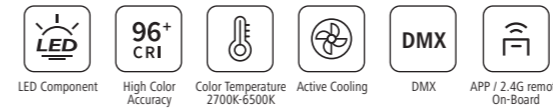
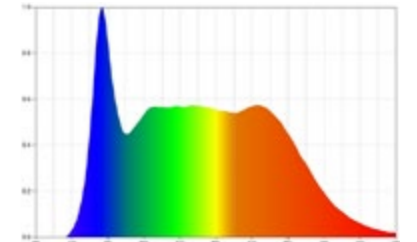
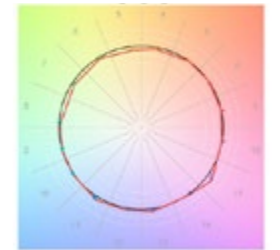

Product List

	Apollo 600W	x1	Head cable(5m)	x1
	Control box	x1	Wire rope	x1
	Lighting clamp	x1	Rolling carrying case	x1
	Bowens protective cover	x1		
	Bowens hyper reflector	x1		
	AC power cable (5m)	x1		

APOLLO COB Lights



APOLLO

APOLLO 1200X Pro 1200W
Bi-Color Point-Source LED

SLC4-1200XPro

- Output Power: 1200W
- Color temperature: 2700K-6500K
- CRI \geq 96 TLCI \geq 96 Rf \geq 93 Rg \geq 100, High Color Accuracy
- Lighting and control are separated
- AC Power Cable(5m), Head Cable(5m)
- 4 Dimmer curves(Liner, Exp, Logarithmic, S-Curve)
- The front of the COB component is protected by glass
- Active cooling, working noise \leq 28dB
- 4 light control methods (DMX, Control box, 2.4G remote, Selens Link App) support group control lighting
- Bowens mount design
- AC/DC power supply
- 360° rotate metal yoke support universal head, baby pin

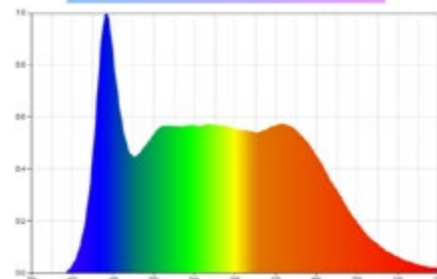
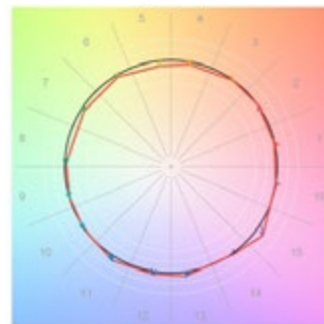

Product List

	Apollo 1200W	x1	Head cable (5m)	x1
	Control box	x1	Wire rope	x1
	Lighting clamp	x1	Rolling carrying case	x1
	Bowens protective cover	x1		
	Bowens hyper reflector	x1		
	AC power cable (5m)	x1		

APOLLO COB Lights



APOLLO

APOLLO 1200S Pro 1200W
RGBACL Point-Source LED

SLC4-1200SPro



- Output Power: 1200W
- Color temperature: 2000K-20000K
- Apollo 1200S PRO use Selens RGBACL six-color light engine provides more accurate colors
- CRI \geq 96, TLCI \geq 96, Rf \geq 94, Rg \geq 103, High Color Accuracy
- Lighting and control are separated
- AC Power Cable(5m), Head Cable(5m)
- 4 Dimmer curves(Liner, Exp, Logarithmic, S-Curve)
- The front of the COB component is protected by glass
- Active cooling, working noise \leq 28dB
- 4 light control methods (DMX, Control box, 2.4G remote, Selens Link App) support group control lighting
- Bowens mount design
- AC/DC power supply
- 360° rotate metal yoke, support universal head, baby pin

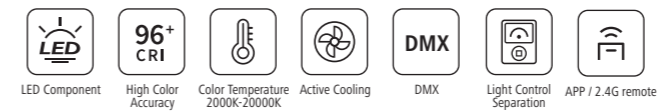
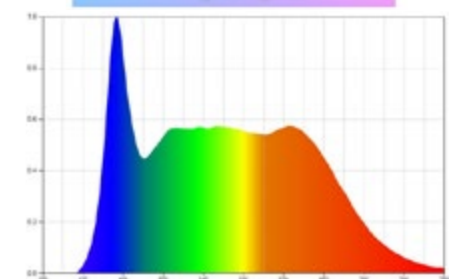
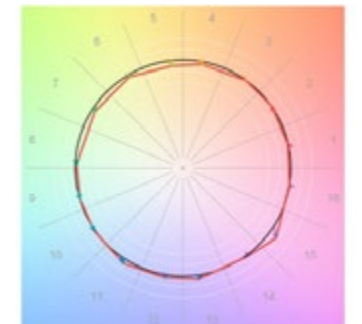

Product List

	Apollo 1200W	x1	Head cable (5m)	x1
	Control box	x1	Wire rope	x1
	Lighting clamp	x1	Rolling carrying case	x1
	Bowens protective cover	x1		
	Bowens hyper reflector	x1		
	AC power cable (5m)	x1		

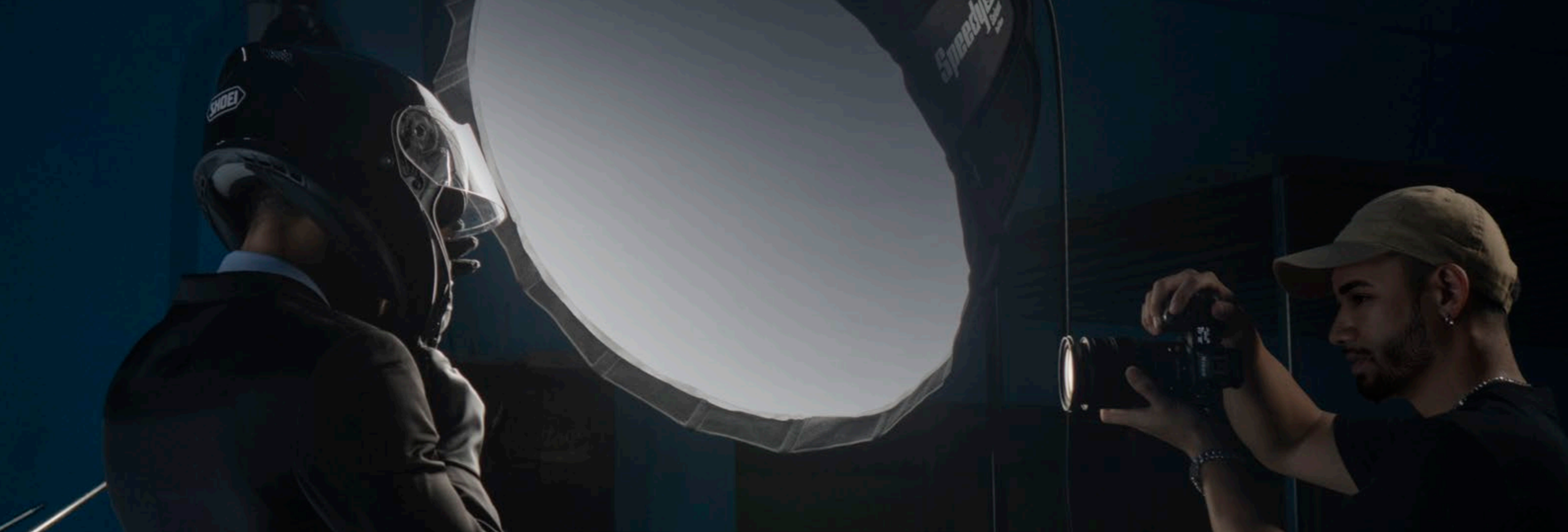

APOLLO COB Light Technical Parameters

Light	Apollo 100	Apollo 100X	Apollo 200	Apollo 200X	Apollo 300	Apollo 300X	Apollo 600 PRO	Apollo 600X PRO
Color temperature	5600K	2700K-6500K	5600K	2700K-6500K	5600K	2700K-6500K	5600K	2700K-6500K
100% illuminance (1M, No Accessories)	3980Lux	3320Lux	7250Lux	5000Lux	11660Lux	7060Lux	21600Lux	14200Lux
100% illuminance (1M, Hyper Reflector)	71500Lux	69400Lux	97000Lux	51400Lux	101000Lux	71500Lux	189000Lux	20800Lux
Power supply methods	AC/DC Power supply, V-Mount battery, F series battery buckle plate		AC/DC Power supply				AC/DC Power supply, V-Mount battery	
Color accuracy	CRI ≥ 96, TLCI ≥ 96						CRI ≥ 96, TLCI ≥ 96, Rf ≥ 94, Rg ≥ 100	
Control methods	On-Board, 2.4G remote, Selens Link App						DMX, Conetol Box, 2.4G remote, Selens Link App	
Lighting FX	8 (Explosion, TV, Pulsing, Faulty Bulb, Strobe, Lightning, Flashlight, Flame)							
Dimming	1%-100% (Liner, Exp, Logarithmic, S-Curve)							
Channel	54							
Group	6 (A~F)							
Operating temperature	-10°C~40°C							
Wireless operating range (2.4g remote)	≤50m							
Mute mode	√							
Cooling method	Active cooling							
Screen type	LCD							

APOLLO COB Lighting Accessories (Purchase separately)



APOLLO RGBACL Panel Lights



APOLLO

APOLLO 400W P400S RGBACL Panel Light SLC4-P400S

- Output Power: 400W
- Color temperature: 2000K-20000K
- Apollo P400S use Selens RGBACL six-color light engine provides more accurate colors
- CRI \geq 96, TLCI \geq 96, Rf \geq 94, Rg \geq 103 High Color Accuracy
- 4 independently adjustable pixels, use built-in lighting effects or via DMX control
- 4 Dimmer curves(Liner, Exp, Logarithmic, S-Curve)
- The front of the COB component is protected by glass
- Active cooling, working noise \leq 28dB
- 5 light control methods (On-Board, Art-Net, DMX, 2.4G remote, Selens Link App) support group control lighting
- Build in AC/DC power supply
- 360° rotate metal yoke, support universal head, baby pin

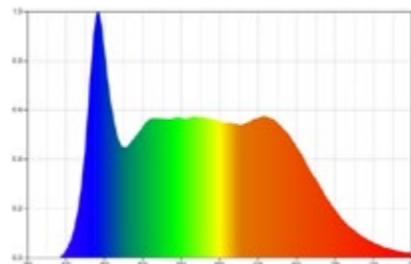
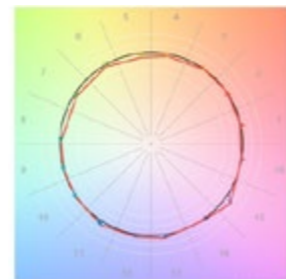

LED Component
 High Color Accuracy
 Color Temperature 2000K-20000K
 Active Cooling
 DMX
 Art-Net
 Light Control Separation
 APP / 2.4G remote

Selens link
 Download on the App Store
 Download for Android

APOLLO RGBACL Panel Lights



APOLLO

APOLLO 800W P800S RGBACL Panel Light SLC4-P800S

- Output Power: 800W
- Color temperature: 2000K-20000K
- Apollo P800S use Selens RGBACL six-color light engine provides more accurate colors
- CRI \geq 96, TLCI \geq 96, Rf \geq 94, Rg \geq 103 High Color Accuracy
- 4 independently adjustable pixels, use built-in lighting effects or via DMX control
- 4 Dimmer curves(Liner, Exp, Logarithmic, S-Curve)
- The front of the COB component is protected by glass
- Active cooling, working noise \leq 28dB
- 5 light control methods (On-Board, Art-Net, DMX, 2.4G remote, Selens Link App) support group control lighting
- Build in AC/DC power supply
- 360° rotate metal yoke, support universal head, baby pin

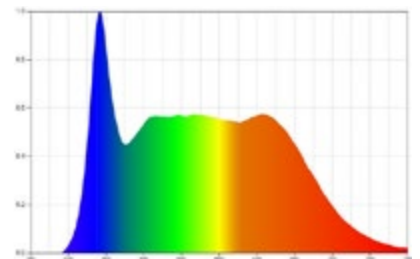
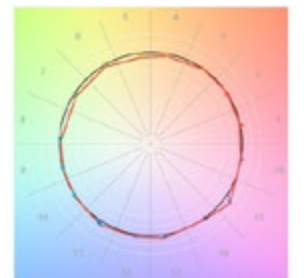

LED Component
 High Color Accuracy
 Color Temperature 2000K-20000K
 Active Cooling
 DMX
 Art-Net
 Light Control Separation
 APP / 2.4G remote

Selens link
 Download on the App Store
 Download for Android

Cinematic Spotlight Effect

LED Spotlight Series



Spotlight 100W / 200W / 300W

Spotlight uses electric focus, adjustable from 15°-60°. CRI ≥ 97, TLCI ≥ 97, high color accuracy.
360° rotate metal yoke, support universal head, baby pin



LED Spotlights



Spotlight 100W

SLC4-SP100



Spotlight 200W

SLC4-SP200



Spotlight 300W

SLC4-SP300

Flexible zoom

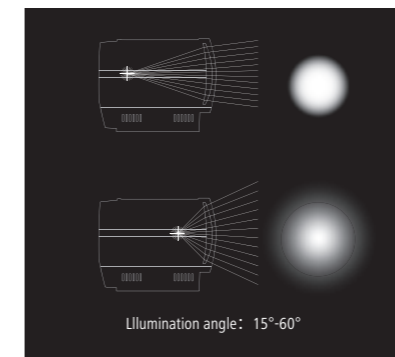

Product List (100W / 200W)



Product List (300W)



Light	Spotlight 100W	Spotlight 200W	Spotlight 300W
Powered by	AC power	AC power	AC power
Power	100W	200W	300W
Color temperature	5600K	5600K	5600K
100% illumination (Lux@1m)	≈23000 Lux	≈35000 Lux	≈131000 Lux
CRI	≥97	≥97	≥97
TLCI	≥97	≥97	≥97
Dimming range	0%-100%	0%-100%	0%-100%
Focusing method	Manual focus	Manual focus	Manual focus
Working temperature	-10°C-40°C	-10°C-40°C	-10°C-40°C
Heat dissipation method	Active cooling	Active cooling	Active cooling
Bare metal size	28x36x60cm	37x36x60cm	43x38x45cm
Bare metal net weight	8.5kg	9.5kg	9kg



FLEXI PANEL Flexible Fabric Lights



FLEXI PANEL

100W RGBWW LED Flexible Fabric Light

SLC4-FP100Spro

- Output Power: 100W
- Color temperature: 2500K-8000K
- Made of flexible light panels and fabric
- LS-100R use Selens RGBWW full-color light engine, have 36,000 colors available
- CRI \geq 95, TLCI \geq 98, Rf \geq 94, Rg \geq 103 High Color Accuracy
- 13 Lighting FX with 9 levels of adjustable effect speed
- 4 Dimmer curves(Liner, Exp, Logarithmic, S-Curve)
- 4 light control methods (DMX, control box, 2.4G remote, APP), support group control lighting
- 4 power supply methods(AC/DC power supply, V-Mount battery, F series battery buckle plate)
- A variety of soft light accessories, fixed with velcro
- 4 corners Magnetic design, adsorb to metal
- Multiple holes

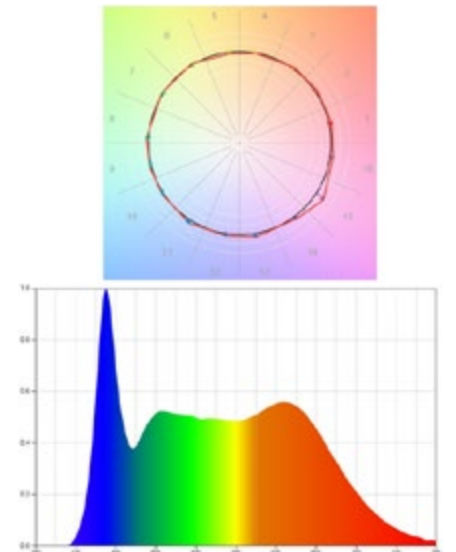
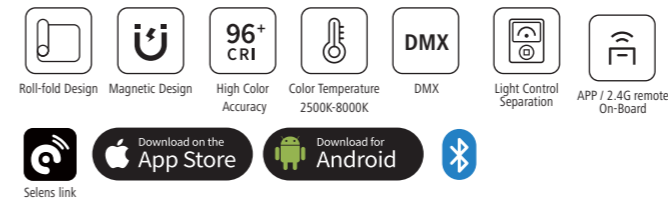

Light 100W RGBWW LED Flexible Fabric Light (LS-100R)

Lighting FX	13 (Explosion, TV, Pulsing, Faulty Bulb, Strobe, Lightning, Flashlight, Flame, Fireworks, RGB, Bar, Warning, Party)
Power supply methods	AC/DC Power supply, V-Mount battery, F series battery buckle plate
Output power	100W
Color temperature	2500-8000K
100% illumination	2150Lux (@0.3m)
Light effect mode	13
CRI	\geq 95
TLCI	\geq 98
Dimming range	0%-100%
Number of LED	144
Working temperature	-10°C~40°C
Expand size	about 31x58cm
Light weight	about 920g

Flexible Fabric Light Accessories



Skirt for FP100S Pro



Grip for FP100S Pro Softbox



Softbox 60*30 for FP100S Pro



Lantern for FP100S Pro

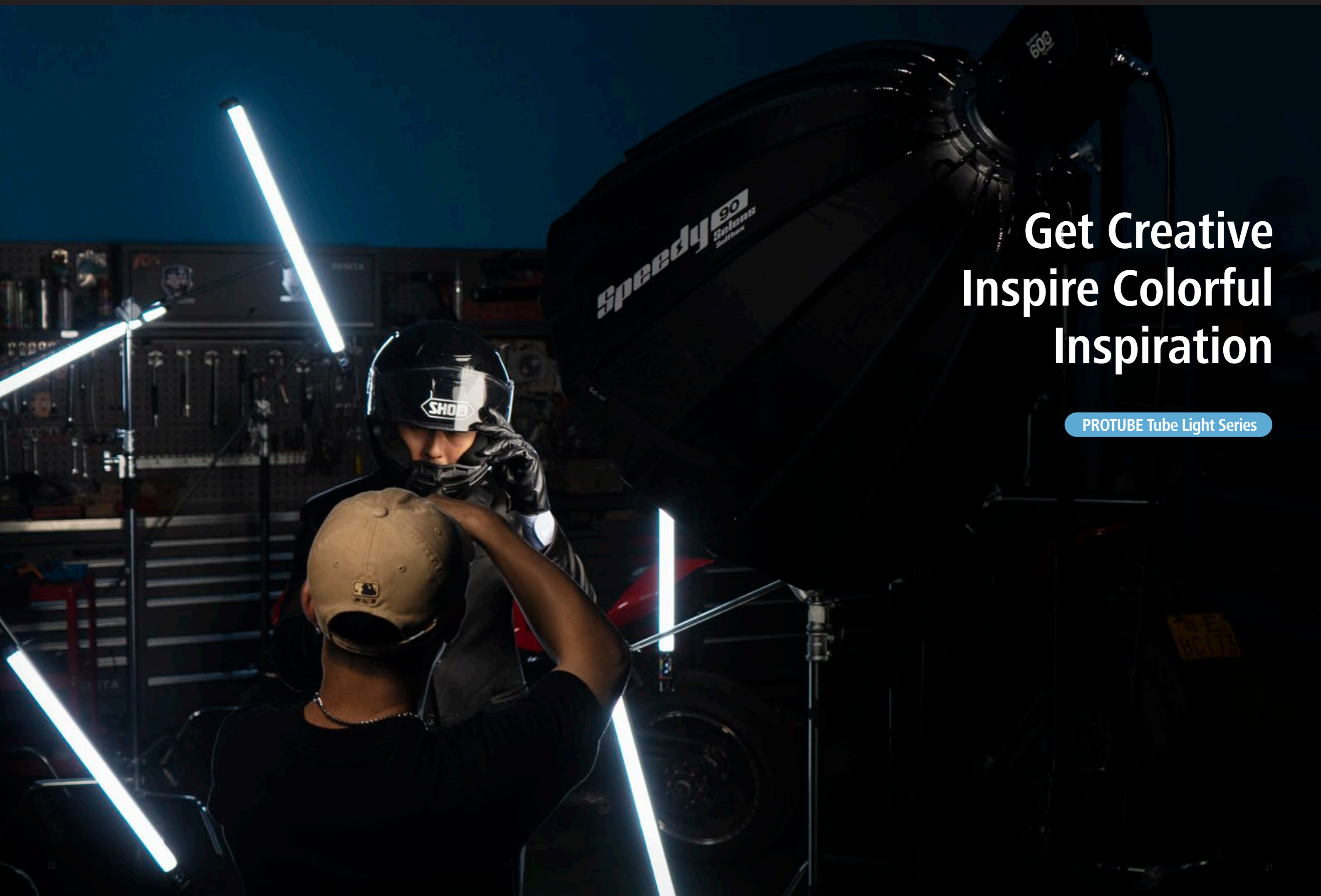

Get Creative Inspire Colorful Inspiration

PROTUBE Tube Light Series

PROTUBE Tube Lights

PROTUBE RGBWW Battery-Powered LED Tube

- Color temperature: 2500K-8000K
- Use Selens RGBWW full-color light engine, provide powerful color expression
- CRI \geq 96, TLCI \geq 96, High Color Accuracy
- 20 simulated light effects to simulate various light effect scenes
- Built-in lithium battery, Type-c charging
- Supports fast charging and charging while using
- 3 control methods: On-Board, DMX, Master-slave mode
- OLED display accurately presents parameters



Light	Protube 10	Protube 18	Protube 38
Battery powered	Lithium battery (2700mAh)	Lithium battery (9000mAh)	Lithium battery (18000mAh)
Power supply	Type-C 18W	Type-C 18W	Type-C 18W
Battery life	90min (100%brightness)	90min (100%brightness)	90min (100%brightness)
Output power	10W	18W	38W
Color temperature	2500K-8000K (\pm 200K)	2500K-8000K (\pm 200K)	2500K-8000K (\pm 200K)
Light effect mode	20 kinds	20 kinds	20 kinds
CRI	\geq 96	\geq 96	\geq 96
TLCI	\geq 96	\geq 96	\geq 96
Dimming range	0%-100%	0%-100%	0%-100%
Working temperature	-10°C~40°C	-10°C~40°C	-10°C~40°C
Bare metal size	ϕ 9x39cm	ϕ 9x64.5cm	ϕ 9x90cm
Bare metal net weight	0.66kg	0.9kg	1.2kg

LED Tube light DMX cable



Lightweight and compact Pocket travel

ALADDIN Pocket Light Series



ALADDIN Pocket Lights



AL Pocket Light

AL

- Weight 165g, easy to carry
- CRI \geq 95 High color accuracy
- 360° and crankshaft can be adjusted
- 270° for flexible rotation
- Built-in 2000 mAh lithium battery
- Use with magnetic diffuser, and color
- Color filters to create more
- different atmosphere



Magnetic diffuser and Color filters



AL-Pro Bi-color Pocket Light

AL-Pro

- Weight 178g, easy to carry
- CRI \geq 95 High color accuracy
- 360° and crankshaft can be adjusted 180° for
- Flexible rotation arm
- Built-in 1600mAh lithium battery
- Type-c port and support QC3.0 fast charging

Light	AL Pocket Light	AL-Pro Bi-color Pocket Light
Battery powered	Lithium battery (2000mAh)	Lithium battery (1600mAh)
Working power supply	3.7V	7.4V
Battery life	60min	60min
Output power	15W	12W
Color temperature	5500K	2500-9000K
100% illumination	3100Lux (@0.3m)	2800Lux (@0.3m)
	1090Lux (@0.5m)	1500Lux (@0.5m)
	395Lux (@1m)	320Lux (@1m)
CRI	\geq 95	\geq 95
TLCI	\geq 95	\geq 95
Dimming range	0%-100%	0%-100%
Number of LED	15	24 (Bi-color LED component)
Working temperature	-10°C~40°C	-10°C~40°C
Bare metal size	10.7x6.1x1.6cm	10.5x6.1x2.1cm
Bare metal net weight	0.165kg	0.178kg

ALADDIN Pocket Lights



AL-Pro RGB Pocket Light

AL-ProRGB

In HSI mode, RGB colors can be adjusted 360° at will, without a color filter. Turn the dial to change the colors, and use the saturation control to create various atmospheres and scenes.

- 0~100% stepless dimming, can smoothly adjust the light brightness.
- CRI \geq 96 High color accuracy.
- HSI adjustment range of 0-360°, adjustment of saturation, easy creation of various atmospheres and scenes.
- 20 lighting scene special effects modes.
- The multi-hole design of the 1/4 and 3/8 interfaces of the magnetic arm makes it easy to connect various pan-tilts and light stands.



AL-Max RGB Pocket Light

AL-Max

Light	AL-Pro RGB Pocket Light	AL-Max RGB Pocket Light
Battery powered	Lithium battery (1000mAh)	Lithium battery (3500mAh)
Working power supply	5V	5V
Battery life	90min	140min
Output power	7.5W	36W
Color temperature	2500-8000K	2500-7000K
100% illumination	2150Lux (@0.3m)	11200Lux (@0.3m)
Light effect mode	20	20
CRI	\geq 96	\geq 96
TLCI	\geq 96	\geq 96
Dimming range	0%-100%	0%-100%
Number of LED	25 (Bi-color + RGB LED component)	144 (Bi-color + RGB LED component)
Working temperature	-10°C~40°C	-10°C~40°C
Bare metal size	10.5x6x2.2cm	19.5x11x1.7cm
Bare metal net weight	0.188kg	0.49kg

Lighting Accessories



V-Mount Battery
6700mAh 99Wh
SBO5-V99



0.7kg 10x7.3x5.6cm
Dual D-TAP interface
Type-C 100W input and output power
BP/D-TAP 207W output power
DC power supply from 8V to 12V



V-Mount Battery
10500mAh 155Wh
SBO5-V155



0.96kg 10x7.3x7.7cm
Dual D-TAP interface
Type-C 100W input and output power
BP/D-TAP 207W output power
DC power supply from 8V to 12V



V-Mount Battery
14000mAh 207Wh
SBO5-V207



1.2kg 10x7.3x9.4cm
Dual D-TAP interface
Type-C 100W input and output power
BP/D-TAP 207W output power
DC power supply from 8V to 12V



2.4G Remote
R12



0.078kg 18x4.8x2.3cm
OLED screen, built-in 2.4G module,
wireless control distance reaches 50 meters



F-series Battery Plate
BP-NP-F



0.18kg 17x12x3cm
Suitable for Sony NP-F series batteries



DTAP to DC Cable (COB100W)
D-Tap-DC-50CM



0.07kg 16x9x4cm
Thick wire, metal aviation connector, stretchable
length 50cm

Lighting Accessories



Fresnel Bowens Mount
F20-B

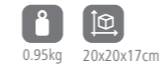

0.95kg 20x20x17cm
The outer shell is made of ABS material, and the
internal glass uses a Fresnel lens. It has an adjustable
zoom angle of 20°-40° and is compatible with lights
equipped with Bowens mount on the market

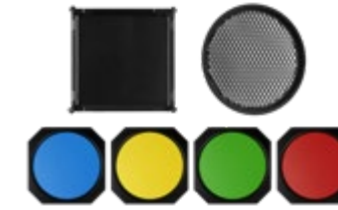

Barn Door, Color Insert and
Honeycomb Grid for Fresnel
F20-BD4

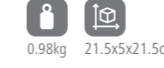

0.98kg 21.5x5x21.5cm
The barn door consists of 4 pieces and is made of
metal. Each piece of barn door can be adjusted
individually

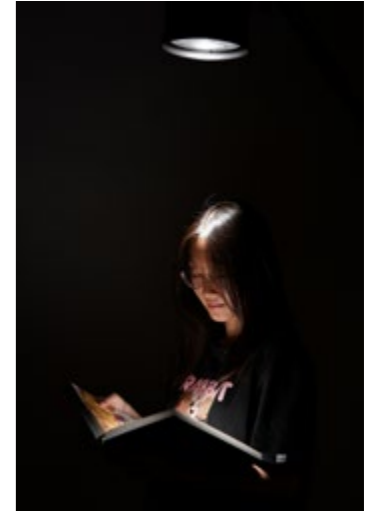

Spot Attachment
S-100

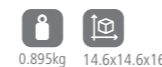

0.895kg 14.6x14.6x16.5cm



60mm Lens for S-100
CL-60

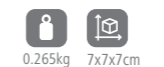

0.265kg 7x7x7cm

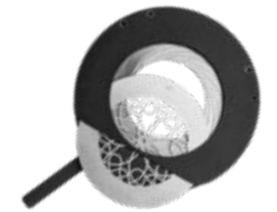

Iris Diaphragm for S-100
S-100-ID



0.09kg 13.5x10x0.4cm



Spot Attachment 21°
Bowens Mount
SA-21



2.9kg 41.5x23x20.5cm



Spot Attachment 40°
Bowens Mount
SA-40



2.9kg 41.5x23x20.5cm

Edge Parabolic Reflectors

Edge Parabolic Reflector parabolic reflective structure, adjust the zoom lever back and forth can change the distance between the light source and the reflective fabric, thereby changing the light effect and making the light soft and hard controllable.

The quick-open design is easy to use. In order to be compatible with a variety of lamps, we have developed Bowens, Broncolor, Profoto, and Godox mount, which supports multiple mount replacements, improves compatibility, support your imagination!

edge

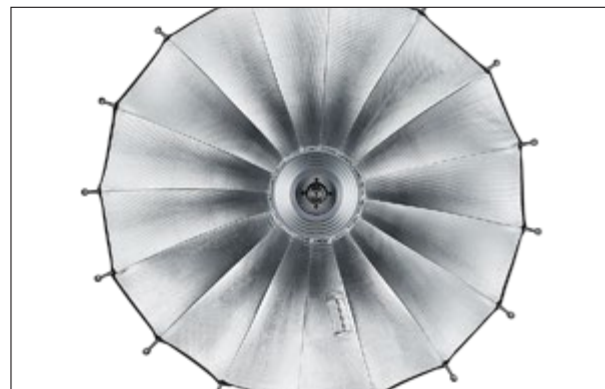
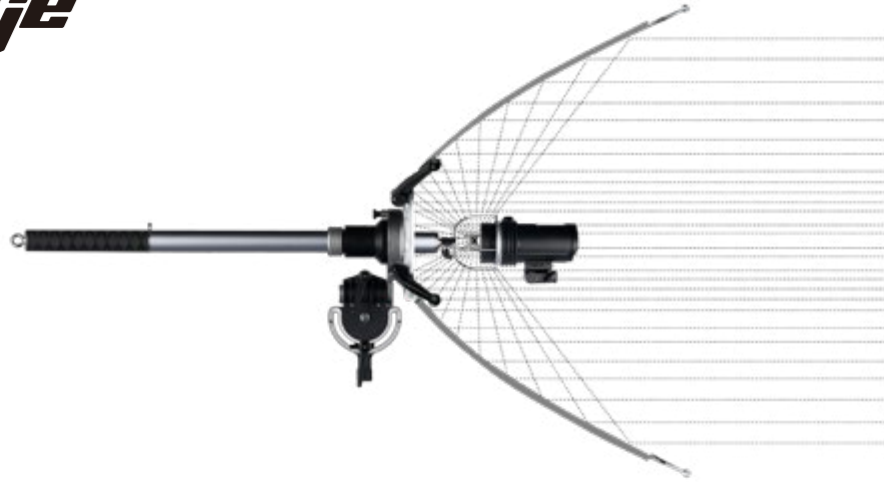

Edge Parabolic Reflectors



Edge Parabolic Reflector
(90cm)

SER90

Edge Parabolic Reflector
(120cm)

SER120

Edge Parabolic Reflector
(150cm)

SER150

Item	Diameter	Depth	Weight	Focusing Tube Length
SER90	90cm	57cm	6kg	107cm
SER120	120cm	78cm	6.5kg	107cm
SER150	150cm	90cm	7.1kg	107cm

Edge Parabolic Reflectors

Installation steps



1. Parabolic Reflector open and placed on the ground



2. Press the triggers diagonally at the same time



3. Install the focusing bracket

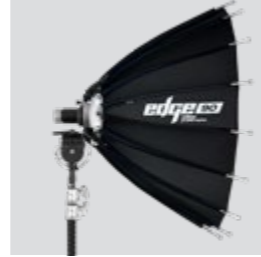

4. Install on light stand



5. Install the focusing tube then lock up

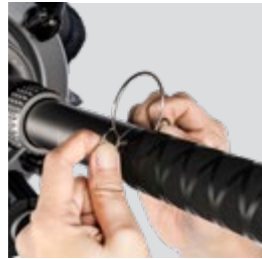

6. Install the safety snap ring

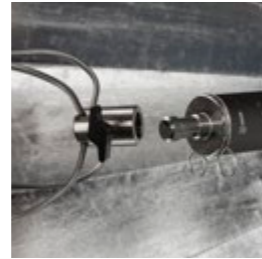

7. Install the light mount



8. Install light

Product List:

- Reflective umbrella x1
- Focusing bracket x1
- Focusing tube x1
- Safety snap ring x2
- Fixed buckle x1
- Sand bag x1
- Bowens mount x1
- Carrying bag x1
- Protective bag x1



Edge Parabolic Reflector Accessories



Edge Adapter for Profoto Lamps

SER-AD-P

0.53kg 14.3x14.3x19cm



Edge Adapter for Godox Lamps

SER-AD-G

0.38kg 14.3x14.3x13.5cm



Edge Adapter for Broncolor Lamps

SER-AD-BC

0.38kg 14.5x14.5x15.8cm



Edge Adapter for Bowens Lamps

SER-AD-B

0.38kg 14.4x14.4x16.7cm



Edge Reflex Disc

SER-RD216

0.41kg 21.7x21.7cm



Parabolic Reflector Focusing Bracket

SER-FD

2.03kg 23x23x26cm



Parabolic Reflector Focusing Tube

SER-FL120

Length: 120cm

Edge Parabolic Reflector Accessories



Edge Diffuser

SER-D90 Φ 90cm
SER-D120 Φ 120cm
SER-D150 Φ 150cm



Edge Soft White Diffuser

SER-S90 Φ 90cm
SER-S120 Φ 120cm
SER-S150 Φ 150cm



Edge Grid

SER-G90 Φ 90cm
SER-G120 Φ 120cm
SER-G150 Φ 150cm

Edge Grid

Directional light guide function, effective control of light.

Diffuser can make the light quality softer and reduce shadow contrast. Diffuser with different densities can be selected according to the needs of on-site shooting.





Softboxes

Softboxes have more sizes, accessory mounts, shapes, and quick-install models to choose.

Almost all soft boxes are equipped with double layers of soft light cloth, and some soft boxes are also equipped with three layers of soft light cloth to minimize light scattering. You can choose to use soft light cloth according to your needs to achieve different light effects.

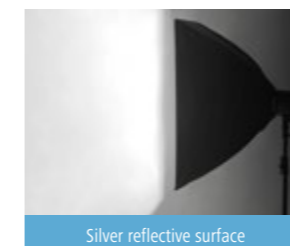
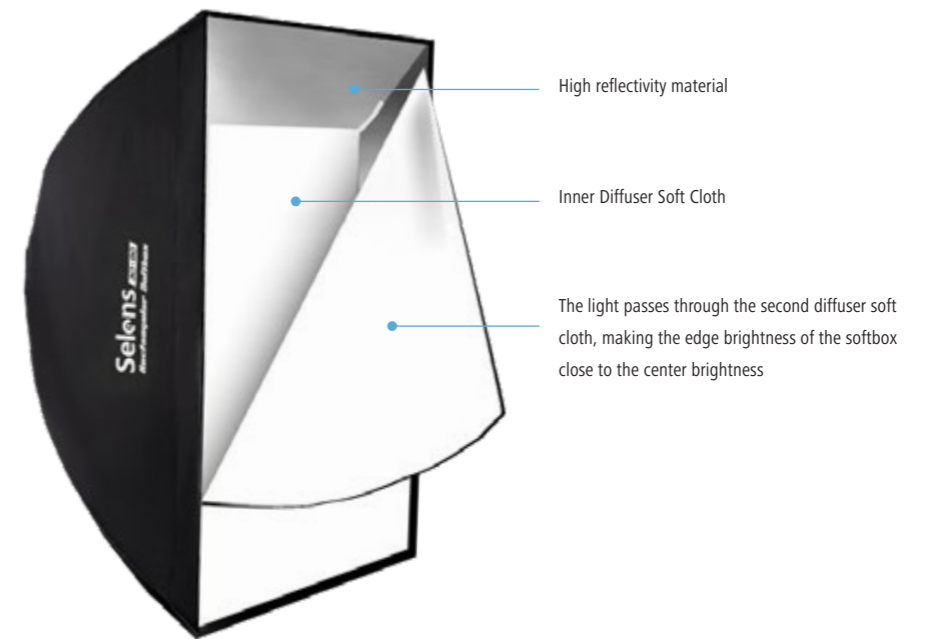

Silver reflective surface

The silver reflective surface has a high reflectivity and can be used as a large deep reflector. It has a large light ratio contrast and a strong three-dimensional effect.

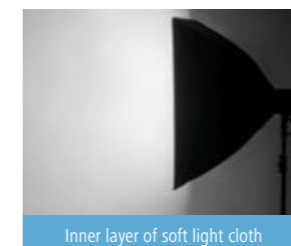

Inner layer of soft light cloth

The inner soft light cloth is located in the middle to eliminate or weaken the highlight points and make the light softer, but the edge contrast is larger.

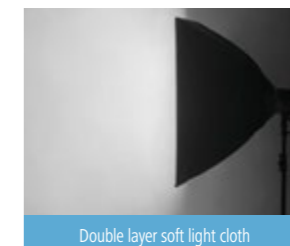

Double layer soft light cloth

The double-layer soft light cloth further softens the light, and the contrast between the middle and edge of the soft box is reduced to less than half a stop.

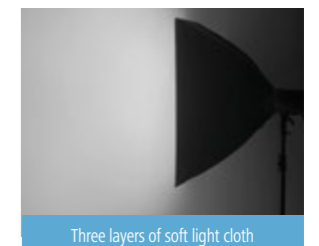

Three layers of soft light cloth

The double-layer soft light cloth further softens the light, and the contrast between the middle and edge of the soft box is reduced to less than half a stop.

Quick-Folding Softboxes

Softboxes are divided into standard softboxes and quick-folding softboxes. When using the quick-folding softbox, you can easily install and disassemble it by pulling and pressing, which is more convenient and time-saving.

Rectangle softboxes have a larger illumination area and are often used for portrait photography, still life photography, video live broadcasts and photography.

Strip softboxes are mostly used for shooting long-shaped products. They can gather the light into a long and slender highlight line, and are used to provide narrow strip-shaped highlight strips or outline for long products.



Quick-Folding Bowens Mount, install and disassemble it by pulling and pressing

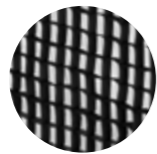

Optional Softbox Grid



Quick-Folding Bowens Mount, install and disassemble it by pulling and pressing

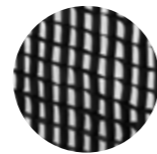

Optional Softbox Grid

Speedy

Quick-Folding Rectangular Softbox

Item	Size	Depth	Weight	Cloth quantity
SLS4-S60*90	60x90cm	50cm	1.85kg	Three layers
SLS4-S80*120	80x120cm	55cm	2.2kg	Three layers
SLS4-S120*180	120x180cm	77cm	1.85kg	Three layers

Speedy

Quick-Folding Strip Softbox

Item	Size	Depth	Weight	Cloth quantity
SLS4-S35*60	35x60cm	38cm	1.4kg	Double layers
SLS4-S30*90	30x90cm	44cm	1.6kg	Double layers
SLS4-S30*140	30x140cm	58cm	2.17kg	Three layers
SLS4-S40*200	40x200cm	89cm	2.8kg	Three layers

Quick-Folding Softboxes

Octagonal softboxes can create greater light effects than square softboxes, have a wider range of ambient light, and provide a wider range of lighting. They can illuminate the subject as well as the background.

Through the inner parabolic design of the circular softbox, the number of light reflections in the box is increased, which can produce clear shadows and uniform diffused light, making the shooting effect more three-dimensional. The circular softbox is easy to install and is suitable for outdoor shooting.



Quick-Folding Bowens Mount, install and disassemble it by pulling and pressing

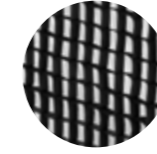

Optional Softbox Grid



Quick-Folding Bowens Mount, install and disassemble it by pulling and pressing

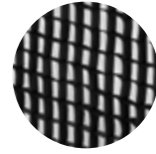

Optional Softbox Grid

Speedy

Quick-Folding Octagon Softbox

Item	Size	Depth	Weight	Cloth quantity
SLS4-S060	Φ62cm	40cm	0.9kg	Double layers
SLS4-S080	Φ82cm	38cm	1.0kg	Double layers
SLS4-S0100	Φ105cm	36cm	1.2kg	Double layers

Speedy

Quick-Folding Circular Softbox

Item	Size	Depth	Weight	Cloth quantity
SLS4-SC70	Φ70cm	69cm	2.42kg	Double layers
SLS4-SC90	Φ90cm	89cm	2.55kg	Double layers
SLS4-SC120	Φ120cm	96cm	3.2kg	Double layers

Softboxes



Optional Softbox Grid



Optional Softbox Grid

Rectangular Softbox

Item	Size	Depth	Weight	Cloth quantity
SLS4-60*90	60x90cm	50cm	1.85kg	Double layers
SLS4-80*120	80x120cm	55cm	2.3kg	Double layers

Strip Softbox

Item	Size	Depth	Weight	Cloth quantity
SLS4-35*60	35x60cm	38cm	1.5kg	Double layers
SLS4-30*90	30x90cm	44cm	1.5kg	Double layers
SLS4-30*140	30x140cm	58cm	2.3kg	Double layers
SLS4-40*200	40x200cm	89cm	3.0kg	Double layers

Softboxes

The deep parabolic design delivers light from a longer distance, making the light intensity decrease evenly from the center to the edge, making the layers richer and the light even and soft.



Optional Softbox Grid

Circular Softbox

Item	Size	Depth	Weight	Cloth quantity
SLS4-C70	Φ70cm	65cm	1.55kg	Double layers
SLS4-C90	Φ90cm	65cm	1.75kg	Double layers
SLS4-C120	Φ120cm	71cm	2.5kg	Double layers
SLS4-C150	Φ150cm	104cm	3.6kg	Double layers
SLS4-C190	Φ190cm	120cm	4.9kg	Double layers

The beauty box is specially used for outdoor shooting. It can create delicate and soft light, which is closer to a circle, soft eye light, and the light and shadow effect is more natural and beautiful.



Optional Softbox Grid

Beauty Box

Item	Size	Depth	Weight	Cloth quantity
SLS4-B65	Φ65cm	38cm	1.18kg	Double layers
SLS4-B85	Φ85cm	43cm	2.02kg	Double layers
SLS4-B120	Φ105cm	48cm	3.02kg	Double layers



Softbox Grids

Honeycomb mesh is Black's Material, which is composed of small squares. It can effectively control the light source to shine from the squares, control the direction of the light, and make the light more concentrated and reduce the impact on the background. If you want to further control the light, you can use it with a honeycomb network.

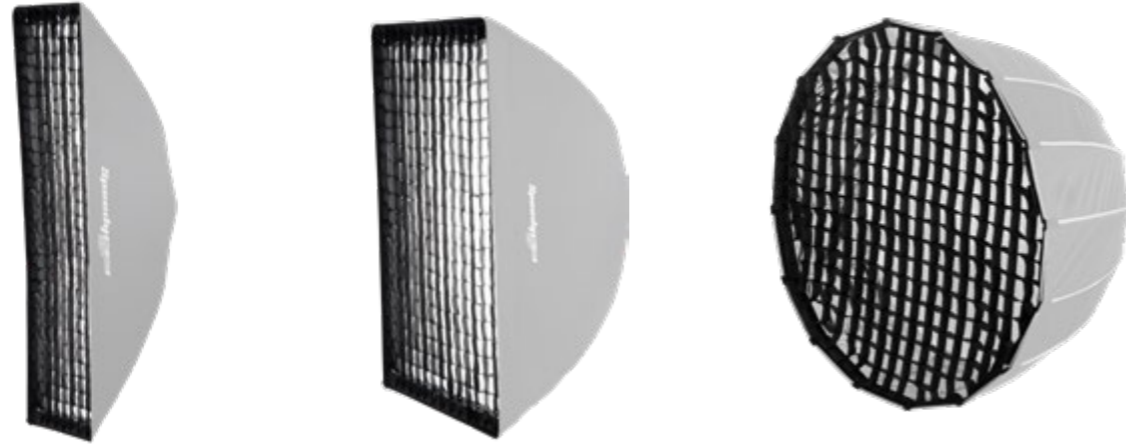

Strip Softbox Grid

Item	Size	Weight
SLS4-G35*60	35x60cm	0.09kg
SLS4-G30*90	30x90cm	0.11kg
SLS4-G30*140	30x140cm	0.15kg
SLS4-G40*200	40x200cm	0.11kg

Rectangular Softbox Grid

Item	Size	Weight
SLS4-G60*90	60x90cm	0.15kg
SLS4-G80*120	80x120cm	0.27kg
SLS4-G120*180	120x180cm	0.52kg

Circular Softbox Grid

Item	Size	Weight
SLS4-CG70	Φ70cm	0.13kg
SLS4-CG90	Φ90cm	0.32kg
SLS4-CG120	Φ120cm	0.57kg
SLS4-CG150	Φ150cm	0.90kg
SLS4-CG190	Φ190cm	1.30kg

Softboxes

Lantern Softbox

360° wide range of soft light, the soft light effect is comprehensive, the light starts from the center of the irradiation, and gradually weakens to the edges, with an obvious sense of layering. It is a commonly used soft light device for portrait shooting and video live broadcast, and can be used with high-power photography lights to create Space atmosphere with uniform and bright light.



Item	Size	Weight
SER-50	Φ50cm	1.35kg
SER-65	Φ65cm	1.45kg
SER-80	Φ80cm	1.65kg



Optional Accessories



Lantern Softbox Skirt

SER-50S Φ50cm

SER-65S Φ65cm

SER-80S Φ80cm

Space Light

In order to achieve better light control performance, it is equipped with removable bottom and side reflective curtains. At the same time, when used with a fixed clip, the length of the cylindrical diffuser can be changed, thereby changing the range, size and direction of the soft light, achieving flexible light control at different heights and angles. The soft light column can be freely retracted and is compact and easy to carry after folding.



Item	Size	Weight
SLS4-SL47	Φ47x70cm	0.285kg

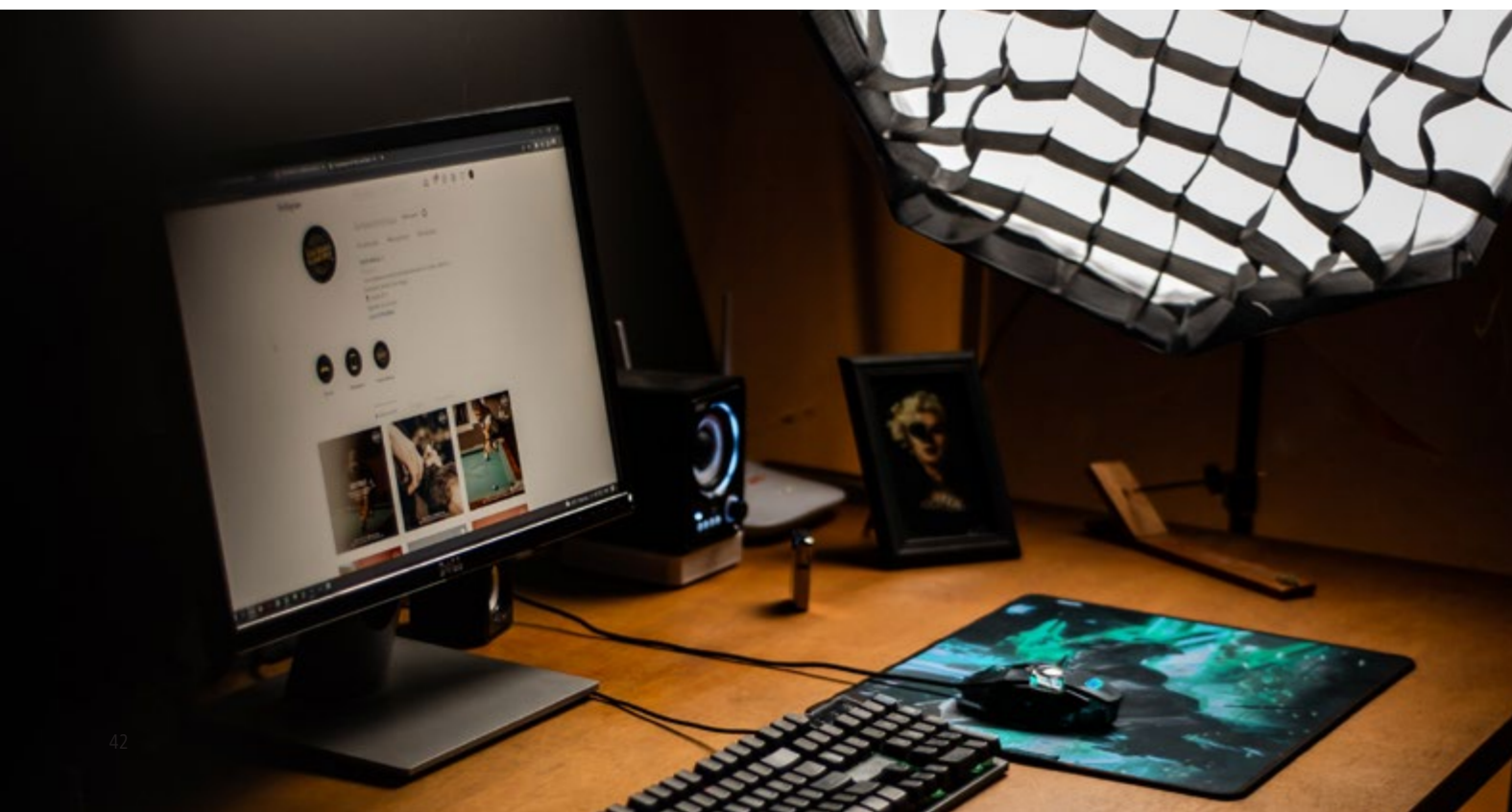

Softboxes

Circular Black Softbox

Circular black softbox has a black reflective surface inside. The black reflective surface can reduce hot spots and highlights and increasing outlines.



Item	Size	Weight
SLS4-CB70	Φ70cm	1.55kg
SLS4-CB100	Φ100cm	1.7kg

Octagon Bounce Softbox

The light is reflected by the top reflective surface and then scattered from the side diffuser soft cloth, emitting soft light evenly and expanding the irradiation range.

Use it with a diffuser skirt to reflect light that does not need reflection to the subject and improve light utilization.



Comes with Octagon Bounce Softbox Skirt

SLS4-OB110S

Item	Size	Weight
SLS4-OB50	Φ50cm	1.04kg
SLS4-OB70	Φ70cm	1.14kg
SLS4-OB90	Φ90cm	1.64kg

Softbox Mounts



Profoto Mount

SND137

0.50kg 17.1x17.1x6.3cm



Broncolor Mount

SLS4-SM-BC

0.42kg 17.1x17.1x4.4cm



Godox Mount

SLS4-SM-B

0.35kg 17.1x17.1x2.3cm

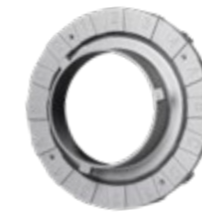

Bowens Mount

SLS4-SM-B

0.46kg 18.8x18.8x4.2cm



Profoto to Bowens Mount

SND135

0.44kg 14.5x14.5x10.5cm



Quick-Folding Bowens Mount

SLS4-QF-B

0.60kg 22x22x4.2cm



- Anti-corrosion and heat-resistant
- Convenient and stable
- Widely compatible





Compact Fold-Away Butterfly Frames

The compact fold-away butterfly frame is made of aluminum alloy and foldable for easy storage

Compared with the soft box, it has a larger light source area and can create a softer light effect, whether it is softening direct sunlight in outdoor shooting, or creating a soft shadowless light effect in the studio, soft light Screens have an irreplaceable role in controlling light.



304 stainless steel four corner supports



Folding card lock, easy to install

Item	Size	Weight
SLS4-BF15	150x150cm	8.1kg
SLS4-BF20	200x200cm	9.4kg
SLS4-BF24	240x240cm	10.5kg
SLS4-BF36	360x360cm	13.8kg

Product List



3 background cloths to choose, The green cloth, black cloth and grid.



the frame not include

Butterfly Frame Chroma Key Green Cloth

SLS4-BFC15	150x150cm
SLS4-BFC20	200x200cm
SLS4-BFC24	240x240cm
SLS4-BFC36	360x360cm



the frame not include

Butterfly Frame Black Cloth

SLS4-BFB15	150x150cm
SLS4-BFB20	200x200cm
SLS4-BFB24	240x240cm
SLS4-BFB36	360x360cm

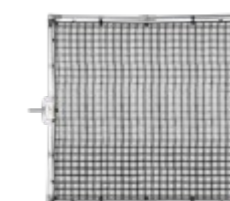

the frame not include

Butterfly Frame Grid

SLS4-BFG15	150x150cm
SLS4-BFG20	200x200cm
SLS4-BFG24	240x240cm
SLS4-BFG36	360x360cm

Flag & Frames

The flag is composed of a stainless steel flag frame and a flag cloth of a specific fabric. The flag board is light and strong, and has a good effect on softening or blocking light.



Gold, Silver, Black, Soft White Flag

Item	Size (Excluding handle)	Weight
SLF4-FB45*60	45x60cm	0.10kg
SLF4-FB60*75	60x75cm	0.14kg
SLF4-FB75*90	75x90cm	0.21kg

Four-color cloth is the four sides of a cloth cover
Made of professional fabric, does not fade, reflects light softly.

Soft White Flag

Item	Size (Excluding handle)	Weight
SLF4-FS45*60	45x60cm	0.06kg
SLF4-FS60*75	60x75cm	0.08kg
SLF4-FS75*90	75x90cm	0.10kg

Black Flag

Item	Size (Excluding handle)	Weight
SLF4-FC45*60	45x60cm	0.10kg
SLF4-FC60*75	60x75cm	0.15kg
SLF4-FC75*90	75x90cm	0.24kg



Stainless Steel Flag Frame

Item	Size (Excluding handle)	Weight
SLF4-F45*60	45x60cm	0.10kg
SLF4-F60*75	60x75cm	0.14kg
SLF4-F75*90	75x90cm	0.21kg

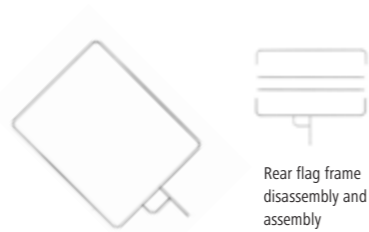

Magnetic Attraction Stainless Steel Flag Frame

Item	Size (Excluding handle)	Weight
SLF4-MF45*60	45x60cm	0.10kg
SLF4-MF60*75	60x75cm	0.14kg
SLF4-MF75*90	75x90cm	0.21kg

Magnetic adsorption, quick disassembly and assembly



Floppy Flag

Item	Size (Open Size)	Weight
SLF4-FF75*90	75x188cm	0.34kg

It can be folded and unfolded into multiple angles according to the usage scenario to shade, block, and weaken light.

Reflectors

Curved Reflector

Curved reflector uses arc-shaped structure and high reflectivity material, it can adjust the reflection at 90°.

Item	Size	Weight
SLR4-CR50*150	50x150 cm	2.13kg
SLR4-CR60*110	60x110 cm	2.29kg
SLR4-CR60*180	60x180 cm	2.65kg
SLR4-CR105*260	105x260 cm	3.72kg



Collapsible Reflector

Collapsible reflector uses an aluminum alloy frame and can be installed with different accessories to create different effects.

Item	Size	Weight
SLR4-SRS80*94	80x94cm	1.40kg
SLR4-SRS80*140	80x140cm	1.93kg



Umbrellas



Umbrella Deep Silver

Item	Size	Depth	Weight
SLR4-U41R	Φ105cm	37cm	0.85kg
SLR4-U51R	Φ130cm	47cm	1.10kg
SLR4-U65R	Φ165cm	58cm	1.30kg



Umbrella Deep Translucent

Item	Size	Depth	Weight
SLR4-U41T	Φ105cm	37cm	0.85kg
SLR4-U51T	Φ130cm	47cm	1.10kg
SLR4-U65T	Φ165cm	58cm	1.30kg



Umbrella Deep Diffuser

Item	Size	Weight
SLR4-U41R-S	Φ105cm	0.2kg
SLR4-U51R-S	Φ130cm	0.21kg
SLR4-U65R-S	Φ165cm	0.222kg



Umbrella Black Diffuser

Item	Size	Weight
SLR4-U41T-B	Φ105cm	0.28kg
SLR4-U51T-B	Φ130cm	0.35kg
SLR4-U65T-B	Φ165cm	0.462kg

Umbrellas



Octagonal Reflective Umbrella

Item	Size	Weight
SLR4-UBS33	Φ33" (Φ83cm)	0.165kg



Octagonal Reflective Umbrella

Item	Size	Weight
SLR4-UBG33	Φ33" (Φ83cm)	0.304kg



Umbrella Shallow Translucent

Item	Size	Weight
SLS4-US33	Φ33" (Φ83cm)	0.282kg
SLS4-US40	Φ40" (Φ101cm)	0.208kg







Octagonal Umbrella Softbox

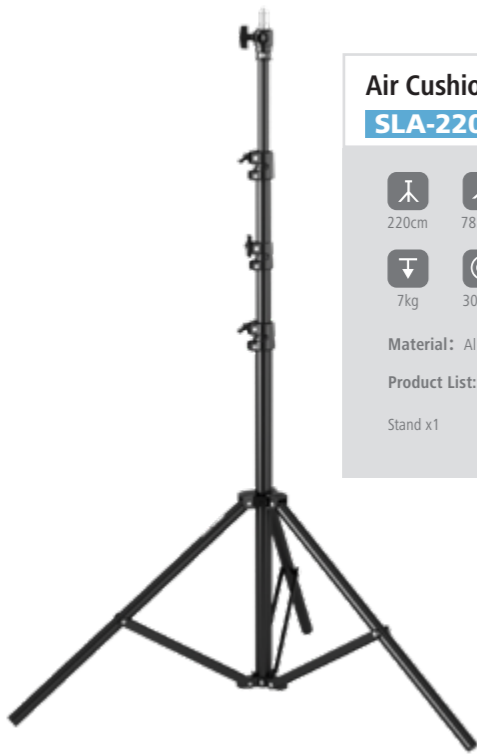

Item	Size	Weight
SLS4-UR33	Φ33" (Φ83cm)	0.509kg
SLS4-UR40	Φ40" (Φ101cm)	0.632kg

Air Cushion Stands



Air Cushion Stand (220cm)
SLA-2200

 220cm
  78.5cm
  1.5kg
  68cm

 7kg
  30 / 26 / 22 / 19mm





Material: Aluminum Alloy

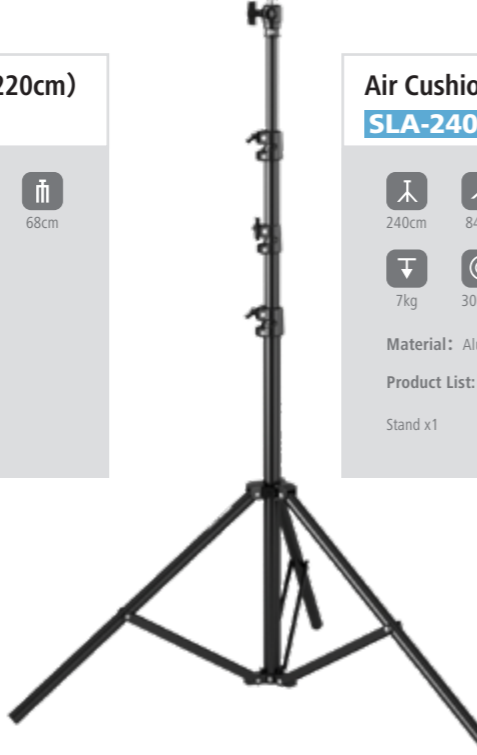

Product List:

Stand x1



Air Cushion Stand (240cm)
SLA-2400

 240cm
  84cm
  1.66kg
  77cm

 7kg
  30 / 26 / 22 / 19mm





Material: Aluminum Alloy



Product List:

Stand x1



Air Cushion Stand (260cm)
SLA-2600

 260cm
  106cm
  1.68kg
  94cm

 7kg
  30 / 26 / 22mm





Material: Aluminum Alloy

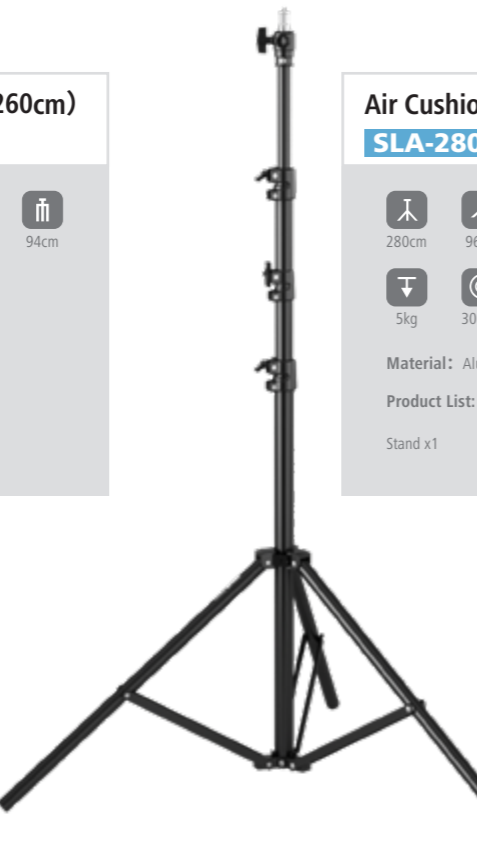

Product List:

Stand x1



Air Cushion Stand (280cm)
SLA-2800

 280cm
  96cm
  1.7kg
  104cm

 5kg
  30 / 26 / 22 / 19mm

Material: Aluminum Alloy

Product List:

Stand x1

Air Cushion Stands

Air Cushion Stand is made of aluminum alloy, and the air cushion buffer device can prevent the light pole from falling instantly if it is not locked.



Automatic buffering when the light stand is lowered to reduce damage to the light stand





Thickened support, stable support



Thickened tripod stand for reliable support

The head of the stand has cross perforations, and the baby pin can be installed horizontally or vertically



Air Cushion Stand (395cm)
SLA-3950

 395cm
  137cm
  2.4kg
  111cm

 7kg
  30 / 26 / 22 / 19mm





Material: Aluminum Alloy

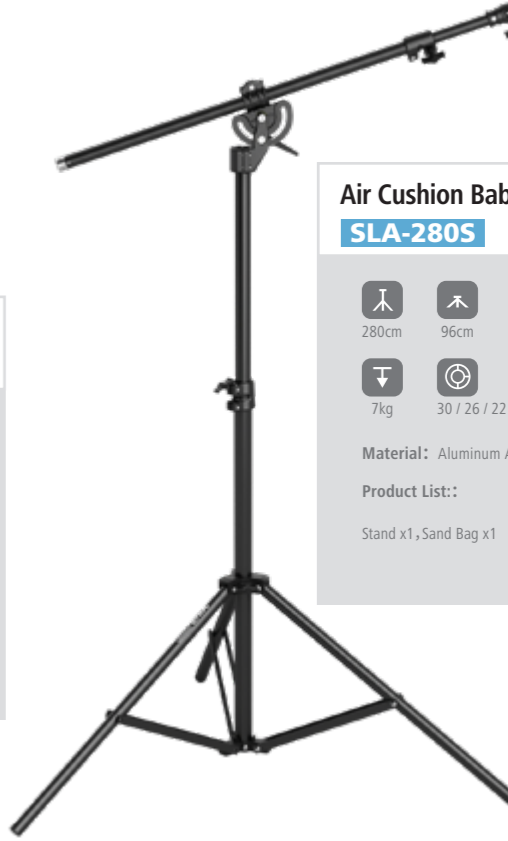

Product List:

Stand x1



Air Cushion Baby Boom Stand
SLA-280S

 280cm
  96cm
  2.2kg
  83.5cm

 7kg
  30 / 26 / 22 / 19mm

Material: Aluminum Alloy



Product List:

Stand x1, Sand Bag x1

Optional accessories



Aluminum Baby Boom
SBG210

 1.4kg
  Length: 80-200cm

Lightweight Stands

Carbon Fiber 2-in-1 Multi-Stand SLC-180

180cm	48cm	0.86kg	48cm
5.0kg	25 / 22 / 19 / 16mm		

Material: Carbon Fiber, Aluminum Alloy

Product List:

Stand x1, Stand bagx1



2-in-1 Multi-Stand FL-240

240cm	52cm	1.33kg	50cm
5.0kg	25 / 22 / 19 / 16 / 13mm		

Material: Iron

Product List:

Stand x1



Foldable Stand L-1700

169cm	55cm	1.15kg	55cm
3.0kg	29.5 / 26 / 22.4 / 19mm		

Material: Aluminum Alloy

Product List:

Stand x1



Foldable Stand L-2000A

185cm	48.5cm	0.98kg	48.5cm
2.5kg	25 / 22 / 19 / 16 / 13mm		

Material: Aluminum Alloy

Product List:

Stand x1



Stainless steel Lightweight Stand SLU-2200

220cm	78.5cm	1.9kg	68cm
5kg	30 / 26 / 22 / 19mm		

Material: Stainless steel

Product List:

Stand x1

Click Stands

Multiple light stands can be stored and connected to each other. Press the unlock button to quickly separate the light stands. There is also a shoulder strap hole design so that the light stand can be carried on the shoulder.



Align the grooves and insert to complete the connection locking



The stand can be quickly detached at the push of a button



Shoulder strap hole design, more convenient to carry

Click Stand (2.6m) MF702A

260cm	94.5cm	1.7kg	80.5cm
5kg	30 / 26 / 22 / 19mm		

Material: Stainless steel

Product List:

Stand x1

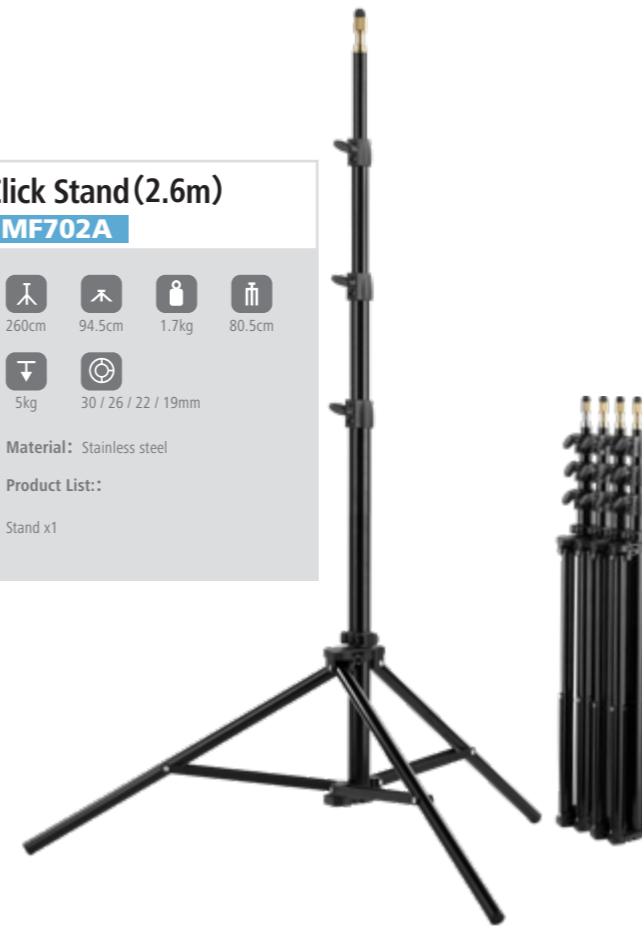

Click Stand (3.3m) MF702

330cm	94.5cm	1.9kg	80.5cm
5kg	30 / 26 / 22 / 19mm		

Material: Stainless steel

Product List:

Stand x1



Optional accessories



Click Stand Shoulder Belt

MF702SB

0.15kg	26x18x3.5cm

Roller Column Stands

Folding light stand with a low center of gravity and each support leg has a spring lock to quickly fold the light stand. One of the support legs is adjustable in angle to keep the light stand balanced on sloping or uneven terrain. Install removable casters to facilitate moving the light stand.



Wind-Up Roller Column Stand
MF689

35cm	35cm	4.6kg	54.5cm
30kg	35 / 30 / 25mm		

Material: Iron
Product List::
Stand x1, Allen wrench x1

Roller Stand
SW-6800

35cm	35cm	4.6kg	54.5cm
30kg	35 / 30 / 25mm		

Material: Iron
Product List::
Stand x1, Allen wrench x1



Hand crank design, effortless operation and high safety



Roller Column Stand
SW-6880B

220cm	131cm	6.7kg	121cm
10kg	35 / 30mm		

Material: Iron
Product List::
Stand x1, Allen wrench x1



Roller Column Stand
SW-6860

258cm	107cm	6.7kg	97cm
5.0kg	35 / 30 / 25mm		

Material: Iron
Product List::
Stand x1, Allen wrench x1



Roller Column Stand
SW-6870

340cm	111cm	7.8kg	100cm
5.0kg	35 / 30 / 25 / 20mm		

Material: Stainless steel
Product List::
Stand x1, Allen wrench x1

Roller Column Stands

Bearing capacity 15KG, multiple Sliding Arms can be installed on the main pole. Each Sliding Arm bears 5KG and supports 360° rotation to the left and right.

Optional accessories

Sliding Arm
MF6884

1.47kg	18x8x25cm

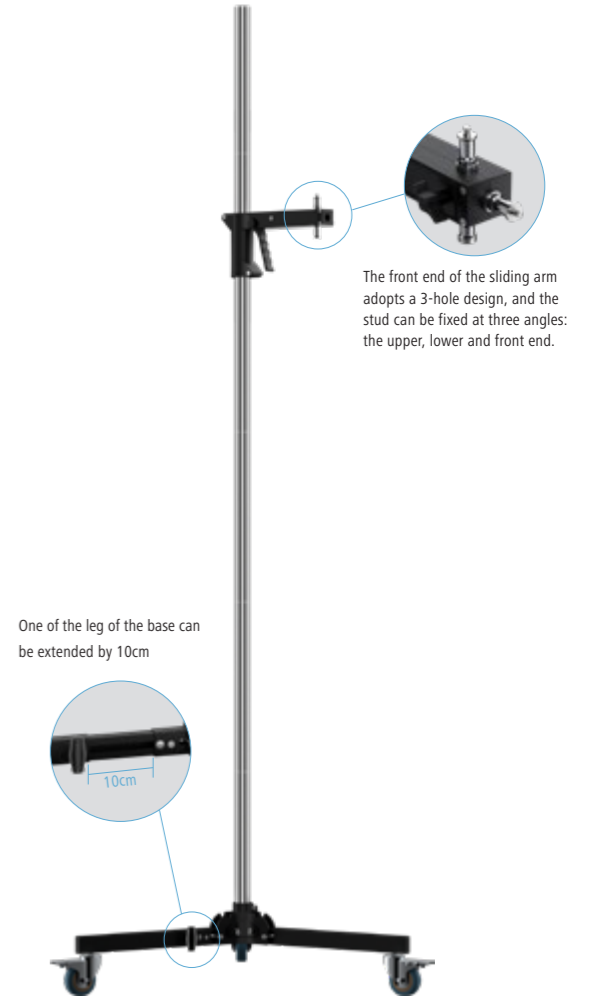

One of the leg of the base can be extended by 10cm

The front end of the sliding arm adopts a 3-hole design, and the stud can be fixed at three angles: the upper, lower and front end.

Roller Column Stand Include Sliding Arm
SLH4-S2100

220cm	115cm	7.6kg	110cm
15kg	35mm		

Material: Stainless steel
Product List::
Stand x1, Stand extension rod x1, Main rod connector x1, Sliding Arm x1, Allen wrench x1, Head adapter bracket x1, head adapter screw x1, Head adapter screw capx1, 1/4x3/8 Snap In Pins x1

Roller Column Stand Include Sliding Arm
SLH4-S2500

240cm	115cm	8.15kg	44cm
15kg	35mm		

Material: Aluminum Alloy+Stainless steel
Product List::
StandC-stand base(include a Main pole, 3个 wheels)x1, Sliding Arm x1, Stand extension rod x5, Allen wrench x1, 1/4和3/8 Snap In Pins x1

C-Stands



Foldable base



Folding feet, stable and non-shaking



Oversized knob with brass threaded bushing for durability



Buffer rubber ring to prevent hand pinching and protective equipment



Insert the main rod and lock the knob for easy installation



Support pads made of high-hardness POM material, wear-resistant

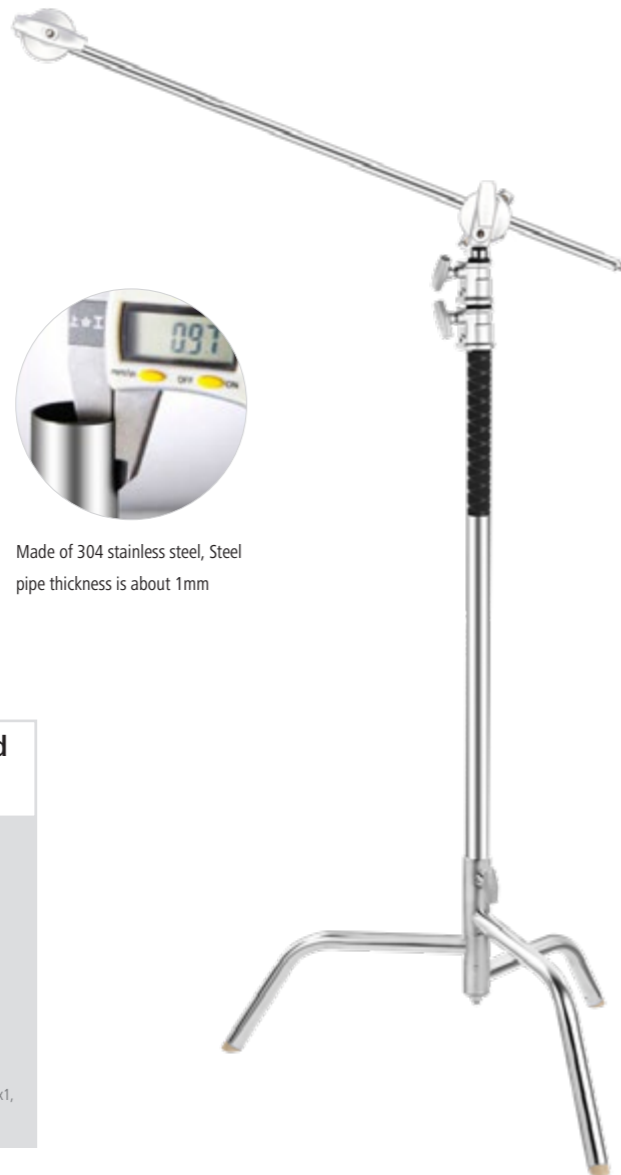

Made of 304 stainless steel, Steel pipe thickness is about 1mm

Stainless Steel 40" C-Stand

SLS136

295cm 136.5cm 8.5kg 136.5cm

40kg 35 / 30 / 25mm

Material: Stainless steel

Product List::

C-stand base x1, Main pole x1, Crossbar (100cm) x1, C-stand leg x1, rod clamp x2

C-Stands



Lift and rotate the leg

Spring ring locking system opens and closes base in 1 second

40" C-Stand

SLS136C-B ● Black
SLS136C-S ● Silver

295cm 130cm 8.7kg 130cm

30kg 35 / 30 / 25mm

Material: Iron

Product List::

C-stand base x1, Main pole x1, Crossbar (100cm)+Grip head x1, Grip head x1

Quick-Release 40" C-Stand

SLS136B-B ● Black
SLS136B-S ● Silver

305cm 140cm 8.9kg 136.5cm

30kg 35 / 30 / 25mm

Material: Iron

Product List::

C-stand base x1, Main pole x1, Crossbar (100cm)+Grip head x1



One of the legs can be height-adjusted by releasing the locking knob and sliding up or down the pole to keep the stand level on sloping or uneven terrain.

40" C-Stand Sliding Leg

- SLS136A-B** ● Black
- SLS136A-S** ● Silver

295cm	130cm	8.4kg	130cm
30kg	35 / 30 / 25mm		

Material: Iron

Product List:

C-stand base x1, Main pole x1, Crossbar (100cm)+
Grip head x1, Grip head x1



20" C-Stand

- SLS68C-B** ● Black
- SLS68C-S** ● Silver

140cm	79cm	6.7kg	79cm
30kg	35 / 30 / 25mm		

Material: Iron

Product List:

C-stand base x1, Main pole x1, Crossbar (50cm)+
Grip head x1, Grip head x1

40" C-Stand

- SLS136N-B** ● Black
- SLS136N-S** ● Silver

295cm	130cm	6.8kg	130cm
30kg	35 / 30 / 25mm		

Material: Iron

Product List:

C-stand base x1, Main pole x1, Grip head x1



Heavy Duty Stands

The stand is made of stainless steel and aluminum alloy. It has a large opening diameter and a low center of gravity. It can bear a load of up to 35kg and can be used for heavy-duty film and television lights. 3+1 load-bearing mode, the main pole stabilizes the center of gravity when landing, and the load-bearing is more stable. The telescopic legs can be freely adjusted according to shooting needs, and can adapt to uneven roads such as stairs. Equipped with universal wheels with foot brakes, it is convenient to move heavy equipment at any time and improve efficiency.

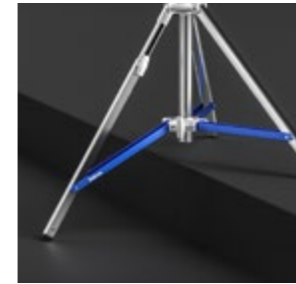

Telescopic legs adapt to various terrains



Aluminum alloy tripod thickened design



Main pole floor-standing design, more stable load-bearing



Universal wheels with foot brake, easy to move

The low-boy stand with low center of gravity includes the Baby Pin and Universal Head, with standard storage hook



16mm Baby Pin



Universal Head



Standard storage hook, compatible with light stand carts, easy to store

Heavy Duty Stands



Low-Boy Stand with Baby Pin

SLH4-HL1700

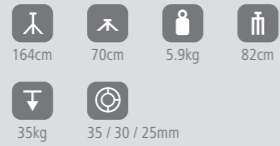

Material: Aluminum Alloy+Stainless steel

Product List::

Stand x1



Low-Boy Stand with Baby Pin

SLH4-HL1200

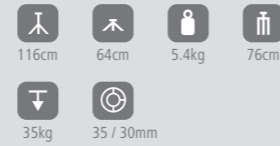

Material: Aluminum Alloy+Stainless steel

Product List::

Stand x1



Low-Boy Stand with Universal Head

SLH4-HL1700H

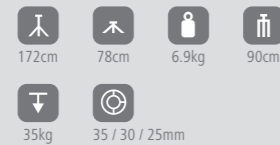

Material: Aluminum Alloy+Stainless steel

Product List::

Stand x1



Low-Boy Stand with Universal Head

SLH4-HL1200H

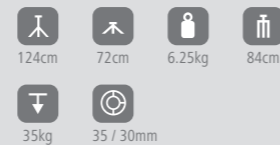

Material: Aluminum Alloy+Stainless steel

Product List::

Stand x1

Heavy Duty Stands

The stand is made of thickened stainless steel and aluminum alloy, which has strong load-bearing capacity and can be used for heavy-duty film and television lights. The central pole can be freely raised, lowered, disassembled and assembled according to shooting needs, allowing for flexible use. An extendable leg can meet different shooting locations and provide optimal support for the lamp.



Heavy Duty Stand

MYA-2200

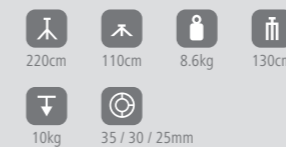

Material: Stainless steel

Product List::

Stand x1



Heavy Duty Stand

MYA-3000

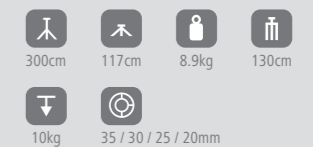

Material: Stainless steel

Product List::

Stand x1

Optional accessories



Wheels for Heavy Duty Stand

842874

Heavy Duty Stands

Made of steel, it is specially used to create high-angle light. It controls the lifting and lowering through a hand-operated drive gear. The automatic locking design and the double-lever anti-fallback design can prevent the main rod from falling unexpectedly.

28mm female base with 3 safety clasps. Telescopic support legs, horizontally adjustable, suitable for a variety of terrains.



Telescopic support legs, horizontally adjustable



The main pole is equipped with pedals for easy climbing



Thickened steel material



Removable handle for easy transportation and storage



Rubber wheels for easy movement



386cm
Maximum Height

Heavy Duty Wind-Up Stand with Braked Caster

C702

386cm	171cm	39kg	196cm
80kg	70 / 60 / 50mm		

Material: Chrome plated steel pipe

Product List: :

Stand x1

Heavy Duty Stands

Optional accessories



4.5" Grip Head

MF7012

27x24x9.8cm

Big Boom

MF6083

15kg Length: 160-280cm

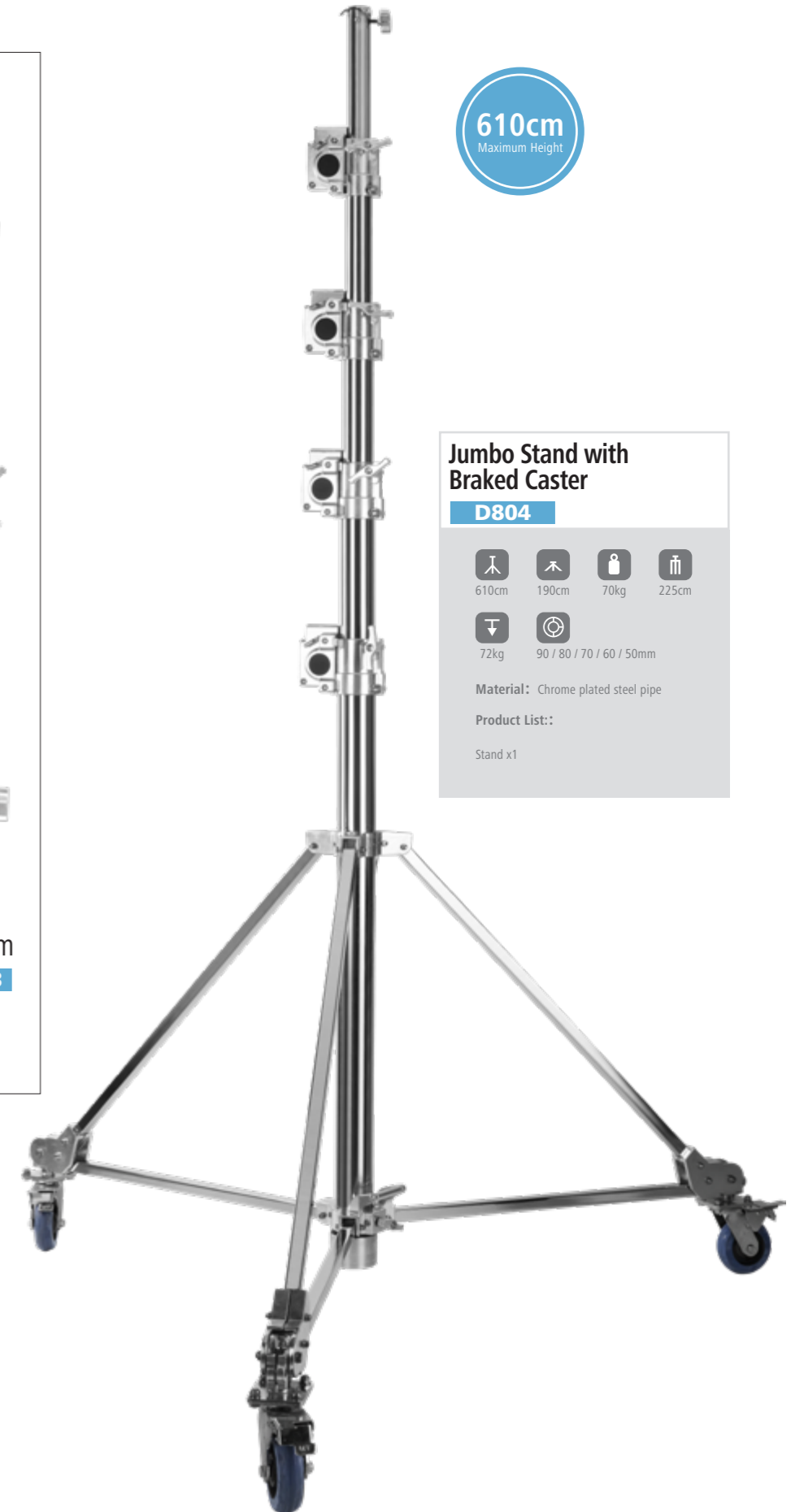

610cm
Maximum Height

Jumbo Stand with Braked Caster

D804

610cm	190cm	70kg	225cm
72kg	90 / 80 / 70 / 60 / 50mm		

Material: Chrome plated steel pipe

Product List: :

Stand x1

Backlight Stands

Each leg is equipped with a spring lock, which locks automatically after unfolding. The light stand can be quickly folded. The angle and level of the legs can be adjusted to adapt to different terrains.

All are equipped with removable casters, making moving the light stand easier



Small Roller Base

B4-20

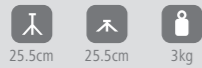

Material: Aluminum Alloy

Product List::

Stand x1, Allen wrench x1



Small Roller Base

B4-70

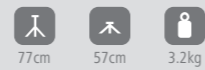

Material: Aluminum Alloy

Product List::

Stand x1, Allen wrench x1

Small Roller Base

B4-135



Material: Aluminum Alloy

Product List::

Stand x1, Allen wrench x1

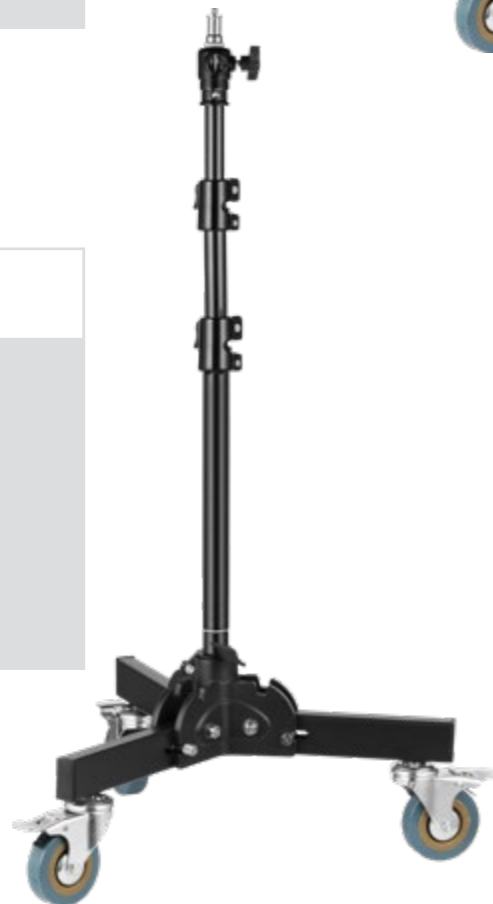

Backlight Stands

Lightweight, compact folding floor lamp stand. Small size makes it easy to store and carry.



Folding Base Mini Stand

L-100

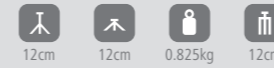

Material: Iron

Product List::

stand base x1, Stud x1

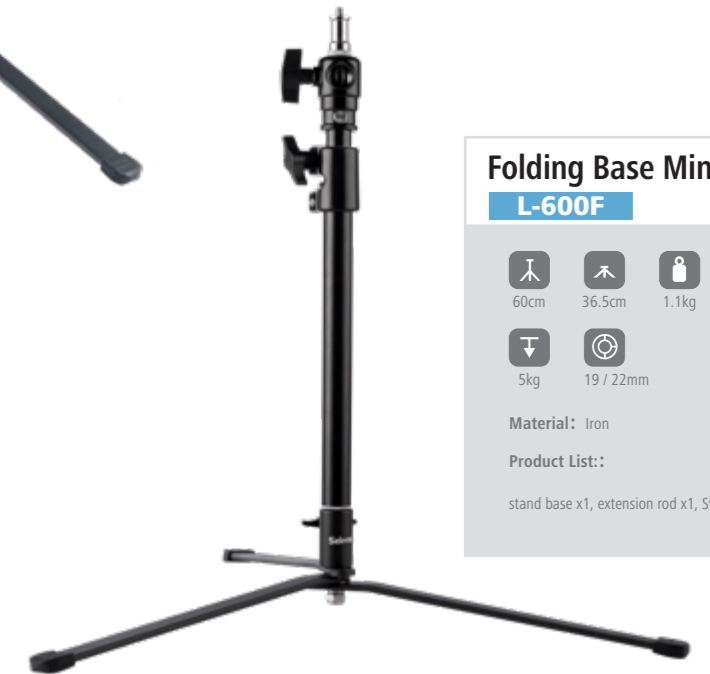

Folding Base Mini Stand

L-600F



Material: Iron

Product List::

stand base x1, extension rod x1, Stud x1

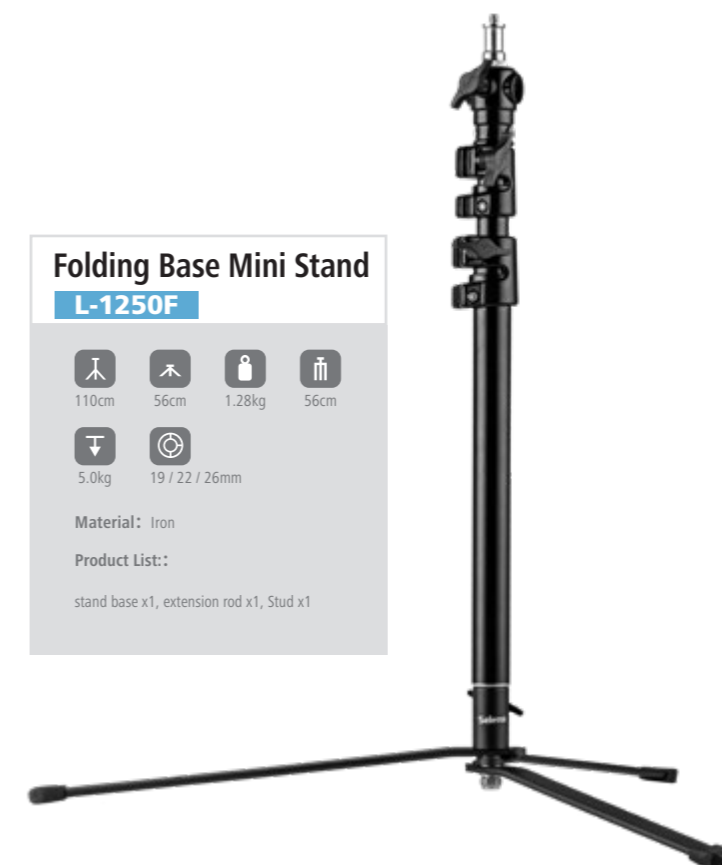

Folding Base Mini Stand

L-1250F

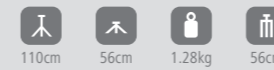

Material: Iron

Product List::

stand base x1, extension rod x1, Stud x1

Optional accessories



2 Sections Extension Rod

YCG-600



3 Sections Extension Rod

YCG-1250



Wall Booms



Wall Boom S1000

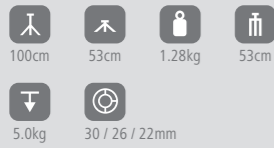

Material: Aluminum alloy pole

Product List:

Wall Boom x1, Expansion screw x4, Self-tapping screws x4



Wall Boom J1300

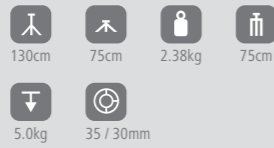

Material: Aluminum alloy pole

Product List:

Wall Boom x1, Expansion screw x4, Self-tapping screws x4



Wall Boom J1800

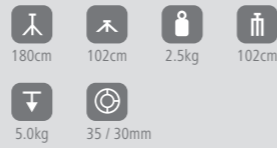

Material: Aluminum alloy pole

Product List:

Wall Boom x1, Expansion screw x4, Self-tapping screws x4

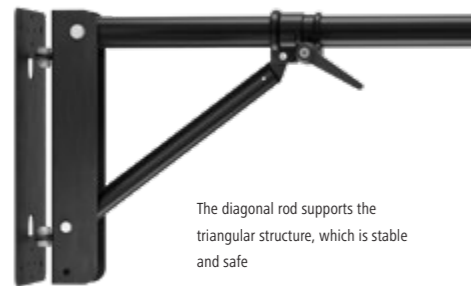

The diagonal rod supports the triangular structure, which is stable and safe

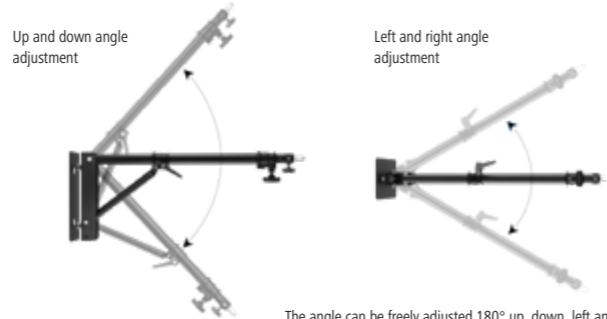

Up and down angle adjustment

Left and right angle adjustment

The angle can be freely adjusted 180° up, down, left and right



Strap Light Stand W4-86



0.335kg 17x12x8.3cm

Made of solid iron, can be fastened with bolts or straps and easily installed on various structures (such as columns or roof beams).

Product List:

Light stand x1, Straps x2, Screws x4



Wall Mount Booms

Aluminum alloy material, used for installing ceilings, walls, etc.



Wall Mount Boom L-250D

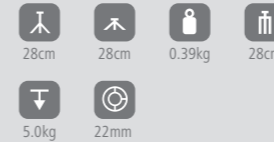

Material: Aluminum Alloy

Product List:

Light stand x1, screws x4



Wall Mount Boom L-600D

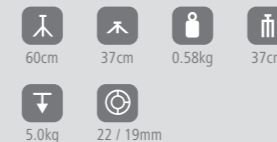

Material: Aluminum Alloy

Product List:

Light stand x1, screws x4



Wall Mount Boom L-1000D

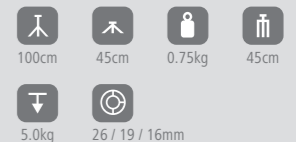

Material: Aluminum Alloy

Product List:

Light stand x1, screws x4

Baby Wall Plate



Made of solid iron, compact and portable, with ceiling-mounted design, no need to occupy floor space. Safety rope fixing ring to prevent the device from accidentally falling.

Product List: Light stand x1, screws x4



M11-027A

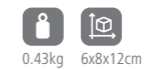

0.43kg 6x8x12cm

M11-027B

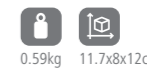

0.59kg 11.7x8x12cm

M11-027C



0.65kg 15.7x8x12cm

Super Viser Clamps



Super Viser Clamp

W035

Maximum opening: 70mm



Super Viser Clamp

W034

Maximum opening: 60mm



Super Viser Clamp

W036

Maximum opening: 200mm



Super Viser Clamp

W037

Maximum opening: 400mm

C-Stand Accessories



Mounting Adapter Baby Pin

SLS4-129

0.36kg 9.2x21.8x1.6cm

Steel material, chrome plated surface, durable and anti-corrosion. Various hole positions, strong expandability



Mounting Adapter

S4-176

0.27kg 17.6x9.2x0.3cm

Steel material, chrome plated surface, durable and anti-corrosion. Various hole positions, strong expandability



Microphone Boom Holder

MPH320

0.52kg 32x15.5x6cm

Steel material



C-Stand Accessories



(Set of 3)

Wheels

JL25

Suitable for 30mm pipe diameter

JL30

Suitable for 25mm pipe diameter

JL22

Suitable for 22mm pipe diameter



1.515kg 16x11x6.5cm



(Set of 3)

Wheels with Foot Brake

JL11-019



3.62kg 27x19x22cm



C-Stand Base

SLS136-CSB



3.1kg 27x50cm



C-Stand Wall Bracket

CJ360



4.11kg Upper bracket: 2.5x0.5x3.5cm
Lower bracket: 2.5x2.5x3.5cm

Can place 6 C-Stands

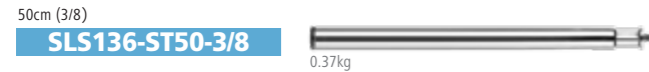

50cm (3/8)

SLS136-ST50-3/8

0.37kg

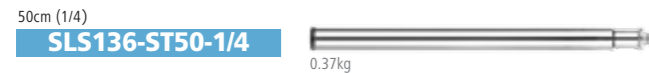

50cm (1/4)

SLS136-ST50-1/4

0.37kg

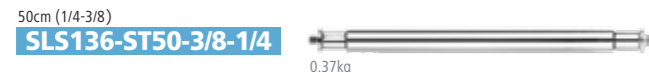

50cm (1/4-3/8)

SLS136-ST50-3/8-1/4

0.37kg



104cm (1/4)

SLS136-ST100-3/8

0.70kg



104cm (3/8)

SLS136-ST100-1/4

0.70kg



106cm (1/4-3/8)

SLS136-ST100-3/8-1/4

0.70kg



126cm (1/4-3/8)

SLS136-ST120-3/8-1/4

0.82kg

Grip Arms

Made of 304 stainless steel, corrosion-resistant and rust-resistant. 7 sizes, choose as needed, use with C-stand

C-Stand Accessories



Double Gag Grip Head

SLS136-033DB ● Black

SLS136-033DS ● Silver



1.165kg 8.6x9x24cm

Available in 4 aperture sizes:
3mm / 7mm / 12mm / 15mm



Stand Adapter 1-1/8" to 5/8"

SLS136-015



0.35kg 3.8x3.8x12.5cm

Paired with C-stand base, low-angle lighting can be achieved



Grip Head

SLS136-033B ● Black

SLS136-033S ● Silver



0.625kg 16x12.5x8cm

Available in 4 aperture sizes:
3mm / 7mm / 12mm / 15mm



(Set of 3)

Stand Leg Protector Set

SLS-LP3



0.024kg 3.5x3.5x7cm

Applicable light stand leg diameter 25-45mm



Complimentary sandbag

Steel Baby Boom

SLL4-2200



3.2kg Length: 125-220cm

Made of stainless steel, durable. The extension rod can be extended to 2.2 meters



Super Clamps

The Super Clamp is equipped with two M5 interfaces and a 1/4 interface, which is suitable for a variety of devices. It can be installed on the round tube of a light stand or tripod to expand more equipment. It can clamp round tubes and square objects, with great flexibility and adjustability.



Super Clamp M11-034

0.563kg 15kg 54x145x91mm

Material: Main body aluminum alloy

Product List:

Super Clampx1, Anti-slip mat x1, Stud x1



Clamping round tube
(Clamping diameter: 13-55mm)

clamping plane
(maximum thickness: 30mm)

The gasket snaps into the V-shaped groove for more stable clamping

Optional Accessories



Square Mounting Plate

C4-NP01



U-Hooks

C4-JH10



Offset Arm

C4-OA25



Hex Baby Stud

C4-SP01



5/8" Snap In Pin

C4-BP120



Round Stud 3/8"-16F
& 1/4"-20F

C4-002



Round Stud 3/8"-16M
& 1/4"-20M

C4-002A



Hex Stud 3/8"-16F &
1/4"-20F

C4-003



Hex Stud 3/8"-16M to
1/4"-20M

C4-004



Hex Baby Stud
1/4"-20

C4-005



Hex Baby Stud 3/8"-16

C4-006



Snap In Pins

C4-008

Studio Accessories



Foamcore Fork with 5/8" Pin

SE-030

0.30kg 20x8cm



Foamcore Fork with 5/8" Pin

SE-030A

0.34kg 36x24.5cm



Foamcore Fork with 5/8" Pin

SE-248

0.73kg 25x29.3cm

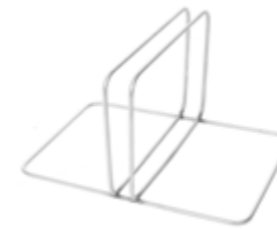

Studio Foamcore Bracket

SE-455

4.5kg 55x45x31cm

Can be used for 4.5cm-5cm thick foam board



Filler not included

Sand Bag S

SE-032

0.4kg 13x42cm

Can be hung on the light stand or placed at the bottom of the light stand to prevent the light stand from collapsing



Filler not included

Shot Bag M

SE-025

0.133kg 66x15cm

Thickened fabric, large opening on the side, convenient for filling materials, can hold 2.5kg



Filler not included

Shot Bag L

SE-050

0.192kg 76x20cm

Thickened fabric, large opening on the side, convenient for filling materials, can hold 5kg

Background Supports

Background Support Kit

Made of aluminum alloy, black paint process, adjustable width and height.

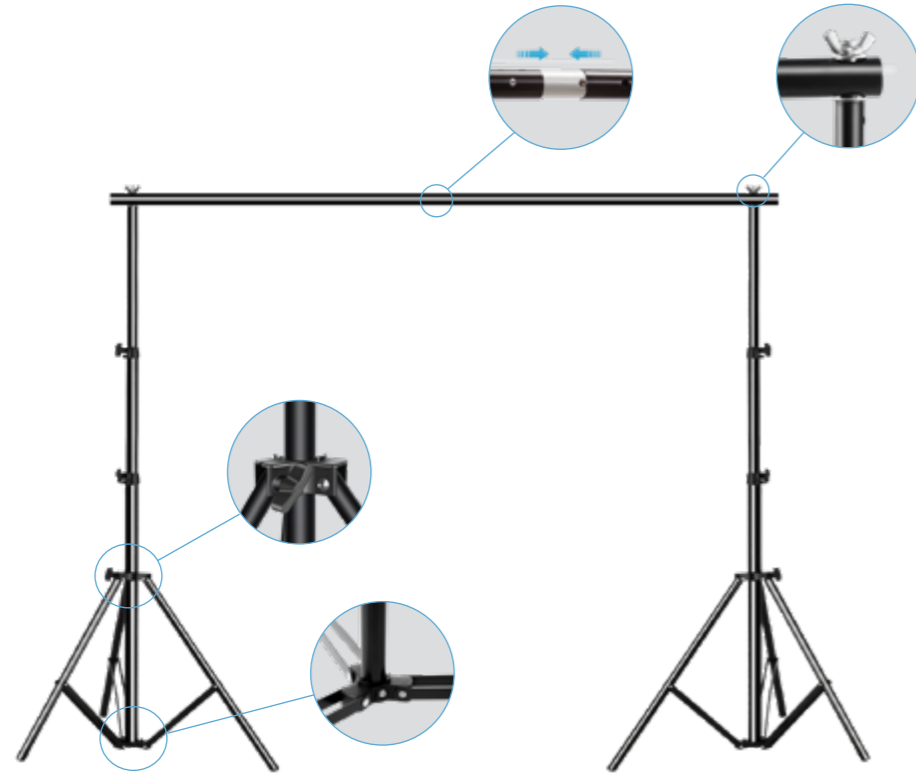

Optional accessories



Metal A-Clamps

SBB-715

0.104g 7.7x10.4x6.6cm

Item	Size	Weight	Load Bearing
SBB-BS-2*2	200 x 200 cm	3.0 kg	5kg
SBB-BS-2*3	200 x 300 cm	2.45 kg	5kg
SBB-BS-2.6*3	260 x 300 cm	3.59 kg	5kg
SBB-BS-2.8*3	280 x 300 cm	4.50 kg	5kg
SBB-BS-3*3	300 x 300 cm	4.50 kg	5kg

Magnetic Background Support

Item	Size	Weight	Load Bearing
MBT350	36.5x10.5x8.5cm	0.57kg	2.5kg

N52 specification magnet, strong magnetic force, can easily and quickly install the background board on the light stand. Can fix 200cm wide reflector or background.



Chroma Key Backgrounds

The chroma key backgrounds has a green or blue screen to choose from, making it a choice for live streaming and movie production. Usually used for live streaming, movie shooting, etc



Collapsible Chromakey Background

Made of cotton, opaque and non-reflective. The folded size is 1/6 of the background.

Color	Size	1.0x1.5m	1.5x2.0m
● Green / ● Blue		SFC-DCB-100*150-BG	SFC-DCB-150*200-BG
● Blue / ● Grey		SFC-DCB-100*150-BR	SFC-DCB-150*200-BR
● Green / ● Grey		SFC-DCB-100*150-RG	SFC-DCB-150*200-RG
● Black / ○ White		SFC-DCB-100*150-BW	SFC-DCB-150*200-BW

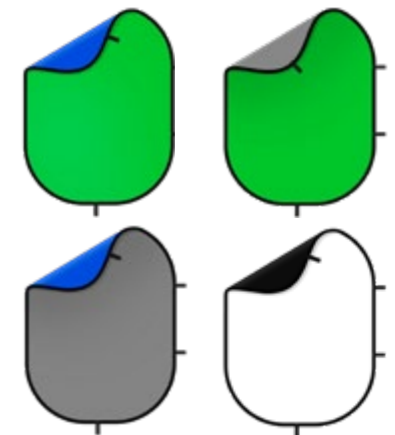

Chroma Key Backgrounds

Chromakey Background Cloth

Made of polyester material, opaque and non reflective, foldable. Large size, can be used for photography, post production special effects in movies, etc.

Color	Size	2x3m	3x3m	3x6m
● Green / ● Blue		SFC-DB-2*3-BG	SFC-DB-3*3-BG	SFC-DB-3*6-BG
● Blue / ● Grey		SFC-DB-2*3-BR	SFC-DB-3*3-BR	SFC-DB-3*6-BR
● Black / ○ White		SFC-DB-2*3-BW	SFC-DB-3*3-BW	SFC-DB-3*6-BW
● Green / ● Grey		SFC-DB-2*3-RG	SFC-DB-3*3-RG	SFC-DB-3*6-RG

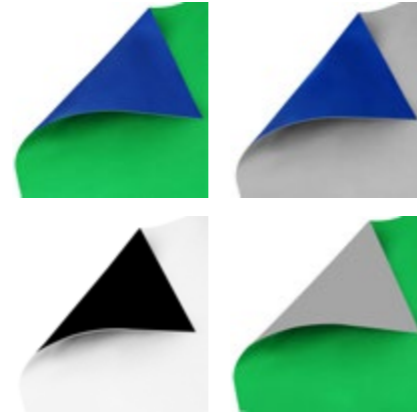

Chromakey Background Cloth Hook Type

Color	Item	Size
● Green / ● Grey	SFC-DBH-150*200-RG	150 x 200 cm
● Green / ● Blue	SFC-DBH-150*200-BG	150 x 200 cm



Chromakey Floor

Made of vinyl plastic, it has high strength, fire resistance, pressure resistance, and wear resistance, is environmentally friendly, odorless, and easy to clean. The width of floor glue is 1.6m, and the length can be customized.

Color	Item	Size
● Green / ● Blue	SFC-CF-1.6-BG	Width 1.6m, length can be customized

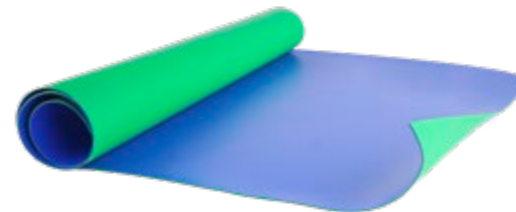

Chroma Key Backgrounds

Collapsible Chromakey Background Chair Type

This is a background board that can be directly installed on a chair. It can quickly arrange scenes. The strap can be directly hung on the bracket.

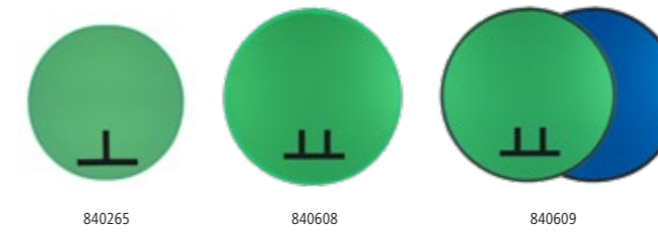

Color	Item	Size
● Green	SFC-DCBF-150*200-G	Ø 130 cm
● Green	SFC-DCB-150-BG	Ø 150 cm
● Green / ● Blue	SFC-DCB-130-G	Ø 150 cm



Collapsible Chromakey Background with Floor

It can easily realize full-body keying and can be used for film and television special effects, studio photography, clothing live broadcast, dance teaching, fitness teaching, etc.

Color	Item	Size
● Green	SFC-DCB-150-G	Ø 150 x (200+200) cm



Screen Suits

Screen Suit

There are two types of screen suit: jumpsuits and two-piece, with uniform colors and no wrinkles. Invisible zippers are used for easy post-processing. It is made of elastic polyester material.

Commonly used for filming special effects in movies and television.

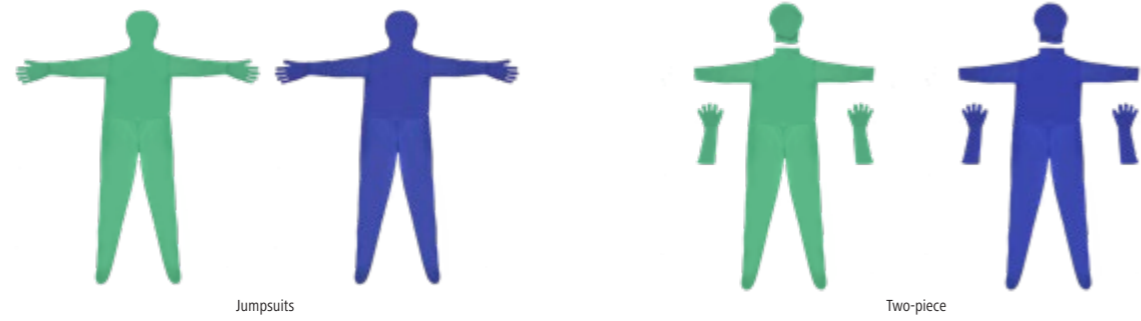

Color	Size	M (150cm)	L (160cm)	XL (170cm)	XXL (180cm)
● Jumpsuits-Green		SPK6-S-G-M	SPK6-S-G-L	SPK6-S-G-XL	SPK6-S-G-XXL
● Jumpsuits-Royal Blue		SPK6-S-B-M	SPK6-S-B-L	SPK6-S-B-XL	SPK6-S-B-XXL
● Two-piece-Green	-		SPK6-ST-G-L	SPK6-ST-G-XL	SPK6-ST-G-XXL
● Two-piece-Royal Blue	-		SPK6-ST-B-L	SPK6-ST-B-XL	SPK6-ST-B-XXL

Screen Gloves

Color	Size	One size fits all
● Green		SPK6-SG-G
● Royal Blue		SPK6-SG-G



Collapsible Pattern Backgrounds

Different patterns on the front and back sides are called double-sided background boards. Foldable, practical and easy to carry. Can be used as live broadcast background, still life and portrait shooting, etc.

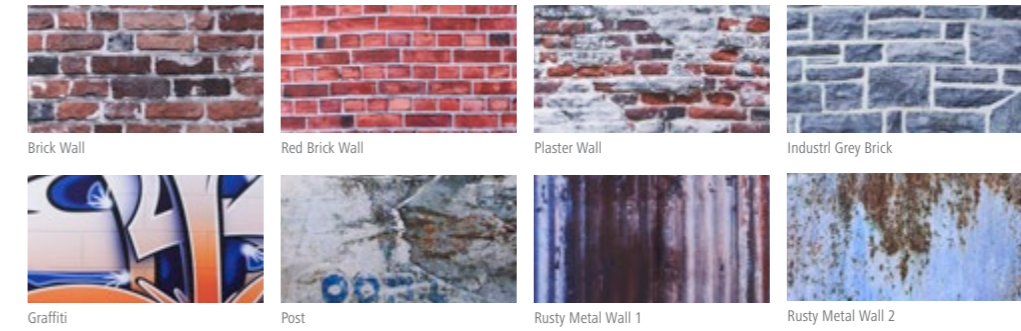

Color	Size	1.5x2m (Oval)
Brick Wall / Red Brick Wall		SFC-DCB-150*200-RB
Plaster Wall / Industri Grey Brick		SFC-DCB-150*200-PI
Graffiti / Post		SFC-DCB-150*200-PG
Rusty Metal Wall 1 / Rusty Metal Wall 2		SFC-DCB-150*200-RR



Company : Guangzhou Selens Information Network Technology Co., Ltd.

TEL : +86 20 83802251

Email : marketing@selens.com

www.selens.com



Instagram



Facebook



WeChat



Bilibili