

All-in-one solar charge Inverter

User Manual

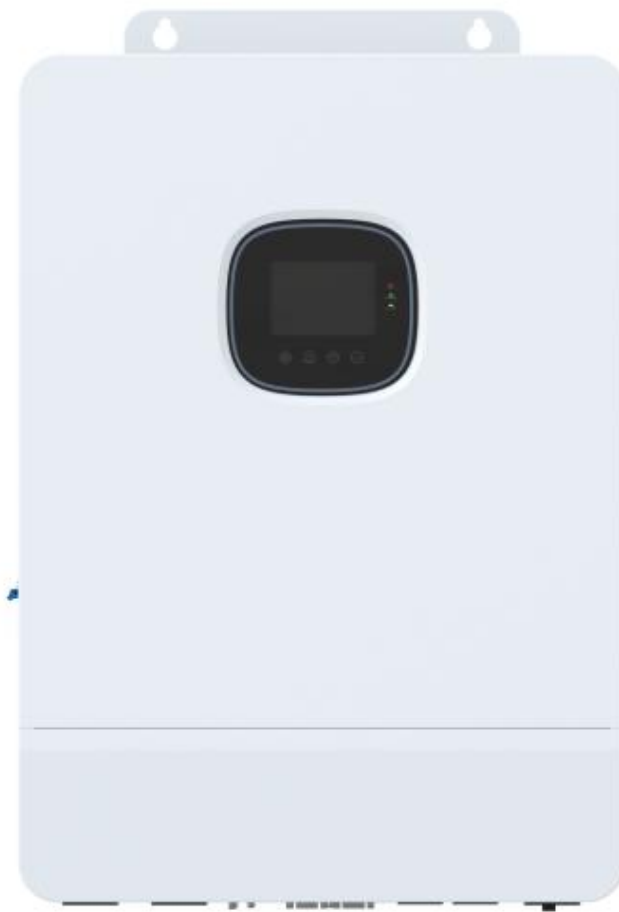

Product Models

SPI-8K-H3P

SPI-10K-H3P

SPI-12K-H3P

CONTENTS

1. Safety	1
1.1 How to use this manual	1
1.2 Symbols in this manual	1
1.3 Safety instruction	1
2. Production Instructions	2
2.1 Instructions	2
2.2 Features	2
2.3 System connection diagram	3
2.4 Production overview	4
3. Installation	5
3.1 Select the mount location	5
3.2 Mount the inverter	6
3.3 Remove terminal protection cover and dust screen	6
4. Connection	7
4.1 Three-phase mode	7
4.2 Cable & circuit breaker requirement	9
4.3 AC input & output connection	10
4.4 Battery connection	11
4.5 PV connection	11
4.6 Dry contact connection	12
4.7 Grounding connection	12
4.8 Final assembly	12
4.9 Parallel wiring	13
4.9.1 Parallel operation	13
4.9.2 Cautions for parallel connection	13
4.9.3 Schematic diagram of parallel connection	14
5. Operation	16
5.1 Operation and display panel	16
5.2 Setting	20
5.3 AC output mode	27
5.4 Battery charging mode	29
5.5 Time-slot charging/discharging function	30
5.6 Battery parameter	31
6. Communication	33
6.1 Overview	33





6.2 USB-B port	33
6.3 WIFI port	34
6.4 RS485/CAN port	34
6.5 Dry contact port	35
7. Fault and Remedy	36
7.1 Fault code	36
7.2 Troubleshooting	40
8. Protection and Maintenance	42
8.1 Protection function	42
8.2 Maintenance	44
9. Datasheet	45

1. Safety

1.1 How to use this manual

- This manual contains important information, guidelines, operation and maintenance for the following products : **SPI H3P series**
- This manual must be followed during installation, use and maintenance.

1.2 Symbols in this manual

Symbols	Description
	DANGER indicates a hazardous situations which if not avoided will result in death or serious injury.
	WARNING indicates a hazardous situations which if not avoided could result in death or serious injury.
	CAUTION indicates a hazardous situations which if not avoided could result in minor or moderate injury.
	NOTICE provide some tips on operation of products.

1.3 Safety instruction

DANGER

- This chapter contains important safety instructions. Read and keep this manual for future reference.
- Be sure to comply the local requirements and regulation to install this inverter.
- Beware of high voltage. Please turn off the switch of each power sources before and during the installation to avoid electric shock.
- For optimal operation of this inverter, select the appropriate cable size and the necessary protective devices as specified.
- Do not connect or disconnect any connections when the inverter working.
- Do not open the terminal cover when the inverter working.
- Make sure the inverter is well grounding.
- Be careful not to cause short-circuiting of the AC output and DC input.
- Do not disassembly this unit, for all repair and maintenance, please take it to the professional service center.

2. Production Instructions

2.1 Instructions

SPI H3P series is a new type of solar energy storage inverter control inverter integrating solar energy storage & utility charging and energy storage, AC sine wave output. It adopts DSP control and features high response speed, reliability, and industrial standard through an advanced control algorithm.

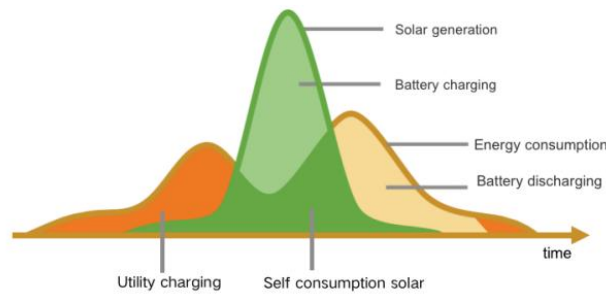

2.2 Features

- Supports lead-acid battery and li-ion battery connections.
- With a dual activation function when the li-ion battery is dormant; either mains or photovoltaic power supply access can trigger the activation of the li-ion battery.
- Support three-phase pure sine wave output (350~415V).
- Supports phase voltage adjustment in the range of 200, 208, 220, 230, 240Vac.
- Supports two PV inputs, with the function of simultaneously tracking the maximum power charging or carrying capacity of two MPPT.
- Dual MPPT, efficiency up to 99.9%, single maximum current of 22A, perfectly adapted to high-power modules.
- 4 charging modes are available: solar only, mains priority, solar priority, and mixed mains and PV charging.
- With time-slot charging and discharging setting function, it helps users to take advantage of peak and valley tariffs and save electricity costs.
- Energy-saving mode function to reduce no-load energy losses.
- With two output modes of utility bypass and inverter output, with uninterrupted power supply function.
- LCD large screen dynamic flow diagram design, easy to understand the system data and operation status.
- 360° protection with complete short-circuit protection, over-current protection, over-voltage protection, under-voltage protection, over-load protection, etc.
- Support CAN, USB, and RS485 communication.

2.3 System connection diagram

The diagram below shows the system application scenario of this product. A complete system consists of the following components:

1. **PV modules:** converts light energy into DC energy, which can be used to charge the battery via an inverter or directly inverted into AC power to supply the load.
2. **Utility grid or generator:** connected to the AC input, either of the connected utility and generator can charge the battery while supplying the load. When the batteries and photovoltaic modules supply the load, the system can operate without the utility or generator.
3. **Battery:** The role of the battery is to ensure the normal power supply of the system loads in case of insufficient photovoltaic and no utility power.
4. **Home load:** connects to a variety of home and office loads including refrigerators, lamps, TVs, fans, air conditioners and other AC loads.
5. **Inverter:** it is the energy conversion device of the whole system.

The actual application scenario determines the specific system cabling.

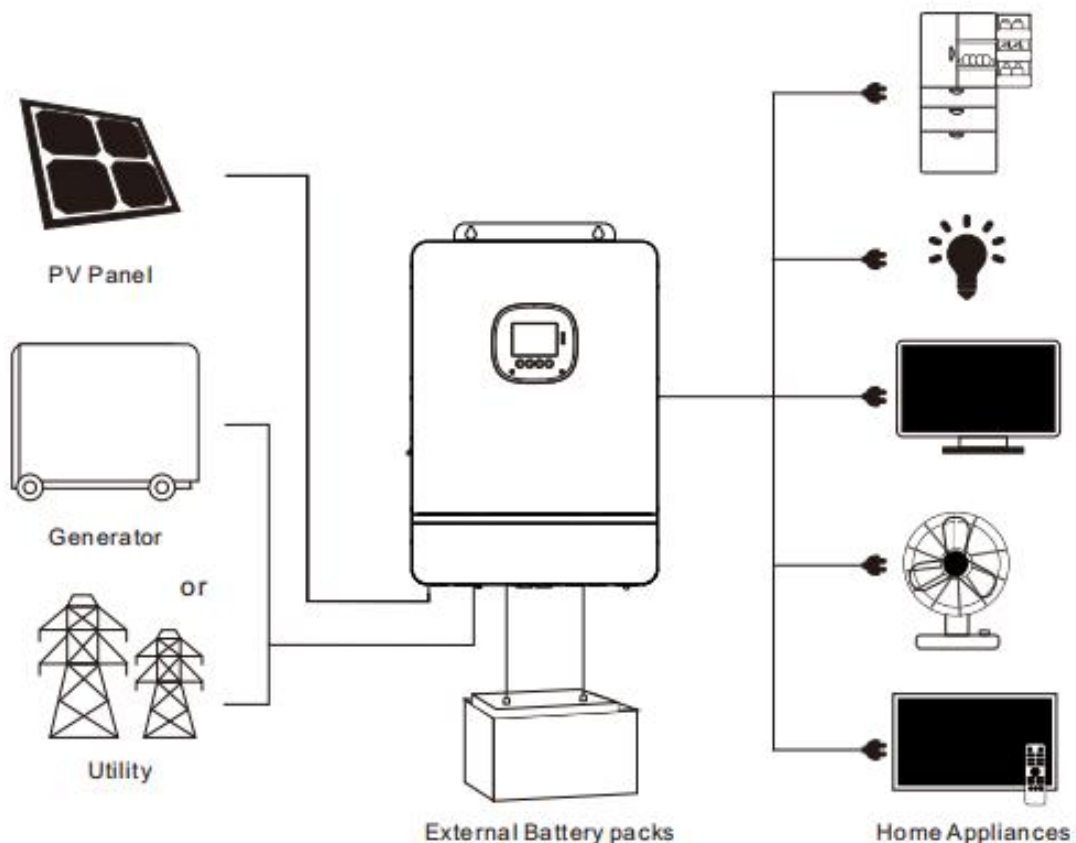

2.4 Production overview

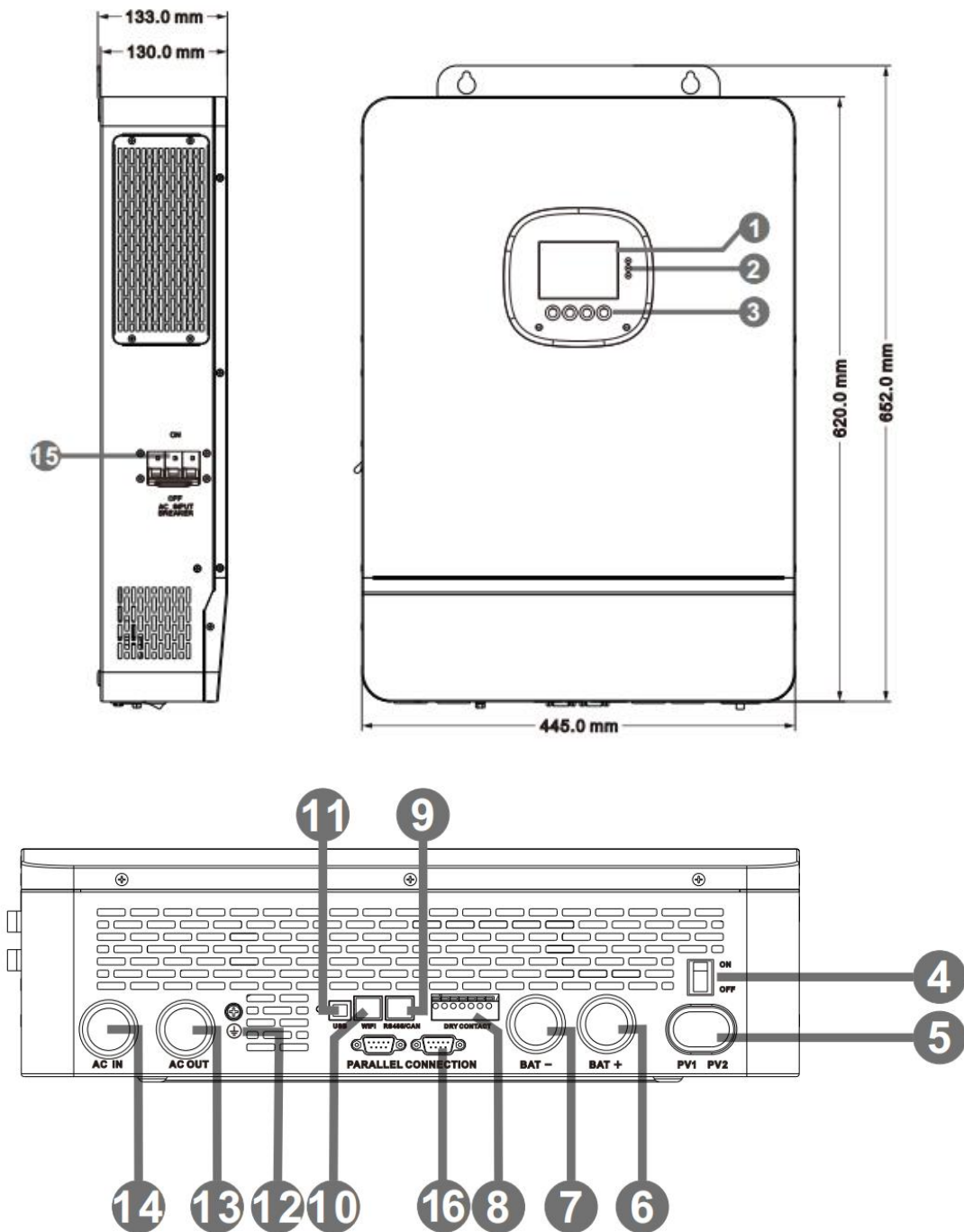

1	LCD screen	2	LED indicator	3	Touchable key
4	ON/OFF rocker switch	5	PV input (PV1+PV2)	6	Battery (positive)
7	Battery (negative)	8	Dry contact	9	RS485/CAN port
10	WIFI port	11	USB-B port	12	Grounding screw
13	AC output (L1+L2+L3 +N)	14	AC input (L 1+L2+L3+N)	15	AC input circuit breaker
16	Parallel connection				

3. Installation

3.1 Select the mount location

SPI H3P series can not be used outdoors (protection degree IP20). Please consider the followings before selecting the location:

- Choose the solid wall to install the inverter.
- Mount the inverter at eye level.
- Adequate cooling space must be provided for the inverter.
- The ambient temperature should be between $-10\sim 55^{\circ}\text{C}$ ($14\sim 131^{\circ}\text{F}$) to ensure optimal operation.

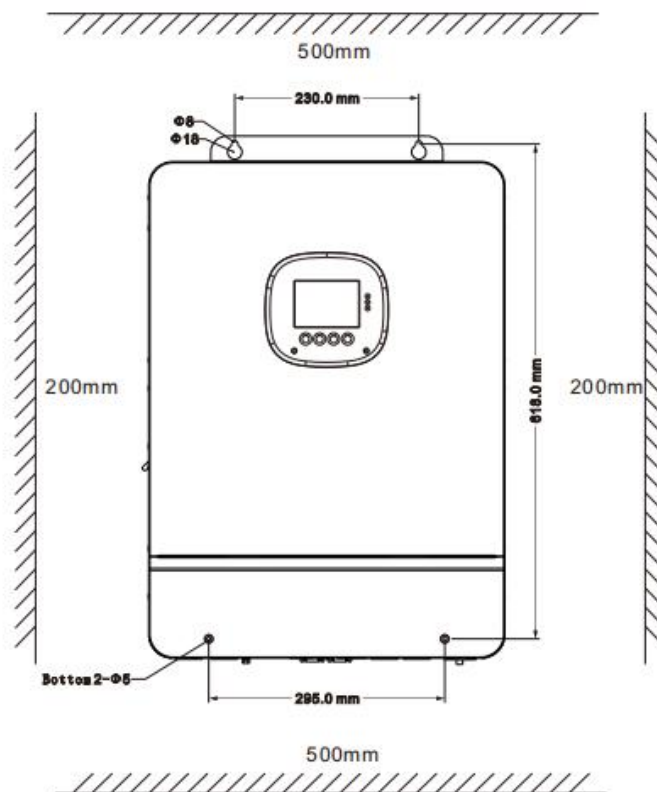

⚠ DANGER

- Do not install the inverter near highly flammable materials.
- Do not install the inverter in a potentially explosive area.
- Do not install the inverter in a confined space with lead-acid batteries.

⚠ CAUTION

- Do not install the inverter in direct sunlight.
- Do not install or use the inverter in a humid environment.

3.2 Mount the inverter

Drill 4 mounting holes in the wall with an electric drill according to the specified dimensions, insert 2 expansion screws above and 2 M5 screws below to fix the inverter.

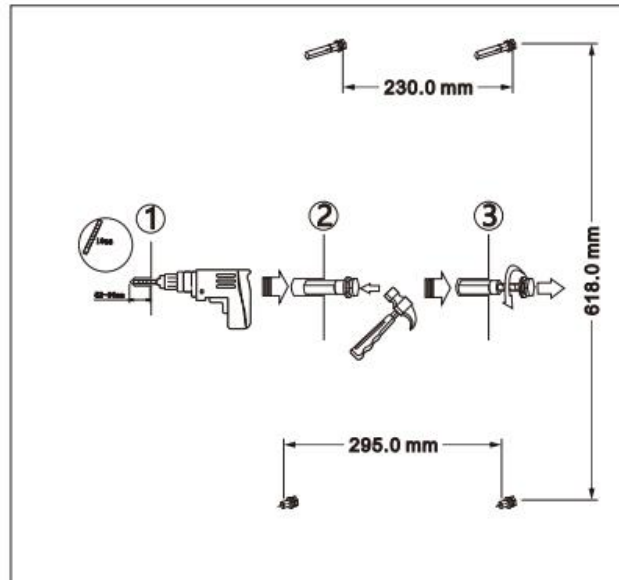

3.3 Remove terminal protection cover and dust screen

Using a screwdriver, remove the terminal protection cover and dust screen.

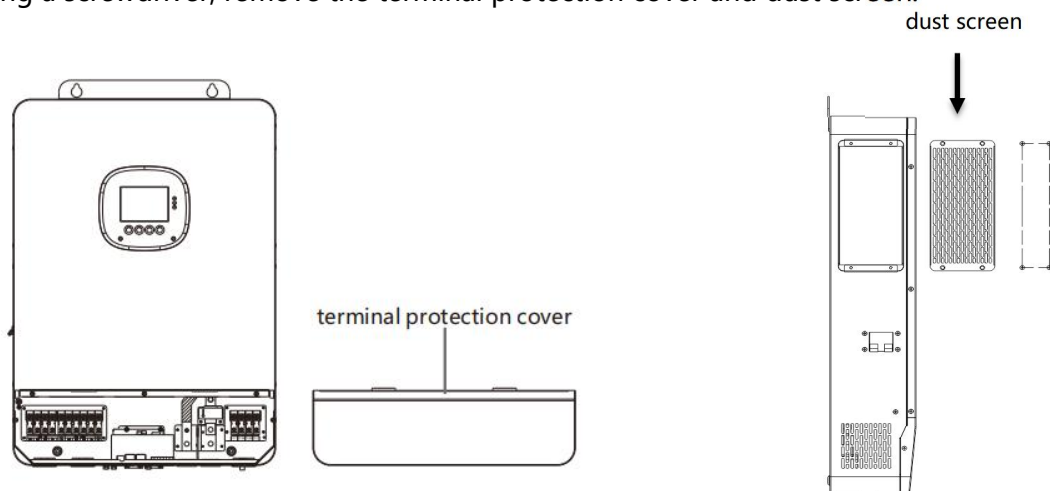

⚠ NOTICE

- When using the device in areas with poor air quality, the dust screen is easily blocked by air particles. Please disassemble and clean the dust screen periodically to avoid affecting the internal air flow rate of the inverter, which may trigger an over-temperature protection fault (19/20 fault) affecting the use of the power supply and the service life of the inverter.

4. Connection

4.1 Three-phase mode

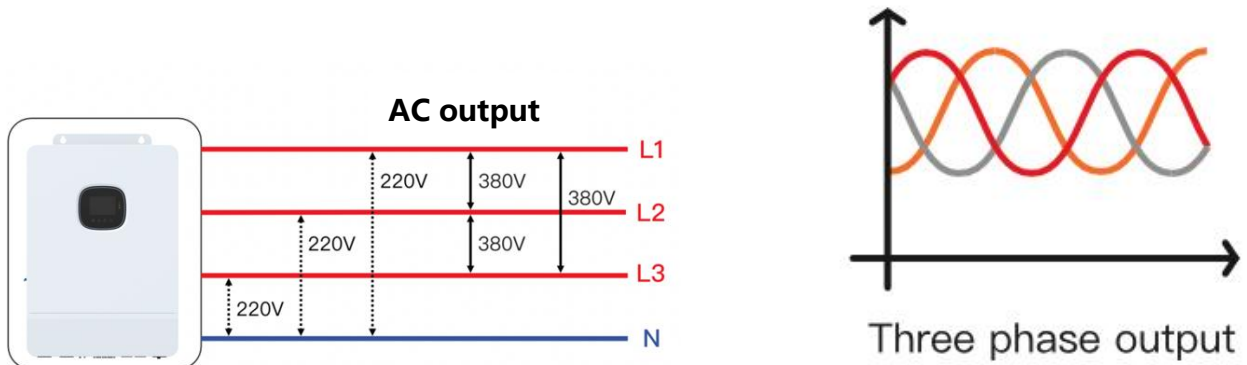

Items	Description
Applicable models	SPI series H3P model
AC output phase voltage (L-N)	200~240Vac, 230Vac default

⚠ NOTICE

- The user can change the output phase mode and output voltage through the setup menu, please read chapter 5.2 for details.
- The output voltage corresponds to item [38] of the parameter setting, and the output phase voltage can be set within the range of 200V to 240V.

Three-phase

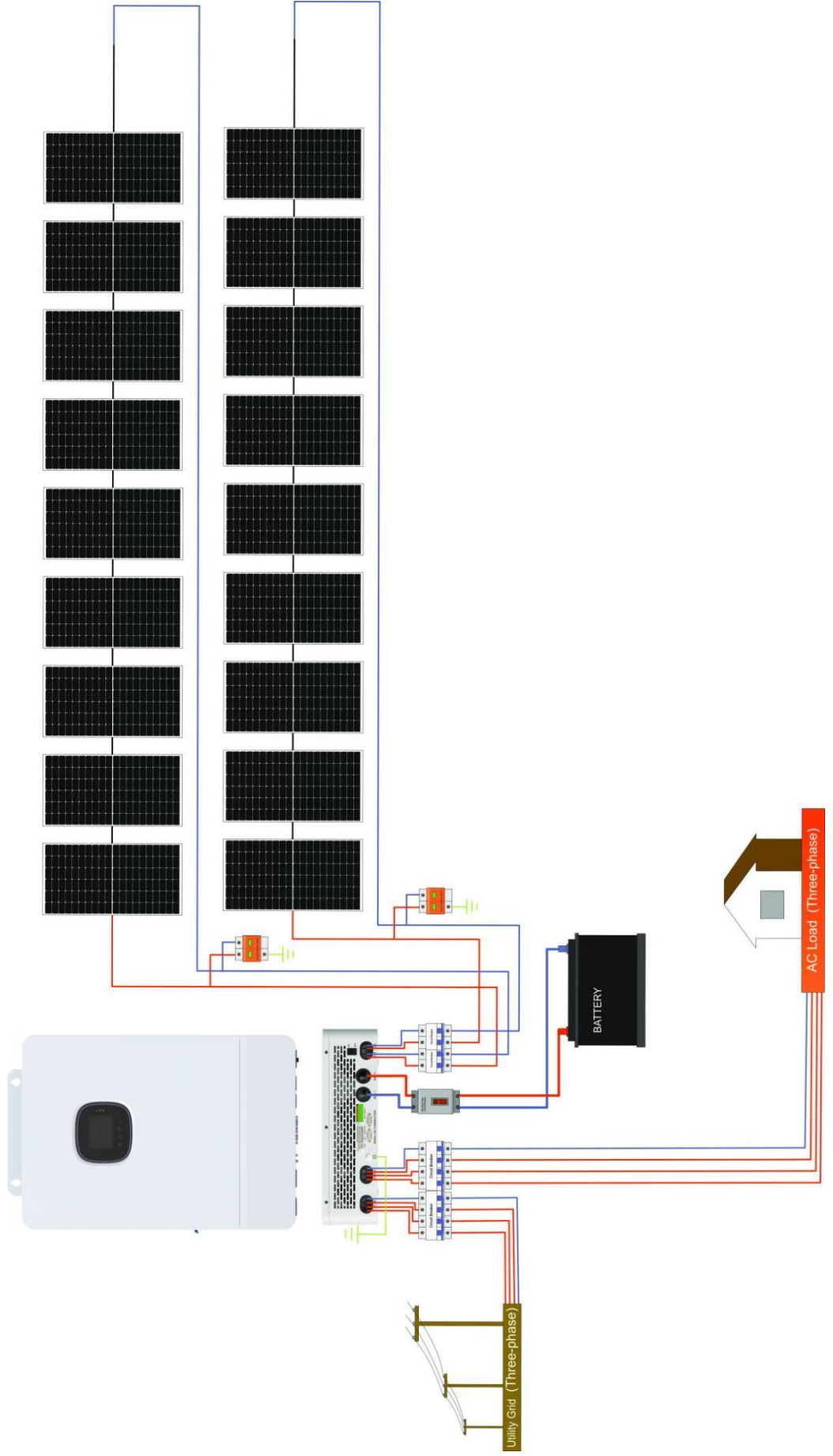

4.2 Cable & circuit breaker requirement

- PV input

Models	Cable Diameter	Max. PV Input Current	Circuit Breaker Spec
SPI-8K-H3P	5mm ² / 10 AWG	22A	2P-25A
SPI-10K-H3P	5mm ² / 10 AWG	22A	2P-25A
SPI-12K-H3P	5mm ² / 10 AWG	22A	2P-25A

- AC input

Models	Output Mode	Max. Current	Cable Diameter	Circuit Breaker Spec
SPI-8K-H3P	Three-phase	23.2A	6mm ² /8 AWG(L1/L2/L3/N)	4P-40A
SPI-10K-H3P	Three-phase	29A	7mm ² /8 AWG(L1/L2/L3/N)	4P-40A
SPI-12K-H3P	Three-phase	35A	9mm ² /6 AWG(L1/L2/L3/N)	4P-40A

- Battery

Models	Cable Diameter	Max. Current	Circuit Breaker Spec
SPI-8K-H3P	34mm ² / 2 AWG	180A	2P-200A
SPI-10K-H3P	42mm ² / 1 AWG	220A	2P-250A
SPI-12K-H3P	50mm ² / 1 AWG	260A	2P-300A

- AC output

Models	Output Mode	Max. Current	Cable Diameter	Circuit Breaker Spec
SPI-8K-H3P	Three-phase	11.6A	6mm ² /8 AWG(L1/L2/L3/N)	4P-40A
SPI-10K-H3P	Three-phase	14.5A	7mm ² /8 AWG(L1/L2/L3/N)	4P-40A
SPI-12K-H3P	Three-phase	17.4A	9mm ² /6 AWG(L1/L2/L3/N)	4P-40A

NOTICE

• **PV input, AC input, AC output**

1. Use a stripper to remove the 6~8mm insulation of the cable.
2. Fixing a ferrule at the end of the cable (ferrule needs to be prepared by the user).

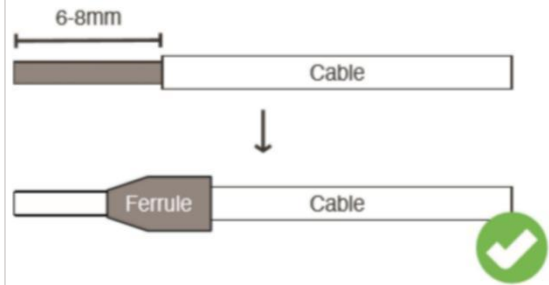

• **Battery**

3. Use a stripper to remove the 6~8mm insulation of the cable.
4. Fixing cable lugs that supply with the box at the end of the cable.

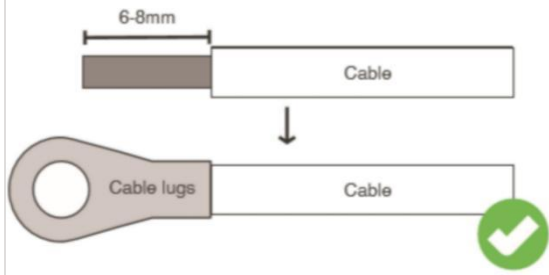

The wire diameter is for reference only. If the distance between the PV array and the inverter or between the inverter and the battery is long, using a thicker wire will reduce the voltage drop and improve the performance of the system.

4.3 AC input & output connection

Connect the live, neutral and ground cables in the position and order of the cables as shown in the diagram below.

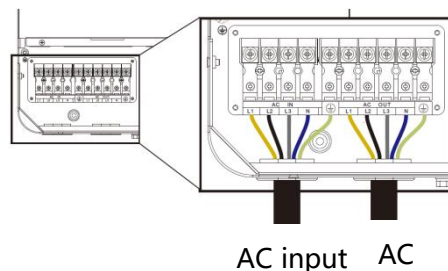

DANGER

- Before connecting the AC input and output, the circuit breaker must be disconnected to avoid the risk of electric shock and must not be operated with electricity.
- Please check that the cable used is sufficient for the requirements, too thin, poor quality cables are a serious safety hazard.

4.4 Battery connection

Connect the positive and negative cable of the battery according to the diagram below.

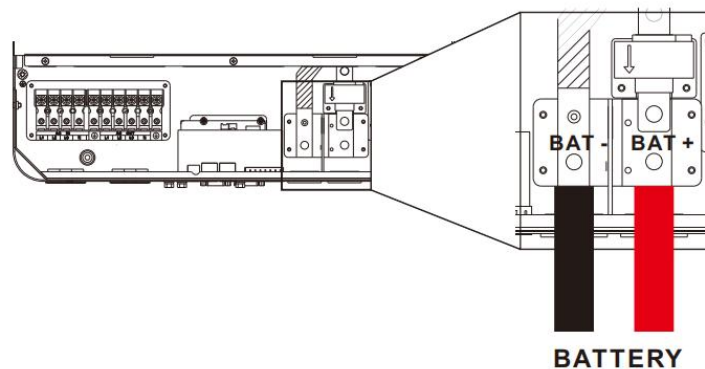

⚠ DANGER

- Before connecting the battery, the circuit breaker must be disconnected to avoid the risk of electric shock and must not be operated with electricity.
- Please ensure that the positive and negative terminals of the batteries are correctly connected and not reversed, otherwise the inverter may be damaged.
- Please check that the cable used is sufficient for the requirements, too thin, poor quality cables are a serious safety hazard.

4.5 PV connection

Connect the positive and negative wires of the two strings of PV according to the diagram below.

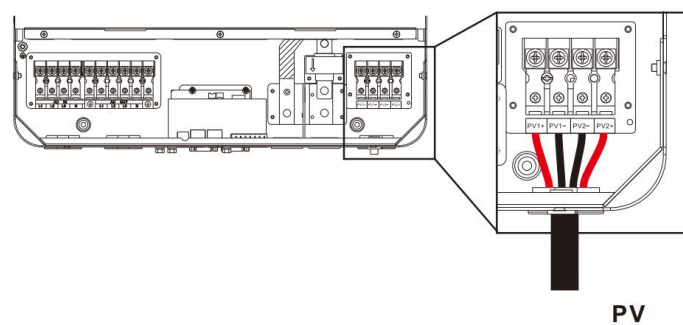

⚠ DANGER

- Before connecting the PV, the circuit breaker must be disconnected to avoid the risk of electric shock and must not be operated with electricity.
- Make sure that the open-circuit voltage of the PV modules connected in series does not exceed the maximum open-circuit voltage of the inverter (the value is 800V), otherwise the inverter may be damaged.

4.6 Dry contact connection

Use a small screwdriver to push back the direction indicated by the arrow, and then insert the communication cable into the dry junction port. (Communication cable cross section 0.2~1.5mm²)

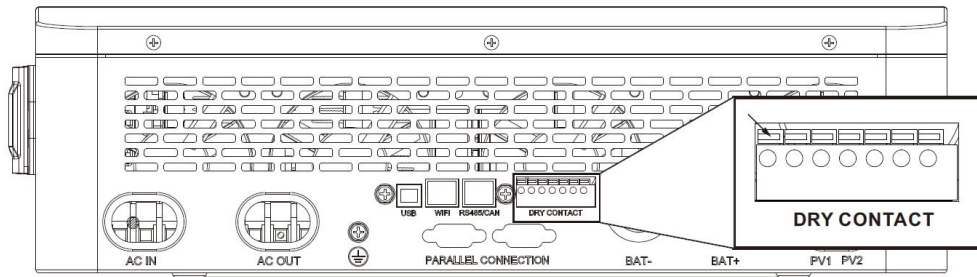

4.7 Grounding connection

Make sure that the earth terminal is securely connected to the grounding busbar.

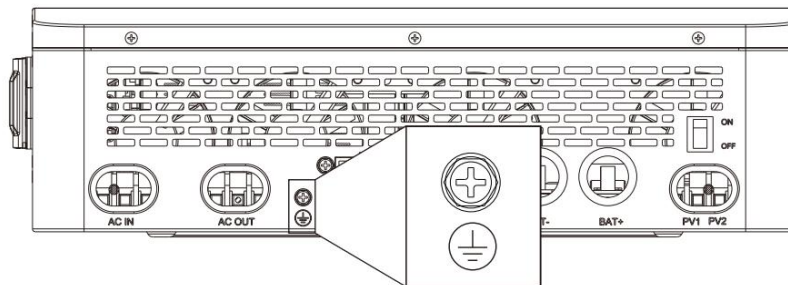

NOTICE

- Grounding wire shall be not less than 4 mm² in diameter and as close as possible to the earthing point.

4.8 Final assembly

After ensuring that the wiring is reliable and the wire sequence is correct, restore the terminal protection cover to its original position.

- Step 1: Close the circuit breaker of the battery.
- Step 2: Press the ON/OFF switch on the bottom of the inverter, the screen and the indicator light come on to indicate that the inverter is activated.
- Step 3: Sequential close of the circuit breakers for PV, AC input and AC output.
- Step 4: Start the loads one by one in order of power from small to large.

4.9 Parallel wiring

4.9.1 Parallel operation

1. The parallel operation supports up to six solar storage inverters.
2. When using the parallel function, it is necessary to connect the parallel communication cable in a correct and reliable manner. See the figure below for the communication cable (packaging accessory):

Parallel communication cable*1

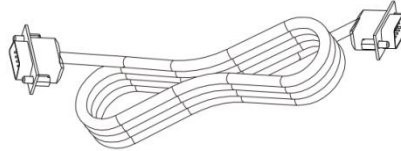

4.9.2 Cautions for parallel connection



Warning:

1. PV wiring:

In parallel connection, the PV array of each inverter must be independent, and the PV array of PV1 and PV2 for one inverter must also be independent.

2. Battery wiring

In single-phase or three-phase parallel connection, all solar storage inverters must be connected to the same battery, with BAT+ connected to BAT+ and BAT- to BAT-, and before power on and start-up, it is necessary to check and ensure correct connection, wiring length, and cable size, so as to avoid the abnormal operation of parallel system output caused by wrong connection.

3. AC OUT wiring:

In single-phase parallel connection, all solar storage inverters must be connected in the manner of L-to-L, N-to-N, and PE-to-PE, and before power on and start-up, it is necessary to check and ensure correct connection, wiring length, and cable size, so as to avoid the abnormal operation of parallel system output caused by wrong connection.

In three-phase parallel connection, all solar storage inverters must be connected in the manner of N-to-N and PE-to-PE. The L lines of all inverters in the same phase shall be connected together, but the AC output L lines of different phases shall not be connected together. Other cautions are the same as those for single-phase parallel connection.

4. AC IN wiring:

In single-phase parallel connection, all solar storage inverters must be connected in the manner of L-to-L, N-to-N, and PE-to-PE, and before power on and start-up, it is necessary to check and ensure correct connection, wiring length, and cable size, so as to avoid the abnormal operation of parallel system output caused by wrong connection. Meanwhile, it is not allowed to have multiple different AC source inputs to avoid damage to the external equipment of the inverter. The AC source input shall be consistent and unique.

In three-phase parallel connection, all solar storage inverters must be connected in the manner of N-to-N and PE-to-PE. The L lines of all inverters in the same phase shall be connected together, but the AC output L lines of different phases shall not be connected together. Other cautions are the same as those for single-phase parallel connection.

5. Communication wiring:

Our company's communication cable for parallel operation is a DB15 standard computer cable with shielding function, and it is used for single-phase or three-phase parallel connection. Each inverter shall be connected with one out and one in, that is, the male connector (out) of the inverter is to be connected to the female connector (in) of the parallel inverter, not the one of the inverter. In addition, DB15 terminal screws will be used to tighten the communication cable of each parallel inverter to avoid falling off or poor contact of the communication cable, followed by abnormal operation or damage of the system output.

6. Before and after connecting the system, please carefully refer to the following system wiring diagrams to ensure that all wiring is correct and reliable before power on.
7. After the system is correctly wired, powered on, and in normal operation, if a new inverter needs to be connected, make sure to disconnect the battery input, PV input, AC input and AC output, and that all solar storage inverters are powered off before reconnecting into the system.

4.9.3 Schematic diagram of parallel connection

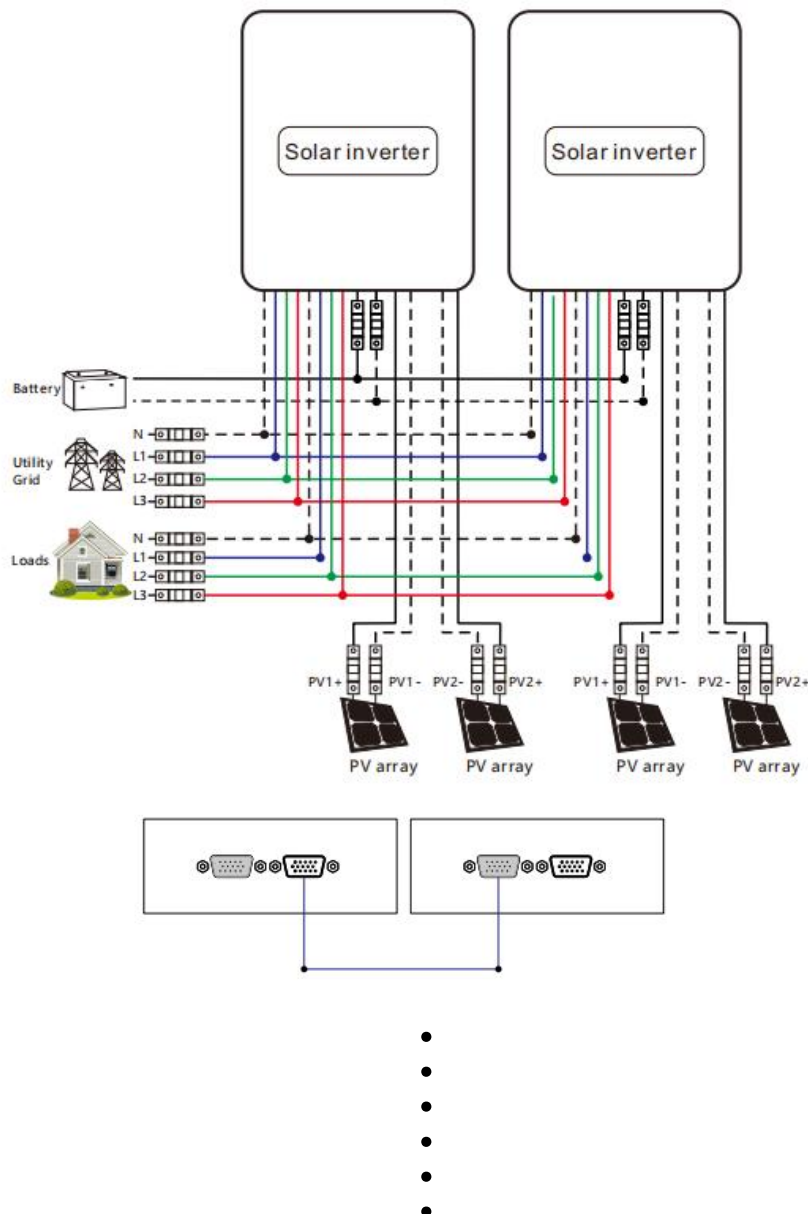

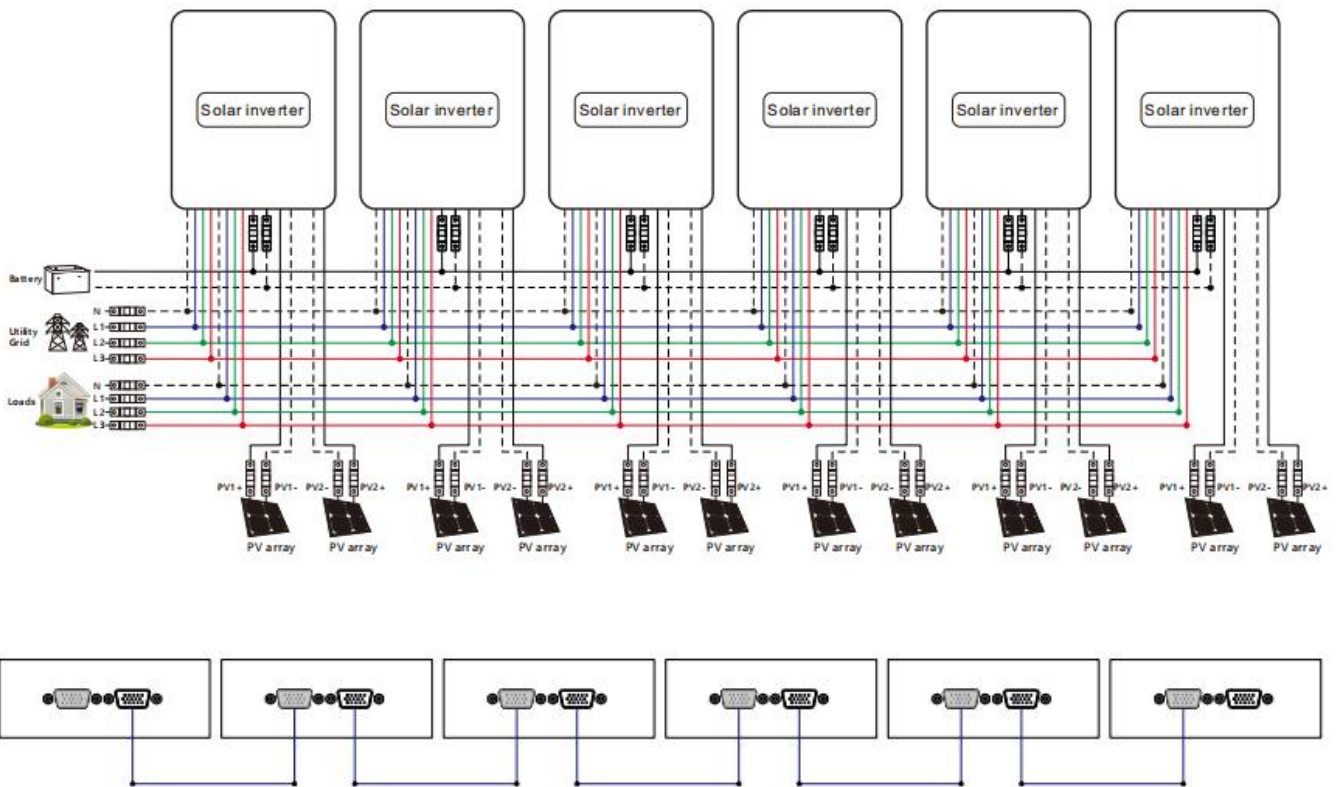



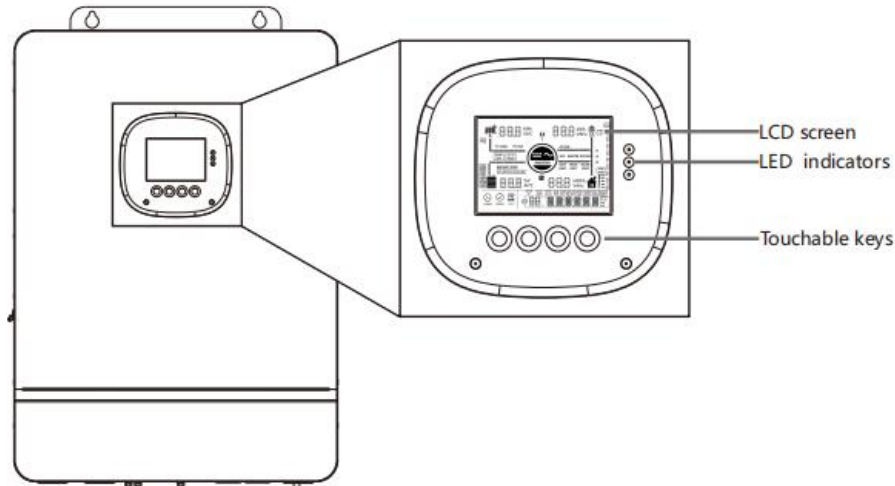

5. Operation

5.1 Operation and display panel

The operation and display panel below includes 1 LCD screen, 3 indicators, 4 touchable keys.



- Touchable keys

Touchable keys	Description
	To enter/exit the setting menu
	To next selection
	To last selection
	To confirm/enter the selection in setting menu







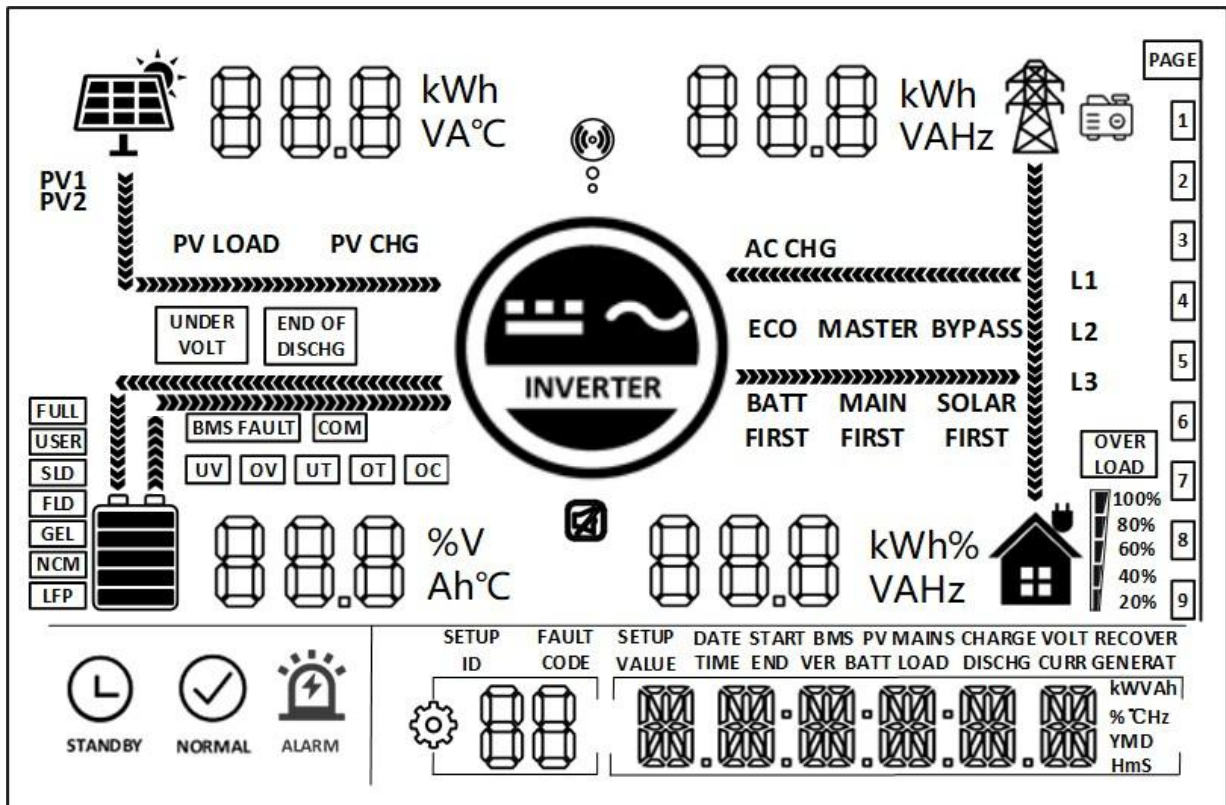



- LED Indicators

LED Indicators	Color	Description
AC/INV	Green	Always on: utility bypass output
		Flash: inverter output
CHARGE	Yellow	Always on: charging complete
		Flash: charging
FAULT	Red	Flash: fault occur

- Display panel



Icon	Description	Icon	Description
	Indicates the PV panel		Indicates the utility grid
	Indicates the battery		Indicates the generator
	Indicates the inverter is working		Indicates the home load
	Indicates the inverter is communicating with data collector		Indicates the buzzer muted
	Indicates the direction of energy flow		
	Indicates the inverter is standby		Indicates the inverter is working normally
	Indicates error occur		Indicates setting

Icon	Description	Icon	Description
	Indicates load power 80%~100%		Indicates battery SOC 80%~100%
	Indicates load power 60%~79%		Indicates battery SOC 60%~79%
	Indicates load power 40%~59%		Indicates battery SOC 40%~59%
	Indicates load power 20%~39%		Indicates battery SOC 20%~39%
	Indicates load power 5%~19%		Indicates battery SOC 5%~19%
UNDER VOLT	Indicates battery under-voltage	END OF DISCHG	Indicates battery discharge stops
OVER LOAD	Indicates over-load	BMS FAULT	Indicates BMS fault
COM	Indicates system communication error	UV	Indicates system under-voltage
OV	Indicates system over-voltage	UT	Indicates system under temperature
OT	Indicates system overtemperature	OC	Indicates system over-current
FULL	Indicates battery is full	USER	Indicates user defined battery
SLD	Indicates sealed lead-acid battery	FLD	Indicates flooded lead-acid battery
GEL	Indicates gel lead-acid battery	NCM	Indicates ternary li-ion battery
LFP	Indicates LFP li-ion battery	ECO	Indicates energy-saving mode
PV LOAD	Indicates PV energy is carrying the load	PV CHG	Indicates PV energy is charging the battery
AC CHG	Indicates AC IN energy is charging the battery	MAIN FIRST	Indicates the inverter output mode is mains power first
BYPASS	Indicates the inverter output mode is bypass	SOLAR FIRST	Indicates the inverter output mode is solar first
BATT FIRST	Indicates the inverter output mode is battery first		

• **View real-time data**

In the main screen, press the UP / DOWN keys to view the real-time data of the inverter during operation.

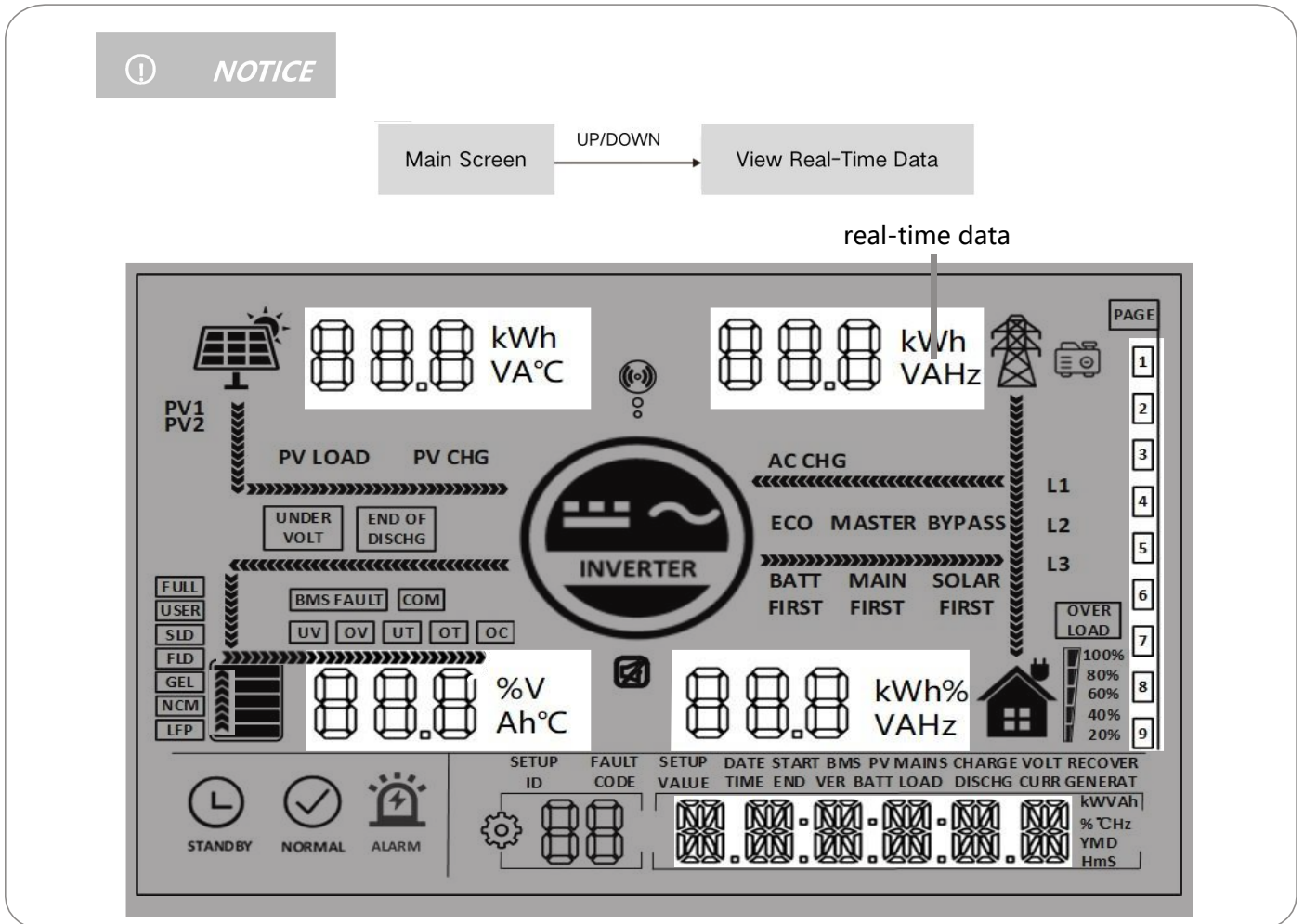

Page	PV side	BAT side	AC IN side	LOAD side	General
1	PV input voltage	Batt Voltage	AC IN voltage	phase voltage	Current Time
2	PV input current	Batt Current	AC IN current	phase current	Current Date
3	PV input power	Batt Voltage	Total AC IN power	phase active power	PV Total kWh
4	PV today kWh	Batt Current	Today AC charging kWh	phase apparent power	Load Total kWh
5	PV side heat sink temperature	INV Heat Sink Temperature	AC frequency	AC output frequency	RS485 Address
6	Rated open-circuit voltage	Batt Rated Voltage	Busbar voltage	Rated output power	Soft Version
7	Max. PV charging current	Max. Batt charging current	Max. AC charging current	Total AC output active power	/
8			/	Total AC output apparent power	/

5.2 Setting

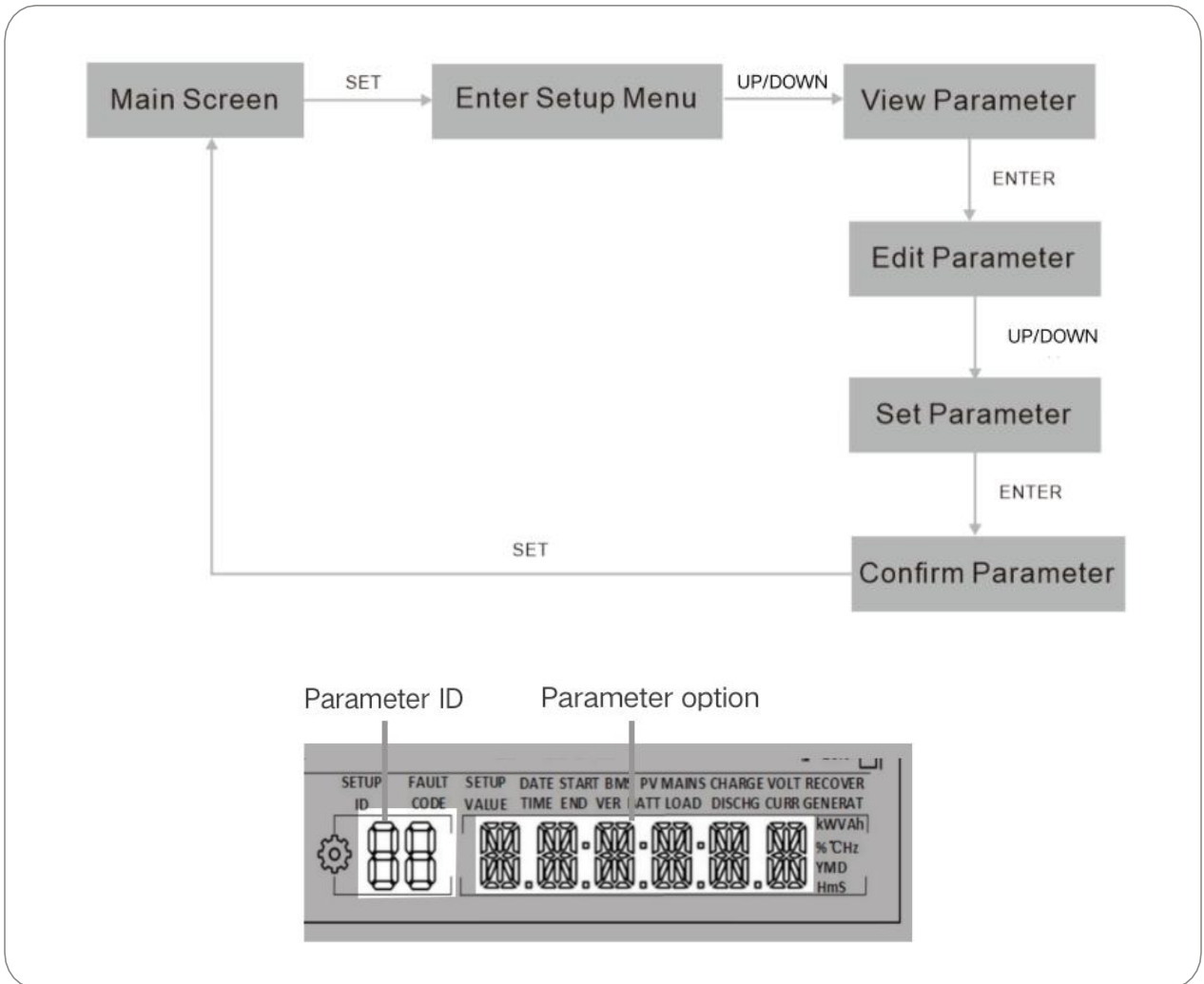

ID	Parameter Meaning	Options	Description
00	Exit	ESC	Exit the setup menu.
01	AC output source priority	UTI default	Utility Priority. Utility power is given priority to the loads, the battery inverts to provide power to the load only when utility power is unavailable.
		SBU	Prioritises the use of PV to power the load and switches back to the mains to power the load only when the battery voltage is lower than the set value in parameter item [4] (when connected to the BMS, according to item [61]). When the battery voltage is higher than the value set in parameter [5] (when connected to the BMS, according to item [62]), it switches back to the PV from the mains to supply the load.
		SUB	PV charging priority, and when PV energy is insufficient, the grid and PV will mix charge and load
		SOL	PV priority. Switching to mains to power the load when PV is not effective or when the battery is below the setting of parameter item [4].
02	AC output frequency	50.0 default	In mains mode the AC output frequency will adapt to the mains frequency, otherwise the output will follow the preset values.
		60.0	
04	Voltage point of battery switch to utility	43.6 default	When parameter [01]= SBU/SOL, output source will switch to utility from battery when the battery voltage below the preset value. Setting range:40~52V.
05	Voltage point of utility switch to battery	57.6default	When parameter [01]=SBU/SOL, output source will switch to battery from utility when the battery voltage above the preset value. Range:48~60V.
06	Battery charging mode	SNU default	Solar and utility charging the battery at the same time, solar at the first priority, utility power as a supplement when solar power is not sufficient. When solar power is sufficient, the utility stops charging. Note: The PV and mains can only be charged at the same time when the mains bypass output is loaded. When the inverter is operating, only PV charging can be initiated, not utility charging.
		OSO	PV charging only, no utility charging.

ID	Parameter Meaning	Options	Description
07	Battery charging current	120A default	Corresponding to SPI-8K-H3P, setting range 0~180A.
			Corresponding to SPI-10K-H3P, setting range 0~220A.
			Corresponding to SPI-12K-H3P, setting range 0~260A.
08	Battery type	USER	User-defined, user can set all battery parameter.
		SLd	Sealed lead-acid battery.
		FLd	Flooded lead-acid battery.
		GEL default	Gel lead-acid battery.
		L14/ L15/ L16	L14/ L15/ L16 lithium iron phosphate batteries, corresponding to lithium iron phosphate batteries 14, 15, 16 series.
		N13/ N14	Ternary lithium batteries, N13/N14, corresponding to ternary lithium batteries 13 series, 14 series.
		No bat	No battery
09	Battery boost charging voltage	57.6 default	Setting range 48V~58.4V, step 0.4V, valid when battery type is custom and lithium battery.
10	Boost charging maximum time	[10] 120 default	Boost charging maximum time setting, refers to the constant voltage charging when the voltage reaches the parameter [09] setting voltage maximum charging time, set the range of 5min~900min, step of 5 minutes, valid when battery type is user-defined and lithium battery.
11	Battery float charging voltage	55.2 default	Setting range 48V~58.4V, step 0.4V, this parameter can not be set after the BMS communication is successful.
12	Battery over discharge voltage (delay powering off)	42 default	When the battery voltage is lower than the judgement point, and triggers the parameter [13], the inverter output is switched off, the setting range is 40V~48V, the step is 0.4V, valid when battery type is custom and lithium battery.
13	Battery over-discharge delay time	5 default	The battery voltage is lower than parameter [12], and the inverter output is switched off after triggering the delay time set in this parameter, the setting range is 5S~50S, the step is 5S, valid when battery type is custom and lithium battery.

14	Battery under-voltage alarm point	44 default	When the battery voltage is lower than this judgement point, the device will under-voltage alarm, the output will not be switched off, the setting range is 40V~52V, the step is 0.4V, valid when battery type is custom and lithium battery.
15	Battery discharge limiting voltage	40 default	When the battery voltage is lower than the value of this parameter item, the output will be switched off immediately. Setting range 40V~52V, step 0.4V, valid when battery type is custom and lithium battery.

ID	Parameter Meaning	Options	Description
16	Battery equalization charging	DIS	Disable equalization charging.
		ENA default	Enable equalization charging, valid when battery type is FLd, SLd, and USER.
17	Battery equalization charging voltage	58	Setting range 48V~58V in 0.4V steps, valid when battery type is FLd, SLd, and USER.
18	Battery equalization charging duration	120	Setting range 5min~900min in 5 minute steps, valid when battery type is FLd, SLd, and USER.
19	Battery equalization charging delay time	240	Setting range 5min~900min in 5 minute steps, valid when battery type is FLd, SLd, and USER.
20	Battery equalization charging interval	30	Setting range 0~30days in 1 day steps, valid when battery type is FLd, SLd, and USER.
21	Battery equalization charging stop-start	DIS default	Start equalization charging immediately.
		ENA	Stop equalization charging immediately.
22	Energy-saving mode	DIS default	Disable energy-saving mode.
		ENA	Enable energy-saving mode, when the load power is less than 25W, the output of the inverter will switch off after a 5-minute delay. When the load exceeds 25W, the inverter will restart automatically.
23	Overload automatic restart	DIS	Disable overload automatic restart, if an overload occurs to shut down the output, the machine will not be restored to power on again.
		ENA default	Enable overload automatic restart. If an overload occurs that shuts down the output, the machine delays for 3 minutes before restarting the output. After accumulating 5 times, it will not restart again.
24	Over-temperature automatic restart	DIS	Disable over-temperature automatic restart, if over-temperature occurs to switch off the output

			machine no longer switch on the output.
		ENA default	Enable over-temperature automatic restart, if over-temperature occurs the output is switched off, it will be switched on when the temperature drops.
25	Buzzer alarm	DIS	Disable buzzer alarm.
		ENA default	Enable buzzer alarm.
26	Mode change alert	DIS	Disable alert when the status of the main input source changes.
		ENA default	Enable alert when the status of the main input source changes.

ID	Parameter Meaning	Options	Description
27	Inverter overload switch to bypass	DIS	Disable automatic switching to mains to power the load in the event of an inverter overload.
		ENA default	Automatic switching to mains to power the load in the event of an inverter overload.
28	Utility charging current	100A	Corresponds to SPI-8K-H3P, setting range 0~100A.
		120A	Corresponds to SPI-10K-H3P, setting range 0~120A.
		120A	Corresponds to SPI-12K-H3P, setting range 0~120A.
30	RS485 communication address	ID:1	RS485 address setting range: 1~254.
31	AC output mode (can be set in the standby mode only)	[31] SIG default	When single inverter is used, the default is SIG mode.
		[31] PAL	In parallel operation
32	RS485 communication	DIS default	Disable the BMS communication function.
		485	RS485 BMS communication function.
		CAN	CAN BMS communication function.
33	BMS communication	When item [32] = 485/CAN, the corresponding lithium battery manufacturer brand should be selected for communication.	
		WOW default	485 protocol: PAC=PACE, RDA=RITAR, AOG=ALLGRAND, OLT=OLITER, CEF=CFE, XYD=SUNWODA, DAQ=DYNESS, WOW=SRNE, PYL=PYLONTECH, POW=POWMr, UOL=VILION.

			CAN protocol: UZE=YUZE
34	On-grid and hybrid power supply load	DIS default	Disable this function.
		ON GRD	When parameter [01]=UTI, the solar energy is given priority charging, and when the load demand is met, the remaining power will be fed back to the grid.
35	Battery under-voltage recovery point	52	When the battery is under-voltage, the battery voltage needs to be higher than this setting value in order to restore the battery inverter AC output, setting range: 44V~54.4V.
37	Recharge voltage point after battery is full	52	Inverter stops charging when the battery is full. Inverter resumes charging when the battery voltage below this value. Setting range: 44V~54V.
38	AC output phase voltage	230	Setting range: 200/208/220/230/240Vac.
39	Charging current limiting method (when BMS is enabled)	[SET] The maximum battery charging current is limited according to the setting in [07].	
		[BMS] Default Maximum battery charging current is limited according to the current limit value of the BMS.	
		[INV] Maximum battery charging current is limited by the machine's derating logic.	

ID	Parameter Meaning	Options	Description
40	1st time slot start mains charging / carrying loads	00:00:00	Setting range: 00:00:00-23:59:00.
41	1st time slot end mains charging / carrying loads	00:00:00	Setting range: 00:00:00-23:59:00.
42	2nd time slot start mains charging / carrying loads	00:00:00	Setting range: 00:00:00-23:59:00.
43	2nd time slot end mains charging / carrying loads	00:00:00	Setting range: 00:00:00-23:59:00.
44	3rd time slot start mains charging / carrying loads	00:00:00	Setting range: 00:00:00-23:59:00.
45	3rd time slot end mains charging /	00:00:00	Setting range: 00:00:00-23:59:00.

	carrying loads		
46	Time slot mains charging / carrying loads function	DIS default	Disable this function.
		ENA	When the time slot mains charging / carrying loads function is enabled, the power supply mode will change to SBU and switch to mains charging only during the set charging period or when the battery is over-discharged. If the time slot discharging function is enabled at the same time, the system power supply mode will change to UTI, and will only switch to the mains for charging during the set charging period, and switch to the battery inverter power supply during the set discharging period or when the mains is outaged.
47	1st time slot start battery discharging	00:00:00	Setting range: 00:00:00-23:59:00.
48	1st time slot end battery discharging	00:00:00	Setting range: 00:00:00-23:59:00.
49	2nd time slot start battery discharging	00:00:00	Setting range: 00:00:00-23:59:00.
50	2nd time slot end battery discharging	00:00:00	Setting range: 00:00:00-23:59:00.
51	3rd time slot start battery discharging	00:00:00	Setting range: 00:00:00-23:59:00.

ID	Parameter Meaning	Options	Description
52	3rd time slot end battery discharging	00:00:00	Setting range: 00:00:00-23:59:00.
53	Time slot battery discharging function	DIS default	Disable this function.
		ENA	When the time slot battery discharging function is enabled, the power supply mode will be switched to UTI, and the system will switch to battery inverter power supply only during the set discharge period or when the mains is outaged.
54	Local date	00:00:00	YY/MM/DD. Setting range: 00:01:01-99:12:31.
55	Local time	00:00:00	Setting range: 00:00:00-23:59:59.
56	Leakage current detection protection	DIS default	Disable detecting Leakage current value.
		ENA	Enable detecting Leakage current value.
57	Stop charging current	3	Charging stops when the charging current is less than this setting (unit: A).

58	Discharging alarm SOC setting	15	Triggers an alarm when the battery SOC is less than the set value (unit:%, valid only when BMS communication is normal)
59	Discharging cut-off SOC setting	5	Stops discharging when the battery SOC is less than the set value (unit:%, valid only when BMS communication is normal)
60	Charging cut-off SOC setting	100	Stops charging when the battery SOC is higher than the set value (unit:%, valid only when BMS communication is normal)
61	Switching to utility SOC setting	10	Switch to utility power when the battery SOC is less than this setting value (unit:%, valid only when BMS communication is normal)
62	Switching to inverter output SOC setting	100	Switches to inverter output mode when SOC is higher than this setting value (unit:%, valid only when BMS communication is normal)
63	N-PE bonding automatic switching function	DIS default	Disable automatic switching of N-PE connections.
		ENA	Enable automatic switching of N-PE connections.
67	On grid max power	0 default	you can set the max on-grid power(less than the inverter rated power)
70	Insulation impedance detection	DIS default	Disable detecting insulation impedance value.
		ENA	Enable detecting insulation impedance value.

5.3 AC output mode

The AC output mode corresponds to the parameter operating priority mode and the utility hybrid with load function setting item, allowing the user to set manually.

- **Utility Priority Output 01 UTI (default)**

Utility priority, switching to inverter only when utility is outaged (Priority: Utility > PV > Battery)

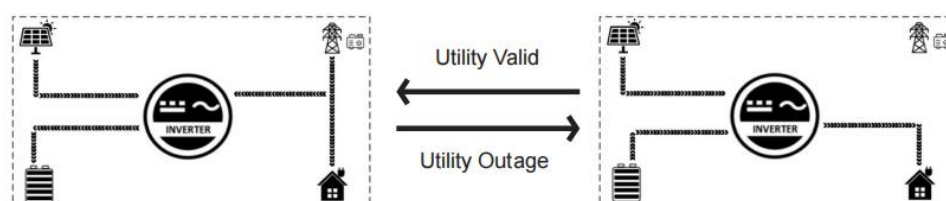

- **Solar and Utility Hybrid Output MIX LOD**

In UTI mode and parameter [34]=MIX LOD, when not connected to the battery or when the battery is full,

the solar and the utility supply power to the load at the same time. (Priority: PV > Utility > Battery)



• **Solar Priority Output 01 SOL**

The PV gives priority to powering the load, and when the PV meets the load, the excess power charges the battery.

When the PV energy is insufficient, the battery replenishes to power the load.

When the PV is ineffective, switches to mains power, and then finally to use battery power.

When the PV energy is insufficient, as well as when the battery falls below the parameter (battery to mains) or switching to the mains SOC setting value, switches to mains power supply to the load and charging, where the PV's energy is charged, without load. This mode maximises the use of the PV while maintaining battery power and is suitable for areas with stable grids.

(Priority: PV > Utility > Battery)

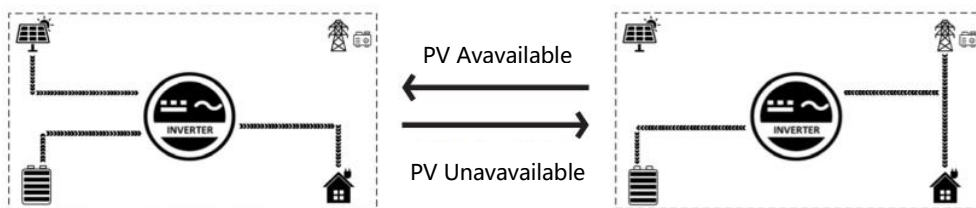

• **Inverter Priority Output 01 SbU**

The PV will supply power to the loads on a priority basis. If the PV is insufficient or unavailable, the battery will be used as a supplement to supply power to the load. When the battery voltage touches the value of parameter [04] (Voltage point of battery switch to utility), it will switch to utility power supply to the load (without BMS connected) / When the BMS is connected and the Li-ion battery SOC touches the value of parameter [61] (Switching to utility SOC setting), it will switch to utility power supply to the load. This mode maximises the use of DC energy, and it is suitable for the areas where the power grid is stable. (Priority: PV > Battery > Utility)

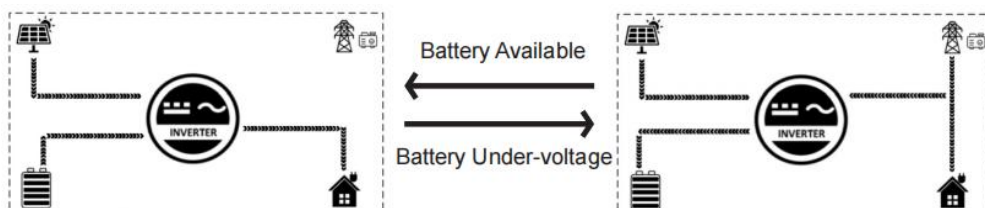

5.4 Battery charging mode

The charging mode corresponds to parameter [06], which allows the user to set the charging mode manually.

- **Hybrid Charging SNU (default)**

PV and mains power charge the battery at the same time, with PV taking priority and mains power acting as a supplement when PV is insufficient. This is the fastest charging method and is suitable for areas with insufficient power supply, providing sufficient backup power for users.

(Priority: PV > Utility)

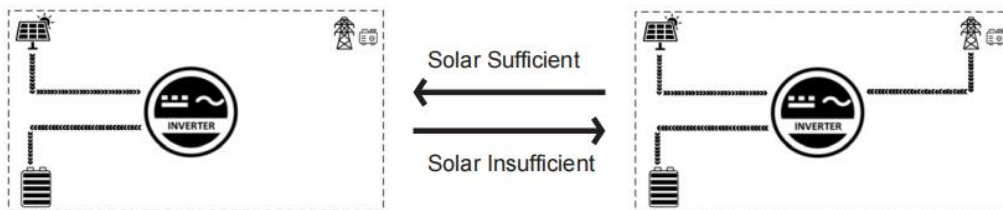

- **Only Solar Charging OSO**

Only PV power is used to charge the battery, without starting the mains charging. This is the most energy-efficient method, with all battery power coming from solar energy, and is usually used in areas with good radiation conditions.

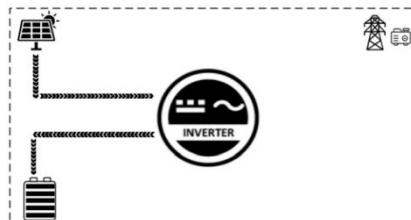

5.5 Time-slot charging/discharging function

SPI H3P series is equipped with time-slot charging / discharging function, users can set different charging/discharging time slots according to the local peak and valley electricity price, so as to make efficient use of utility power and PV energy. When the utility price is expensive, the battery inverter can be used to supply power to the loads. When the utility price is cheap, the utility power can be used to supply and charge the loads, which can help users save the electricity bill to the greatest extent. Users can turn on/off the time-sharing charging/discharging function in the setting menu parameters [46] and [53], and set the charging and discharging time periods in parameters [40-45], [47-52] for timed mains charging start/time setting and timed battery discharging start/time setting. Here is a case example to help users understand the function.

NOTICE

Before using this function for the first time, please set the local time in parameter [54], [55], then the user can set the corresponding time slot according to the local peak and valley tariff charges.

Peak-Valley Electricity Tariff



Time-slot Utility Charging/Carrying Function



With 3 definable periods, the user can freely set the mains charging/carrying time within the range of 00:00 to 23:59. During the time period set by the user, if PV energy is available, PV energy will be used first, and if PV energy is not available or insufficient, utility energy will be used as a supplement.

Time-slot Battery Discharging Function



With 3 definable time periods, users can freely set the battery discharge time within the range of 00:00 to 23:59. During the time period set by the user, the inverter will give priority to the battery inverter to carry the load, and if the battery power is insufficient, the inverter will automatically switch to mains power to ensure stable operation of the load.

5.6 Battery parameter

- Lead-acid battery

Parameter/Battery type	Sealed	Gel	Flooded	User-defined
	SLd	GEL	FLd	USE
Over-voltage cut-off voltage	60V	60V	60V	60V
Equalization charging voltage	58V	56.8V	58V	40~60V settable
Bulk charging voltage	57.6V	56.8V	57.6V	40~60V settable
Float charging voltage	55.2V	55.2V	55.2V	40~60V settable
Under-voltage alarm voltage	44V	44V	44V	40~60V settable
Under-voltage cut-off voltage	42V	42V	42V	40~60V settable
Discharging limit voltage	40V	40V	40V	40~60V settable
Over-discharge delay time	5s	5s	5s	1~30s settable
Equalization charging duration	120m	-	120min	0~600min settable
Equalization charging interval	30d	-	30d	0~250d settable
Bulk charging interval	120min	120min	120min	10~900m settable

NOTICE

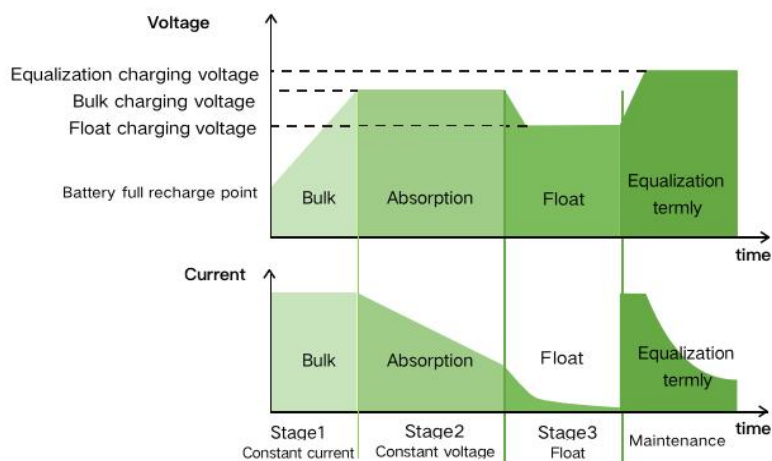

- Li-ion battery

Parameter/Battery type	Ternary		LFP			User-defined
	N13	N14	L16	L15	L14	USE
Over-voltage cut-off voltage	60V	60V	60V	60V	60V	60V
Equalization charging voltage	-	-	-	-	-	40~60V settable
Bulk charging voltage	53.2V	57.6V	56.8V	53.2V	49.2V	40~60V settable
Float charging voltage	53.2V	57.6V	56.8V	53.2V	49.2V	40~60V settable
Under-voltage alarm voltage	43.6V	46.8V	49.6V	46.4V	43.2V	40~60V settable
Under-voltage cut-off voltage	38.8V	42V	48.8V	45.6V	42V	40~60V settable
Discharging limit voltage	36.4V	39.2V	46.4V	43.6V	40.8V	40~60V settable
Over-discharge delay time	30s	30s	30s	30s	30s	1~30s settable
Equalization charging duration	-	-	-	-	-	0~600min settable
Equalization charging interval	-	-	-	-	-	0~250d settable
Bulk charging interval	120min settable	120min settable	120min settable	120 m settable	120 m settable	10~900min settable

① NOTICE

If no BMS is connected, the inverter will charge according to battery voltage with a preset charging curve. When the inverter communicates with the BMS, it will follow the BMS instructions to perform a more complex stage charging process.

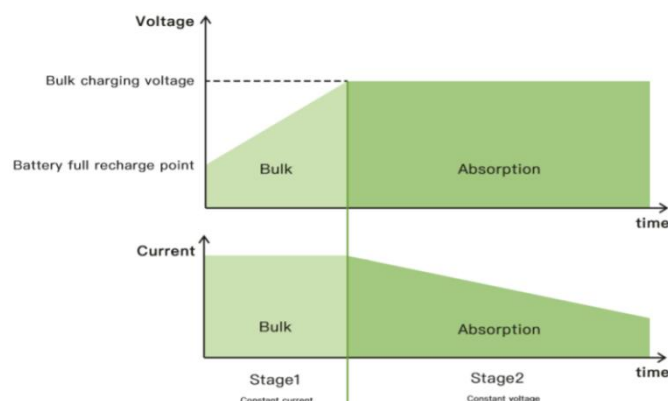

6. Communication

6.1 Overview

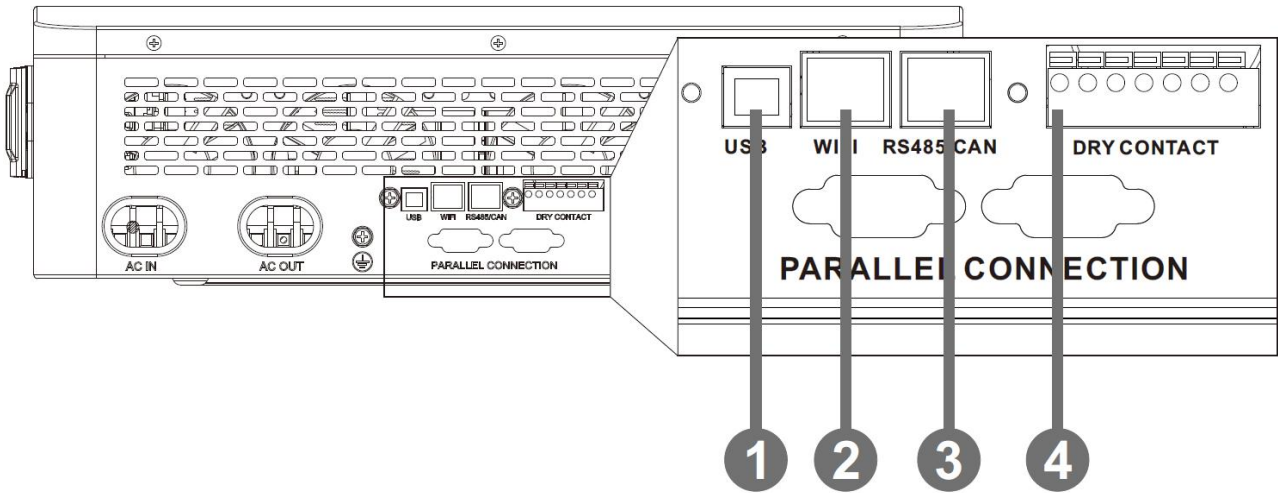

1	USB-B port	3	RS485/CAN port
2	WIFI port	4	Dry contact port

6.2 USB-B port

Users can use the host computer software to read and modify the device parameters through this port. If you need the installation package of the host computer software, you can download it from the official website of SRNE or contact us to get the installation package.

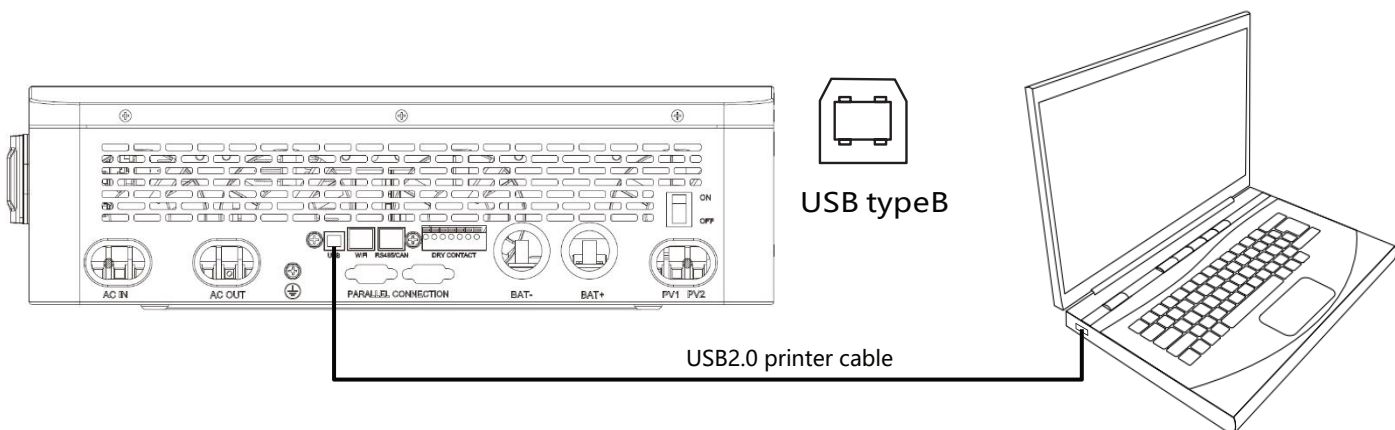

6.3 WIFI port

The WIFI port is used to connect to the Wi-Fi/GPRS data acquisition module, which allows users to view the operating status and parameters of the inverter via mobile phone APP.

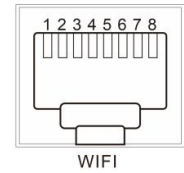
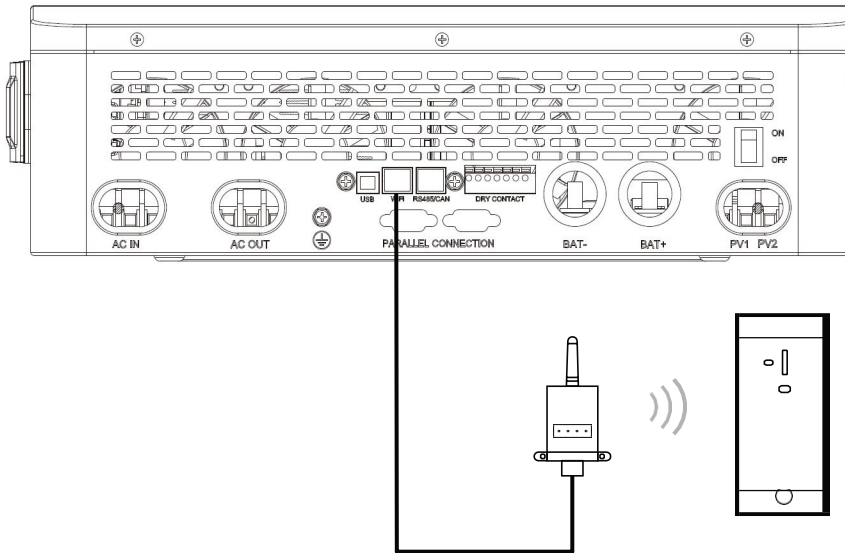

RJ45	Definition
Pin 1	5V
Pin 2	GND
Pin 3	/
Pin 4	/
Pin 5	/
Pin 6	/
Pin 7	RS485-A
Pin 8	RS485-B

6.4 RS485/CAN port

The RS485/CAN port is used to connect to the BMS of Li-ion battery.

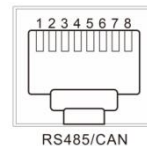

NOTICE

If you need to use the inverter to communicate with the lithium battery BMS, please contact us for the communication protocol or upgrade the inverter to the appropriate software programme.

RJ45	Definition
Pin 1	RS485-B
Pin 2	RS485-A
Pin 3	/
Pin 4	CANH
Pin 5	CANL
Pin 6	/
Pin 7	RS485-A
Pin 8	RS485-B

6.5 Dry contact port

Dry contact port with 4 functions:

1. Remote switch on/off
2. Switching signal output
3. Battery temperature sampling
4. Generator remote start/stop

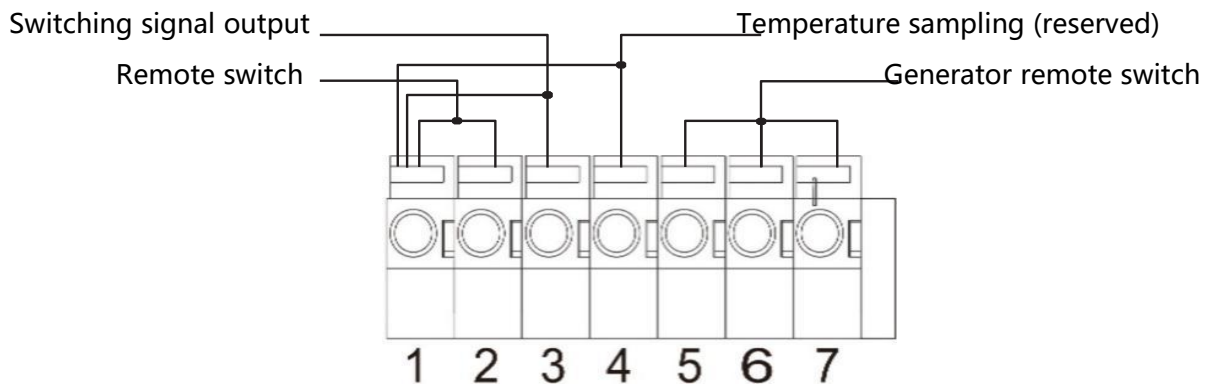

Function	Description
Remote switch	When pin 1 is connected with pin 2, the inverter will switched off the AC output. When pin1 is disconnected from pin2, the inverter outputs normally.
Switching signal output	When the voltage of battery reaches the battery discharge limiting voltage (parameter [15]), pin 3 to pin 1 voltage is 0V. When the battery charging is normal, pin 3 to pin 1 voltage is 5V.
Temperature sampling (reserved)	Pin 1 & Pin 4 can be used for battery temperature sampling compensation.
Generator remote switch	When the voltage of battery reaches the battery under-voltage alarm point (parameter [14]) or voltage point of battery switch to utility (parameter [04]), pin 6 to pin 5 normally open, pin 7 to pin 5 normally close. When the voltage of battery reaches the voltage point of utility switch to battery (parameter [05]) or battery is full, pin 6 to pin 5 normally close, pin 7 to pin 5 normally open. (Pin 5/6/7 outputs 125Vac/1A, 230Vac/1A,30Vdc/1A)

① NOTICE

If you need to use the remote start/stop function of the generator with dry contact, ensure that the generator has ATS and supports remote start / stop.

7. Fault and Remedy

7.1 Fault code

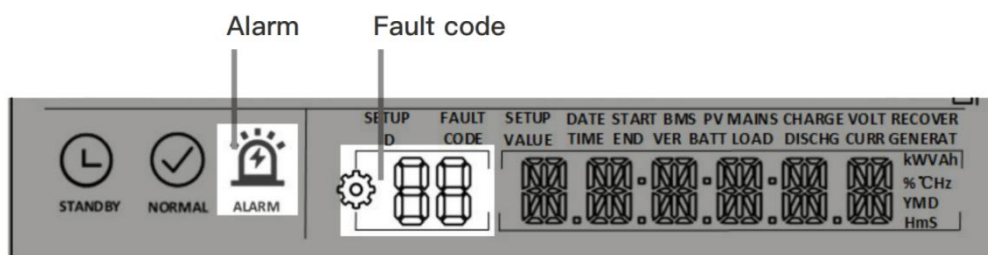

Fault Code	Meaning	Does it Affect the outputs	Descriptions
【01】	BatVoltLow	No	Battery undervoltage alarm.
【02】	BatOverCurrSw	Yes	Battery discharge average current overcurrent (software protection).
【03】	BatOpen	Yes	Battery not-connected alarm.
【04】	BatLowEod	Yes	Battery undervoltage stop discharge alarm.
【05】	BatOverCurrHw	Yes	Battery overcurrent (hardware protection).
【06】	BatOverVolt	Yes	Charging overvoltage protection.
【07】	BusOverVoltHw	Yes	Bus overvoltage (hardware protection).
【08】	BusOverVoltSw	Yes	Bus overvoltage (software protection).
【09】	PvVoltHigh	No	PV overvoltage protection.
【10】	PvOCSw	No	Boost overcurrent (software protection).
【11】	PvOCHw	No	Boost overcurrent (hardware protection).
【12】	SpiCommErr	Yes	SPI communication fault of master and slave chips
【13】	OverloadBypass	Yes	Bypass overload protection.
【14】	OverloadInverter	Yes	Inverter overload protection.
【15】	AcOverCurrHw	Yes	Inverter overcurrent (hardware protection).

【16】	AuxDspReqOff PWM	Yes	Slave chip OFF request fault
【17】	InvShort	Yes	Inverter short-circuit protection.
【18】	Bussoftfailed	Yes	Bus soft-start failure
【19】	OverTemperMppt	No	Buck heat sink over temperature protection.
【20】	OverTemperInv	Yes	Inverter AC output with load or AC charging radiator over-temperature protection.
【21】	FanFail	Yes	Fan blockage or failure fault.
【22】	EEPROM	Yes	Memory failure.
【23】	ModelNumErr	Yes	Model setting error.
【24】	Busdiff	Yes	Positive and negative bus voltage imbalance
【25】	BusShort	Yes	Bus short-circuit
【26】	RlyShort	Yes	Inverted AC Output Backfills to Bypass AC Input.
【27】	LinePhaselose	Yes	Grid input phase lose
【28】	LinePhaseErr	Yes	Grid input phase error
【29】	BusVoltLow	Yes	Internal battery boost circuit failure.
【30】	BatCapacityLow1	No	Alarm given when battery capacity rate is lower than 10% (setting BMS to enable validity).
【31】	BatCapacityLow2	No	Alarm given when battery capacity rate is lower than 5% (setting BMS to enable validity).
【32】	BatCapacityLowStop	Yes	Inverter stops when battery capacity is low (setting BMS to enable validity).

【33】	ControlCanFault	Yes	Control CAN fault in parallel operation.
【34】	CanCommFault	Yes	CAN communication fault in parallel operation.
【35】	ParaAddrErr	Yes	Parallel ID (communication address) setting error.
【36】	Balance currentOC	Yes	Balance bridge arm overcurrent failure
【37】	ParaShareCurrErr	Yes	Parallel current sharing fault .
【38】	ParaBattVoltDiff	Yes	Large battery voltage difference in parallel mode.
【39】	ParaAcSrcDiff	Yes	Inconsistent AC input source in parallel mode.
【40】	ParaHwSynErr	Yes	Hardware synchronization signal error in parallel mode.
【41】	InvDcVoltErr	Yes	Inverter DC voltage error.
【42】	SysFwVersionDiff	Yes	Inconsistent system firmware version in parallel mode.
【43】	ParaLineContErr	Yes	Parallel line connection error in parallel mode.
【44】	Serial number error	Yes	No serial number set at factory.
【45】	Error setting of split-phase mode	Yes	Item "Parallel" setting error.
【56】	Low insulation resistance fault	No	PV1+, PV2+ and PV- abnormally low impedance to ground.
【57】	Leakage current overload fault	Yes	System leakage current exceeds limit.
【58】	BMS communication error	No	Check whether the communication line is connected correctly and whether [33] is set to the corresponding lithium battery communication protocol.

【60】	BMS battery low temperature alarm	No	BMS alarm battery low temperature.
【61】	BMS battery over temperature alarm	No	BMS alarm battery over temperature.
【62】	BMS battery over current alarm	No	BMS alarm battery over current.
【63】	BMS battery undervoltage alarm	No	BMS alarm low battery.

7.2 Troubleshooting

Fault Code	Meaning	Causes	Remedy
/	No screen display	No power input, or the switch on the bottom of the unit is not switched on.	Check whether the battery air circuit-breaker or PV air circuit-breaker is turned on. Check if the switch is "ON". Press any button on the screen to exit the screen sleep mode.
01	Battery under-voltage	The battery voltage is lower than the value set in parameter [14].	Charge the battery and wait until the battery voltage is higher than the value set in parameter [14].
03	Battery not connected	The battery is not connected, or the BMS is in discharge protection state.	Check that the battery is reliably connected. Check that the battery circuit-breaker is off. Ensure that the BMS is able to communicate properly.
04	Battery over-discharge	The battery voltage is lower than the value set in parameter [12].	Manual reset: Switch off and restart. Automatic reset: Charge the battery so that the battery voltage is higher than the value set in parameter item [35].
06	Battery over-voltage when charging	Battery is in over-voltage condition.	Manually power off and restart. Check to see if the battery voltage exceeds the limit. If it exceeds, the battery needs to be discharged until the voltage is below the battery over-voltage recovery point.
13	Bypass over-load (software detection)	Bypass output power or output current over-load for a period of time.	Reduce the load power and restart the device. Please refer to item 11 of the protection function for more details.
14	Inverter over-load (software detection)	Inverter output power or output current over-load for a period of time.	
19	Heat sink of PV input over-temperature (software detection)	Heat sink of PV input temperature exceeds 90°C for 3s.	Normal charging and discharging is resumed when the temperature of the heat sink cools below the over-temperature recovery temperature.
20	Heat sink of inverter output over-temperature (software detection)	Heat sink of inverter output temperature exceeds 90°C for 3s.	
21	Fan failure	Hardware detects fan failure.	Manually toggle the fan after powering off the machine to check for foreign matter blockage.

Fault Code	Meaning	Causes	Remedy
26	AC input relay short-circuit	Relay for AC input sticking.	Manually turn off and restart the machine, if the fault reappears after restarting, you need to contact the after-sales service to repair the machine.
28	Utility input phase fault	AC input phase does not match AC output phase.	Make sure that the phase of the AC input is the same as the phase of the AC output.

**NOTICE**

If you encounter product faults that cannot be solved by the methods in the above table, please contact our after-sales service department for technical support and do not disassemble the equipment by yourself.

8. Protection and Maintenance

8.1 Protection function

No	Protection functions	Description
1	PV input current / power limiting protection	When the charging current or power of the PV array configured exceeds the PV input rated value, the inverter will limit the input power and charge at the rated.
2	PV input over-voltage	If the PV voltage exceeds the maximum value allowed by the hardware, the machine reports a fault and stops PV boosting to output a sinusoidal AC waveform.
3	Anti-reverse charge protection at night	At night, the battery will be prevented from discharging to the PV module because the battery voltage is greater than the PV module voltage.
4	AC input over-voltage protection	When the mains voltage of per phase exceeds 280Vac, the mains charging will be stopped and will switch to inverter output.
5	AC input under-voltage protection	When the mains voltage of per phase falls below 170Vac, the mains charging will be stopped and will switch to inverter output.
6	Battery over-voltage protection	When the battery voltage reaches the over-voltage disconnection voltage point, it will automatically stop the PV and mains charging of the battery to prevent over-charging and damage to the battery.
7	Battery under-voltage protection	When the battery voltage reaches the low-voltage disconnection voltage point, it will automatically stop discharging the battery to prevent the battery from being over-discharged and damaged.
8	Battery over-current protection	When the battery current exceeds the range allowed by hardware, the machine will turn off output and stop discharging the battery.
9	AC output short-circuit protection	When a short-circuit fault occurs at the load, the AC output voltage will be switched off immediately and output again after 1 min. If the output load is still short-circuited after 3 attempts, short-circuit fault of the load must be eliminated first and then manually re-powered in order to restore the normal output.
10	Heat sink over-temperature protection	When the internal temperature of the inverter is too high, the inverter will stop charging and discharging; when the temperature returns to normal, the inverter will resume charging and discharging.
11	Inverter over-load protection	After triggering the overload protection, the inverter will resume output after 3 minutes, 5 consecutive overloads will switch off the output until the inverter restarts. (102%<load<110%) : error, output switched off after 5 minutes. (110%<load<125%) : error reported and output switched off after 10s.

		(>125% load): error reported and output switched off after 5s.
12	AC output reverse	Prevents backfeeding of battery inverter AC to bypass AC inputs.
13	Bypass over-current protection	Built-in AC input overcurrent protection circuit breaker.
14	Bypass phase inconsistency protection	When the phase of the two bypass inputs is different from the phase of the inverter phase split, the machine will prohibit cutting into the bypass to prevent the load from dropping out or short-circuiting when cutting into the bypass.

8.2 Maintenance

To maintain optimum long-lasting working performance, it is recommended that the following items be checked twice a year.

1. Ensure that the airflow around the inverter is not blocked and remove any dirt or debris from the radiator.
2. Check that all exposed conductors are not damaged by sunlight, friction with other surrounding objects, dry rot, insect or rodent damage, etc. The conductors need to be repaired or replaced if necessary.
3. Verify that the indications and displays are consistent with the operation of the equipment, note any faults or incorrect displays and take corrective action if necessary.
4. Check all terminals for signs of corrosion, insulation damage, high temperatures or burning/discolouration and tighten terminal screws.
5. Check for dirt, nesting insects and corrosion, clean as required, clean insect screens regularly.
6. If the lightning arrester has failed, replace the failed arrester in time to prevent lightning damage to the inverter or other equipment of the user.

**DANGER**

- Make sure that the inverter is disconnected from all power sources and that the capacitors are fully discharged before carrying out any checks or operations to avoid the risk of electric shock.

The Company shall not be liable for damage caused by:

1. Damage caused by improper use or use in a wrong location.
2. PV modules with an open-circuit voltage exceeding the maximum permissible voltage.
3. Damage caused by the operating temperature exceeding the restricted operating temperature range.
4. Dismantling and repair of the inverter by unauthorised persons.
5. Damage caused by force majeure: damage during transport or handling of the inverter.

9. Datasheet

MODEL	SPI-8K-H3P	SPI-10K-H3P	SPI-12K-H3P	Can Be Set
INVERTER OUTPUT				
Rated Output Power	8,000W	10,000W	12000W	
Max. Peak Power	16,000W	20,000W	24000W	
Rated Output Voltage	230/400Vac (three-phase)			√
Capacity of Motor Load	5HP	6HP	6HP	
Rated Frequency	50/60Hz			√
Output Waveform	pure sine wave			
Switching Time	10ms (typical)			
Number of parallel	6			
Overload Protection	<p>After triggering the overload protection, the inverter will resume output after 3 minutes, 5 consecutive overloads will shut down the output until the inverter is restarted.</p> <p>(102%<load<110%) : alarm, output shut down after 5 minutes.</p> <p>(110%<load<125%) : alarm, output shut down after 10s.</p> <p>(>125% load) : alarm, output shut down after 5s.</p>			
BATTERY				
Battery Types	Li-ion / Lead-Acid / User Defined			√
Rated Battery Voltage	48Vdc			
Voltage Range	40-60Vdc			√
Max. Utility /Generator Charging Current	100A	120A	120A	√
Max. Hybrid Charging Current	180A	220A	260A	√
PV INPUT				
No. of MPPT	2			
Max. Input Power	6000W/6000W	7500W/7500W	9000W/9000W	
Max. Input Current	22/22A			
Max. Open-circuit Voltage	800Vdc/800Vdc			
MPPT Operating Voltage Range	200-650Vdc/200-650Vdc			
Utility / GENERATOR INPUT				
Input Voltage Range	phase voltage 170~280V, line voltage 305~485V			
Input Frequency Range	50 / 60Hz			
Bypass Overload phase Current	23.2A	29A	35A	
EFFICIENCY				
MPPT Tracking Efficiency	99.9%			
Max. Battery Inverter Efficiency	≥92%			
European Efficiency	97.2%	97.5%	97.5%	

GENERAL		
Dimensions	620*445*130mm (2.03*1.46*0.43ft)	
Weight	27kg (59.52lb)	
Protection Degree	IP20, indoor only	
Ambient Temp	-10~55°C, >45°C derated	
Noise	<60dB	
Self-consumption	<130w	
Cooling Method	air cooling	
COMMUNICATION		
Internal Interface	RS485 / CAN / USB / Dry contact	√
External Module (optional)	Wi-Fi / GPRS	√
CERTIFICATION		
Safety	IEC62109-1, IEC62109-2	
EMC	EN61000-6-1, EN61000-6-3, FCC 15 class B	
RoHS	Yes	