

# USER MANUAL

PLEASE READ THE INSTRUCTIONS CAREFULLY BEFORE RIDING

# *INRYID*



 TEMPERATURE CONTROL

 NFC

 DUAL MOTOR

 DISC BRAKE SYSTEM

# CONTENT

GENERAL INFORMATION .....	1
MUKUTA RANGE-CONTROL LAYOUT,FUNCTIONS AND SPECIFICATIONS .....	2~3
INTELLIGENT TEMPERATURE CONTROL MANAGEMENT SYSTEM .....	4~5
MUKUTA DISPLAY OPERATION AND PROGRAMMING .....	6~15
FOLDING HANDLE BARS .....	16~17
BATTERY AND CHARGING .....	18~19
PRE RIDE CHECKS .....	20
WARNING .....	21
LIMITED WARRANTY .....	22~23
ERROR CODES .....	24~25
INCLUDED IN THE BOX .....	26
AFTER-SALES SERVICE .....	27~28

# READ THIS MANUAL BEFORE USING

## IMPORTANT INFORMATION

### WHY IS IT NECESSARY TO READ THIS MANUAL BEFORE OPERATING?

This manual was written to help you understand the proper use and maintenance of the iENYRID line of Electric Scooter.

It is important to understand the functions and features of the new iENYRID before operating it as it will allow you to enjoy the most of it from the first and every ride.

It is also important for you to note that the first trial of the iENYRID should be in a remote area where obstacles are minimal to none.

The iENYRID unit will require some adjustments and break-in period for all moving parts to adjust themselves into the correct position.

**BEFORE RIDING:** Please ensure that the folding mechanism is firmly locked in place and that the safety lock is engaged.



## DISCLAIMER & WARNING

The product and its brand iENYRID is not liable for any accidental damages related to the usage of this product.

### **WARNING!**

The responsibility for iENYRID maintenance is yours! Proper and frequent maintenance will reduce risks of injuries.

- ALWAYS WEAR A HELMET WHEN RIDING
- ALWAYS FOLLOW LOCAL LAWS AND REGULATIONS
- NEVER RIDE SCOOTER IN POOR VISIBILITY
- DO NOT DO STUNTS, WHEELIES or JUMPS IF YOU DO NOT HAVE THE PROPER SAFETY GEARS.

# iENYRID



- MAX SPEED: 25-60KM/H
- ELECTRONIC BRAKE + MECH DISC BRAKE SYSTEM
- TURN SIGNAL



- CONTROLLER: 52 V /25A\*2
- MAX RANGE: 50-70KM
- BATTERY: 52V/20AH



- NFC KEY LOCK
- ELECTRONIC HORN
- 4.5 INCH LARGE SCREEN LCD



- FOLDING SWITCH



- 1200W REAR MOTOR
- REAR SUSPENSION
- PNEUMATIC TYRE 10×3INCH
- DISC BRAKE SYSTEM



- DISC BRAKE SYSTEM
- FRONT SUSPENSION



Model	iE-ES30
Battery	52V/20AH
Tire	10×3 inch
Brakes	Electric Brake+Front and rear disc brake system
Max Range(Single Motor)	50-70KM
Max Speed	25-60KM/H
Weight	Net weight: 30KG      Gross weight: 35.5KG
Packing Size	135*28*60cm
Suspension	FRONT-REAR SUSPENSION
Motor Power	52V 1200W×2 BRUSHLESS MOTORS
Controller	52V/25A*2
Max Load	130KG



Maximum load and speed may vary depending on the rider's weight, riding style and terrain.



## INTELLIGENT TEMPERATURE CONTROL MANAGEMENT SYSTEM



Intelligent overheat protection

The intelligent temperature control system will reduce the output current to protect the controller when it detects that the temperature of the controller is too high. At this time, you should stop driving vigorously. If you continue to ride at high power consumption, the intelligent temperature control system will cut off the power supply to the motor. Conditions that reduce current and cut power to the motor will recover automatically after detecting the temperature drop.



## iENYRID series electric scooter intelligent temperature control system

Model	iENYRID ES30		
Temperature protection (Current-limiting) (According to the local topography $\pm 5^{\circ}\text{C}$ )	90 °C	Remove thermal protection	85 °C
Temperature protection (Cut power to the motor) (According to local climatic conditions $\pm 5\text{s}$ )	110 °C	Remove thermal protection (Motor recovery, limiting current until 85°C)	105 °C



## Basic operation:

### 1、 Function

#### 1. Displayed content

Speedometer / Voltage level / Odometer / Trip meter / Battery level / Cruise-control active light / Gear indicator / Fault warning light

#### 2. All content on display(power on within 1 second)

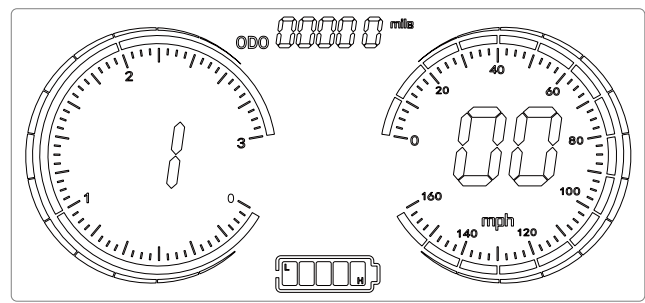



### 3.1 Speed display area

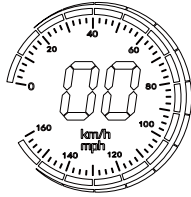

Unit: MPH/KMH

The speed signal is taken from the Hall signal inside the motor. Sent to controller by controller (Time of single Hall period, unit: 1MS). The display calculate the true speed based on wheel diameter and signal data calculate the true speed (The motor Holzer also needs to set the number of magnetic steel)

### 3.2 Vehicle power gear adjustment,



0-3 digital display;

### 3.3 vehicle status display area



Brake power off reminder



The headlight turns on the prompt;



Constant speed cruise hint;



Communication fault prompt;

Display P-Codes(programming codes)

To access this menu, long-press  and . Use  button to scroll through P-codes,  and  to change parameterd

P01: Backlight brightness:The 1 level is the darkest, Level 3 brightest; Default: 3

P02: Mileage: unit,0: KM; 1: MILE; Default: MILE

P03: Voltage level: 24V, 36V, 48V, 52V, 60V, 72V, Default:52V

P04: Dormancy time:0 means no dormancy;Other numbers are dormant time.The range is 1-60 minute.Default:5

P05: Reserve

P06: Wheel diameter: The unit is inch. The accuracy is 0.1; Default:10.0

P07: Speed measuring magnetic steel number.The range is 0-255. Default:28

P08: Rate-limiting: The range is 0-100km/h.Default: 100

P09: Zero start- no zero start setting; 0 means zero start.1means no Zero start.Default: 0

P10:Reserve

P11: EABS switch choose.The range is 1-5.0 means closing.1 means weakest. 5 means strongest.

P12: Soft and hard start strength.The range is 1-5. The softest is 1.The hardest is 5.Default: 5

P13: Reserve

P14: Reserve

P15: Controller under-voltage

P16: ODO Zero setting: keep pressing "+" for 5 seconds,ODO will zero clearing.

P17: When it shows 0,it can not use cruise.When it shows 1,it can use cruise.Default:0













P18: Bind and unbind NFC CARDS.Long press "+" to build the binding, long press "-" to build the unbinding

P19: Reserve

P20: Communication protocol is defaults 4.It can not change.

## 2、 Introduction of buttons and interfaces



1. When it is shutdown, long-press hold button continuously for 2s  to turn on the power. When it is power on ,It can change interface between the ODO、 TRIP、 VOL, by pressing  for short time.
2. When it is power on, long-press hold button continuously for 2s  to turn off,press   to change gear.
3. Long-press  and  to enter P-code menu - refer to functions on page 8.  
Enter the menu setting interface, press  or  to increase or decrease the value , after the modification is finished;Press  to switch to the next parameter and save the value of the previous parameter;After parameter modification, long press  +  again to exit the setting interface, or wait for 8 seconds for automatic exit and save parameters.

### 3、 Card binding instructions

1.The instrument is not bound to ID card:

After starting up, the LCD displays the normal contents, At this time, the meter can directly enter the working state.

The diagram below:



2.How to bind ID card:

CARDS are bound by factory default

Late setting: When using mobile phone or NFC functional card binding, refer to the following methods

Long press  for 5 seconds to display B 0. At this time, the ID card is close to the card swiping area and B 1 is displayed, indicating that the card is tied successfully.

Press  for 5 seconds to display C 0. At this time, all ID CARDS have been unbound.

3. The NFC display has been bound with NFC card: after starting up, the LCD screen is displayed as CARD. At this time, the motor does not work. The diagram below:



**Note:** Due to the upgrade of the company's products, some of the displayed contents of the products you get may be different from the instructions, but it will not affect your normal use.

If the NFC cards are lost accidentally, you can try to contact the local agents. (each E-Scooter is equipped with 3 keys).

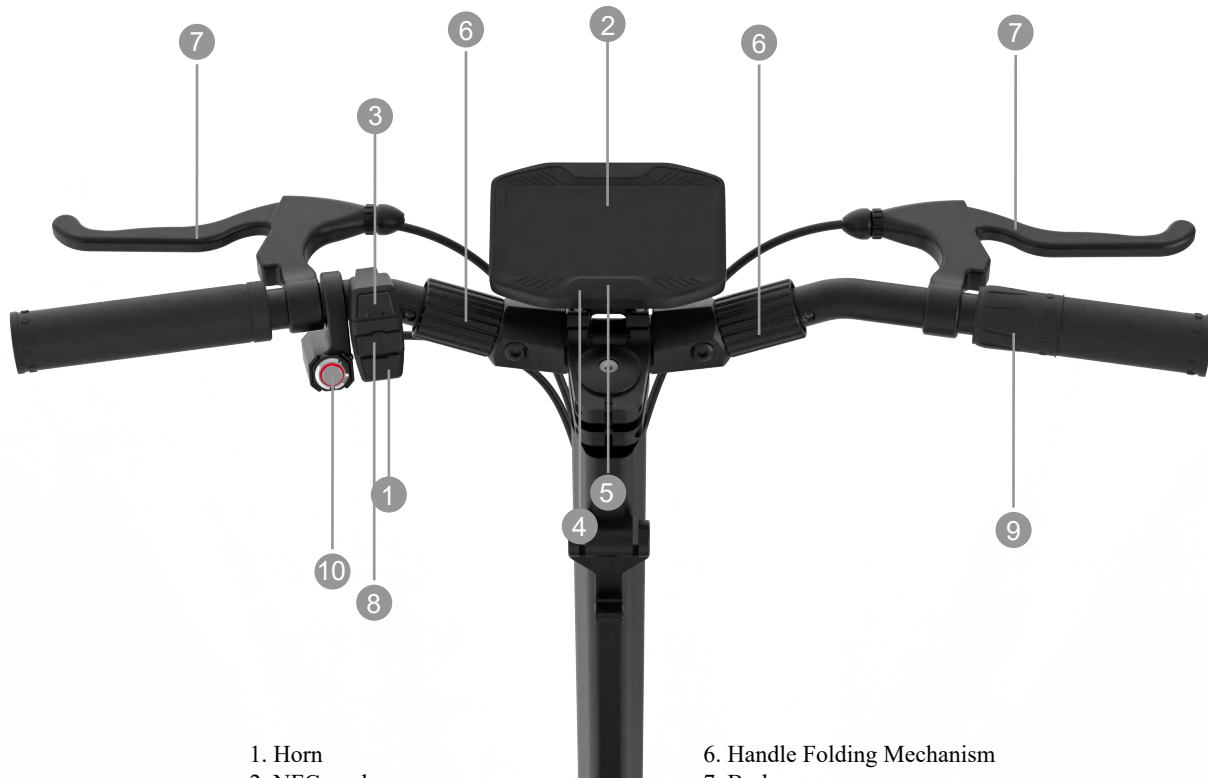

1. Horn
2. NFC card area
3. Downshift button/Upshift button
4. Turn on the light
5. Power Switch

6. Handle Folding Mechanism
7. Brake
8. Turn signal
9. Throttle
10. Single motor dual motor switching

Power On/Off	Long-press the power button [5] for 2 seconds to turn on/off the scooter, then use NFC card to activate it.The scooter turns off automatically if not used for 90 seconds
Speed Control	Press the [3] button to cycle through the three different speed levels 1 to 3.Use the throttle to control the speed within each speed level.
Headlight	While power is on, Long-press(press and hold for 2s) [4] button to turn on or off headlight.
Mileage & Other data	While stationary, and with the power on, Long-press(press and hold for 2s) and release th [5] button to cycle through the following data: ODO (lifetime mileage),TRIP mileage, VOLTAGE level, ERROR CODE.



## TURNING IT ON

Press the  for 3 seconds and wait to be prompted for the Token (Card).

Tap the Token (Card)  to the IR reader NFC

---

## PSETTING

Press and hold both  and  simultaneously for 3 seconds to access the P Setting interface.

---

## CHANGING OF SPEED

Press the  once to toggle between increasing between 1 to 3.

Function is to limit max limit, 3 being the max speed able to achieve.



Downshift button/Upshift button

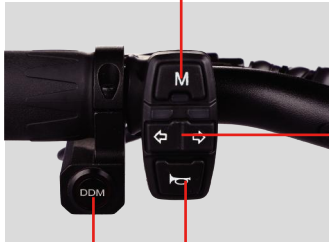

DDM HORN

BUTTON FOR TURN  
SIGNAL LIGHTS (BLINKERS)

Press the



Mode button to cycle through the three different speed levels 1 to 3.

Press the



left turn button, and the left turn light will flash. When you're done turning, press the button again to turn off the light. Please do not press the two turn buttons at the same time, otherwise the two turn signals will flash at the same time.

Press the



horn button once to activate the horn. Button are able to be holdon or to press once.

Press the



Press the once to activate the Dual Drive Motor function. Pressing it again will allow Single Drive Motor Function.

1

Turn the handle screw anti - clockwise to loose the mechanism



2

Once loosen, pull the screw catch away from each other



3

Simultaneously fold the handle bar down



4

Loosen the folding buckle



5

Take out the hook



6

Fold down the main pole



7

Snap the handlebar's safety hook into the rear shim



### BATTERY

- Do not operate the scooter while charging
- Do not store the scooter over a long period of time with an almost empty battery.
- From time to time, discharge the battery by riding. Have the battery recharge again and make sure to not leave battery fully empty.

### DO NOT DO ANY CHARGING IF THE BOARD:

- is broken
- emits an unusual odour or colorless liquid.
- the bottom of the deck or it as a whole gets into excessive heating
- leakage is present.

Avoid contacting with substance or meddling with a bloated battery. Keep the battery away from children, pets or direct heat. Exposure to the battery voltage may cause death or serious injury.

The use, storage or charging of the iENYRID battery outside specified limits may result in the annulment of the warranty, battery damage and an effective battery charging,



It is important to fully charge the battery before your first use of the scooter.

## First Charge

---

Your scooter's battery comes with these built-in features:

1. Balanced charging protection: During charging, the battery automatically balances the voltage among the internal cells to protect each cell.
  2. Over-charging protection: The battery stops charging automatically when full to protect against damage.
  3. Over current protection: The battery automatically stops charging if the voltage is higher than prescribed voltage to protect the battery.
  4. Over discharging protection: The battery automatically stops discharging when its voltage drops below Under voltage value to protect the battery.
  5. Short-circuit protection: the battery automatically stops output in the case of a short-circuit.
- 

## How to charge

1. Ensure that scooter is TURNED OFF. Connect external power charger to scooter.
2. Connect charger to electrical outlet, then turn on the power of electrical outlet.
3. Do not charge the batteries in temperatures below 5 °C or above 40 °C. The battery may stop the charging process.
4. Charging Light **RED** - Battery is charging.  
Charging Light **Green** - Battery is fully charged.

# PRE RIDE CHECKS

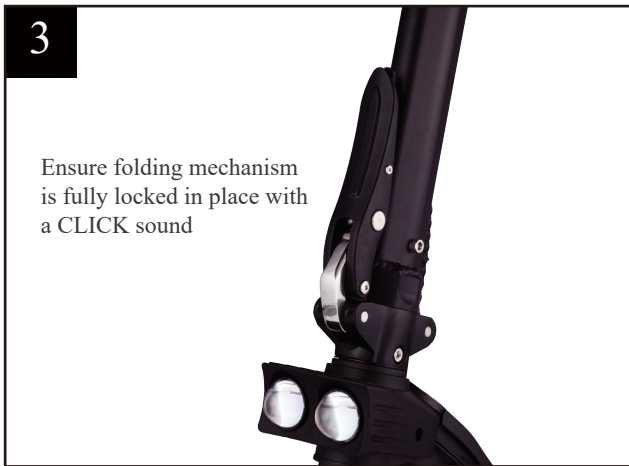



## WARNING!

Certain countries or regions require safety devices or gear. It is your responsibility to know the state laws and follow them. However, we strongly recommend safety gears to be worn before operating the device.

TIRE AIR PRESSURE: THE TIRE IS PRESSURIZED TO THE STANDARD VALUE ON THE TIRE

### SAFETY GEAR

Helmet: Most common and serious injuries from riding are head injuries. This can be prevented by wearing a helmet. You must wear a helmet when riding the iENYRID. The helmet must be worn according to their instruction.

### MECHANICAL SAFETY

Before using the iENYRID:

- 1) Always perform a visual inspection of all screws and nuts are tight and in place. If anything is amiss or missing and you are unsure, please bring it back to the authorized distributor.
- 2) Check the tyres and wheels and that it is not showing signs of wear and tear; not in need of replacement. Always ensure that the brake mechanism is not touching the wheels and allows free spinning.
- 3) Always perform mechanical checks of brakes and other parts of the scooter that allows visibility, safety and functionality of the scooter to be.

BY USING THIS PRODUCT YOU AGREE TO THIS LIMITED WARRANTY. PLEASE READ THIS LIMITED WARRANTY CAREFULLY.

To benefit from the limited warranty, the customer is advised to read iENYRID Warranty terms together with the “care and maintenance” sections provided in the user manual. This limited warranty applies to the extent permitted by law and unless restricted or prohibited by law.

#### Limited Warranty Details

1. iENYRID warrants that iENYRID scooter products (“Products” or “Product”), are free from defects in material and workmanship, according to the following terms and conditions:
2. This Limited Warranty extends to the original purchaser of the Product warranted under this warranty and to each transferee of the Product during the first \_\_\_\_\_ months beginning on (date) \_\_\_\_\_ as stated below (“Warranty Period”).

This Limited Warranty covers the Product and each of its following component parts (“Components”) only:

- a. Hub motor;
  - b. Battery packs (except if battery was short circuited or seals of the battery enclosure or cells were broken or were tempered or the battery was used in equipment other than its intended use);
  - c. Controller;
  - d. NFC Display;
  - e. Charger unit;
  - f. All other electrical wiring and components.
3. During the Warranty Period, iENYRID or its authorized service centres will repair or replace, at iENYRID’s option and without costs to the customer, any defective Components with new or factory rebuilt replacement items, and return the Products to the customer in working condition, provided that the terms and conditions of this Limited Warranty are met. All defective Products or Components that have been replaced shall become the properties of iENYRID.
  4. Products and/or Components that have been repaired or replaced pursuant to the paragraph above will be covered by this Limited Warranty for the balance of the Warranty Period.
  5. This Limited Warranty will only be effective when presented together, to either iENYRID or its authorised centres, with proof of date and place of purchase of Products such as the purchase receipt.

What this Limited Warranty does not cover:

1. Products used for commercial purpose(s) including but not limited to leasing/hiring, use in competitions etc
2. Any logistical costs of returning the Product to iENYRID or its authorised service centres for servicing or the cost of returning the Product to the customer after servicing.
3. Defects or damages resulting from use of the Product(s) other than its normal and customary manner as stated in the user manuals accompanying the Products.
4. Defects or damages from improper storage, exposure to moisture or dampness, modifications, connections, repairs (except as carried out by iENYRID or its authorised centres), misuse, neglect, abuse, accident, alteration, improper installation, or other acts which are not the fault of iENYRID, including damage caused by dropping, blown fuses, spills of food or liquid.
5. Defects or malfunctions of the product not notified by customer during the Warranty Period.
6. Products which have had their serial numbers removed or tampered with.
7. This Limited Warranty is in lieu of all other warranties, express or implied either in fact or by operations of law, statutory or otherwise, including, but not limited to any implied warranty of marketability or fitness for a particular use.



**Disclaimer:**

1. The customer understands the risk of serious injury or death in the operation of such products and shall agree to take the **necessary precautions** and exercise **good judgement** to avoid hazards and dangerous situations which may result in serious injury or death.
2. The customer shall agree to indemnify and hold harmless iENYRID from all injuries or death arising from the operation of the product.
3. The use of safety and protective gear such as bicycle helmets is strongly encouraged. And so is the use of Good Judgement.
4. The customer is advised to take the following precautions:
  - a. Do not ride on wet ground or in heavy rain;
  - b. Take corners slowly and look out for pedestrians;
  - c. Avoid potholes, kerbs and debris on the ground;
  - d. Keep tires pumped to the specified pressure;
  - e. Dismount in places with heavy human traffic and push the scooter manually;
  - f. Service the product every 3 months on regular usage, 6 months for non-frequent usage;
  - g. Do not use product on public roads and respect local road regulations.

**How to request service under this Limited Warranty:**

To obtain performance of iENYRID to repair and/or replace the Product or its Components under this Limited Warranty, the customer must, during the Warranty Period:

1. Bring this Limited Warranty, proof of purchase and the Product to iENYRID.
2. Provide iENYRID with a written description of the problem.

The average repair time is 1 to 3 days, not including shipping time to and from our service centre.

This warranty does not cover the shipping costs associated with the transportation of the scooter to and from our service centre, and a fee will be charged for return shipping or pick up and delivery service.

**What can the consumer do in case of a dispute with iENYRID**

The consumer and iENYRID agree that in the event of a dispute arising from the material and workmanship of the Product; or from this Limited Warranty, parties will attempt to first resolve the matter by negotiating in good faith.

# ERROR CODE

Error Code	Fault	Diagnostic Step	Resolution
00	Normal Status	Normally ok; Turn off and on the scooter to see if the error persists	Normally ok
02	Brake	Check brake lever on handlebar and see if brake springs back all the way	Give the brake lever a few hard presses to ensure that it is not stuck; If jammed, then unclog the source of the jam
		Check brake caliper to see if the brake line is springing back to original position	If brake caliper is not springing back, spray some WD40 to make sure it springs back to original position
06	Battery Undervoltage	Check LCD setting P03 and P15; Give battery a full charge to see if issue persists	P03 should be in accordance to the voltage specified in the user manual. P15 should be the specified voltage - 42V
07	Motor Fault	Unplug and plug motor connector back in to see if issue persists	If problem is resolved, then make sure connector is pushed in all the way.
		If issue persists; check motor wire and connector pins to see if there are any issues	Either replace the motor or replace motor wire.



Brake Sensor Activated



# ERROR CODES

Error Code	Fault	Diagnostic Step	Resolution
08	Turnstile Fault	Check if back screw or magnet has come loose in the throttle/LCD	Tighten back screw or replace magnet in the throttle
09	Controller Fault	Replace controller	Replace controller
10	Communication Receiving Fault	Unplug and plug in LCD connector and see if issue persists; IF issue persists, then wiggle the LCD wire in different directions to see if problem persists	Change of wiring hardness from LCD to controller might be needed if the issue persists
11	Communication Transmission Fault	Unplug and plug in controller connector and see if issue persists; IF issue persists, then wiggle the LCD wire in different directions to see if problem persists	Change of wiring hardness from LCD to controller might be needed if the issue persists



**Brake Sensor Activated**



# Included in the box

SERIAL NUMBER	ITEM	QUANTITY
1	Charger	1
2	Combination tool	1
3	Instruction book	1
4	NFC card	3
5	Reflective sticker	4

# After-sales service

For any problem listed in following table,our distributor will provide perfect after-sales service within the scope of warranty.

Part	Quality issue	Warranty period	Remarks
Motor	Seriously broken rubber wheel hub,faulty motor	12 months	Free repair
Accelerator	Unable to use with normal conditions (except damage caused by impact)	3 months	Free repair
Controller	Fault during normal use	12 months	Free repair
Charger	Fault during normal use	3 months	Free repair
Lithium battery	No output during normal use	12 months	Free repair
Framework	Deformation or fracture during normal use	6 months	Free repair

## Attentions for warranty

Faults caused by any of following causes are not within the scope of warranty:

1. Failed to maintain according to this user manual;
2. Damage caused by misuse, traffic accident or accidental collision;
3. Damage caused by riding on abnormal roads or accidental collision;
4. Please do not expose this product under blazing sun or outdoor for along time,as that will speed up the aging process of the product and cause malfunction.
- 5.Quick aging and malfunction of the product caused by dangerous play with the electric scooter,such as acrobatic play;
6. Damage of the vehicle caused by natural disaster or irresistible force;

Note:Pleas efer to the our website for updated information about after-sales,replacement,payable and free warranty.

## PLEASE ALWAYS KEEP THE BOX FOR ANY POSSIBLE FUTURE AFTER-SALES SHIPMENT.

Warranty Card			
Dear user, Thanks for using our electric scooter. Please fill in the form below clearly for sake of better after-sale services.			
User	Name		Workplace
	TEL		
	ADD		
Date of Purchase		Serial number	
Model		VIN	
Invoice Number		Battery serial number	
Distributor	Name		
	Contact		
Note			

### Shenzhen Tianshengle Robot Co., Ltd.

 Address: Room505, 5th Floor, Liuwei Business Center, Yangmei Longjing Road, Longgang District, Shenzhen city, China

 WhatsApp: +8613612953725

 Customer support: support@ienyrid.com

 Official website: www.ienyrid.com

