 <p>Yarn Bobbin (convex shaft type, 350*271mm) 纱线盘头 凸轴式350X271mm</p>	 <p>QLQ-4ZTIM/QLQ-6ZTIM Automatic Zipper Tape Ironing Machine (4 tapes/6 tapes, one chamber) 全自动拉链布带烫带机(4带/6带,单箱)</p>	 <p>QLQ-ZTIM-2 Automatic Zipper Tape Ironing Machine (new type, 4 tapes, two chambers) 全自动拉链布带烫带机(新款,4带,两箱)</p>
 <p>Yarn Bobbin (bearing type, 355*255mm) 纱线盘头 穿心式355X255mm</p>		
 <p>QLQ-SFM-1 Tape/Zipper Shape Fixing Machine (before dyeing, there are 3 models for choosing) 1- only for tape 2-only for zipper 3-for both tape & zipper 此机有三款可供选择 1-布带染色前除油定型机(6带) 2-拉链染色前除油定型机(6带) 3-拉链与布带可共用的前定型机</p>		 <p>QLQ-SFM-2 Tape/Zipper Shape Fixing Machine (after dyeing, there are 3 models for choosing) 此机有三款可供选择 1-全自动布带染色后定型机(滚筒式) 2-尼龙拉链染色后定型机 3-布带&尼龙拉链染色后定型机</p>

12.3 Nylon Long-chain Zipper Machine

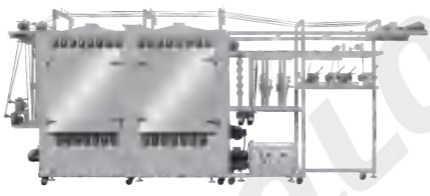

尼龙码装拉链机器

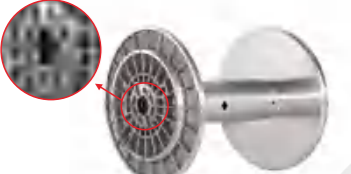

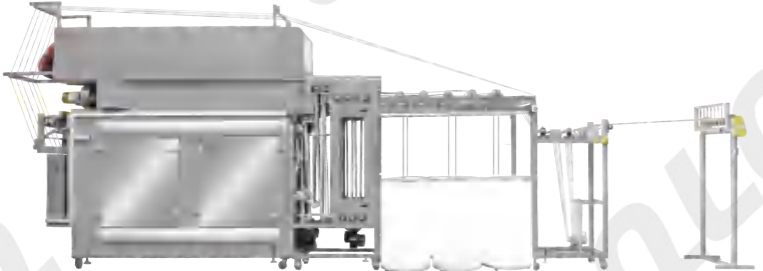
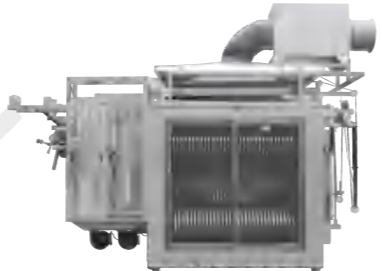



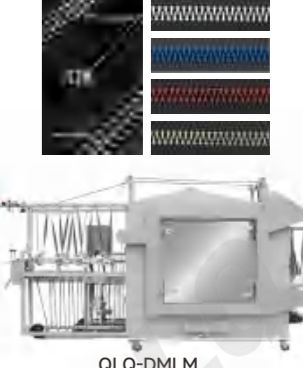

 <p>QLQ-MMM Monofilament Manufacturing Machine 单丝制造机</p>		
 <p>QLQ-CFM-1 Automatic Nylon Zipper Coil Forming Machine (small bobbin) 全自动尼龙拉链齿成型机(小盘头)</p>	 <p>QLQ-CFM-2 Automatic Nylon Zipper Coil Forming Machine (big bobbin) 全自动尼龙拉链齿成型机(大盘头)</p>	 <p>QLQ-CFM-3 Automatic Nylon Zipper Coil Forming Machine (horizontal type) 全自动尼龙拉链齿成型机(卧式)</p>
 <p>QLQ-NLSM Automatic Zipper Sewing Machine (this photo shows 2 sets) 全自动拉链缝合机</p>	 <p>QLQ-SDTM Sample Dyeing Test Machine 小样染色测试机</p>	 <p>QLQ-BWMD Automatic Tape/Nylon Zipper Bobbin Winding Machine (for dyeing machine) 全自动布带/尼龙拉链绕盘头机(配套染缸)</p>

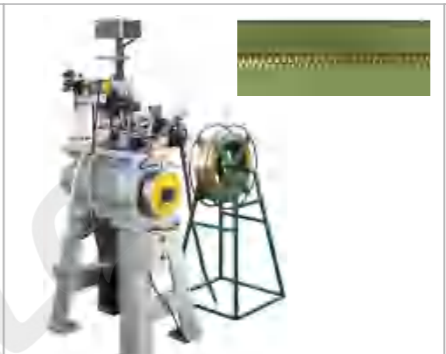
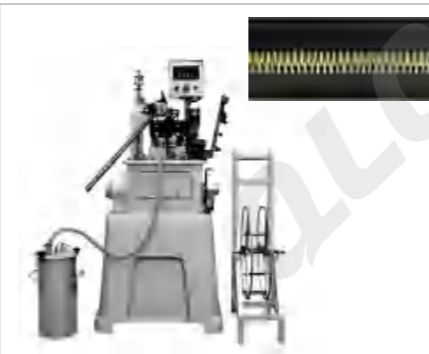





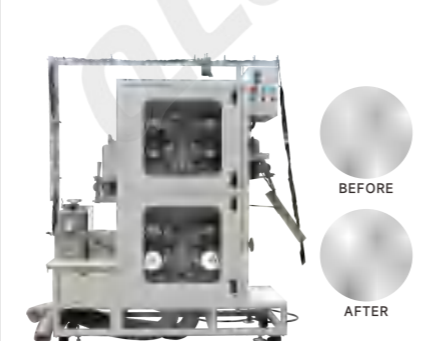
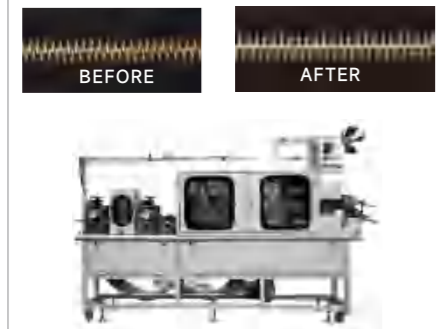

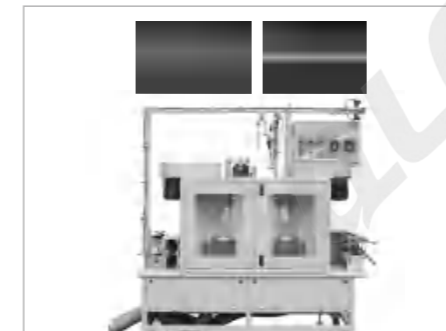

 <p>QLQ-ZDM Dyeing Machine 染缸</p>	 <p>Bobbin of Dyeing Machine 染缸盘头</p>	 <p>QLQ-TZIM Automatic Tape & Zipper Ironing Machine (two lines) 全自动布带和拉链烫平机(双进双出)</p>	 <p>QLQ-NIIM-1 Automatic Nylon & Invisible Zipper Ironing Machine (one chamber) 全自动尼龙和隐形拉链烫平机(单箱)</p>
 <p>QLQ-NIIM-2 Automatic Nylon & Invisible Zipper Ironing Machine (new type, two chambers) 全自动尼龙和隐形拉链烫平机(新款,两箱)</p>	 <p>QLQ-SFM Tape/Zipper Shape Fixing Machine (after dyeing, there are 3 models for choosing) 此机有三款可供选择 1-全自动布带染色后定型机(滚筒式) 2-尼龙拉链染色后定型机 3-布带&尼龙拉链染色后定型机</p>	 <p>QLQ-LCWM Automatic Long-chain Zipper Winding Machine 全自动码装拉链卷码机</p>	 <p>QLQ-LUCM Automatic Long-chain Uncoiling Machine (for zipper & tape) 全自动放码机(拉链和布带可共用)</p>

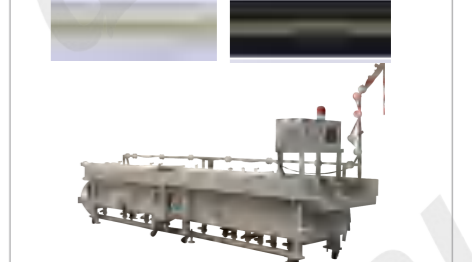

12.4 Plastic Long-chain Zipper Machine

塑钢码装拉链机器

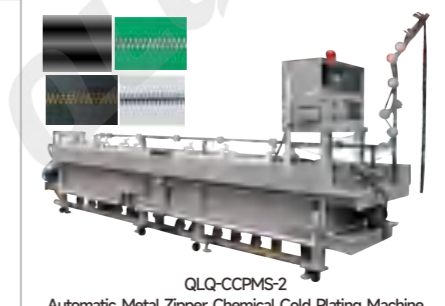
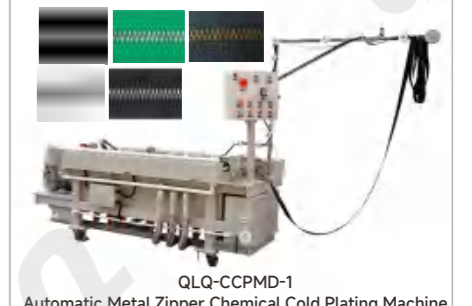
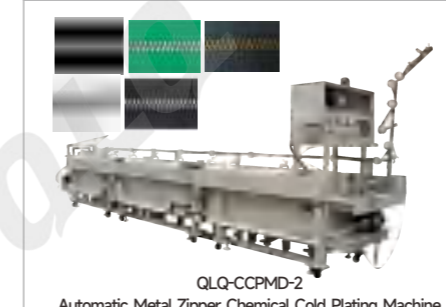
 <p>QLQ-DMM Automatic POM Material Color Mixing Machine (50kg, 100kg, 150kg...) 全自动POM混色机(50kg, 100kg, 150kg...)</p>	 <p>QLQ-DTM Automatic Plastic Zipper Teeth Injection Machine 全自动塑钢拉链排牙注塑机</p>	 <p>QLQ-DCM Automatic Plastic Zipper Waste Crushing Machine 全自动塑钢拉链废料粉碎机</p>	 <p>QLQ-PSFSM-1 Automatic Plastic Zipper Shiny Film Sealing Machine (old model) 全自动塑钢拉链贴膜机(烫金机) 旧款</p>
 <p>QLQ-PSFSM-2 Automatic Plastic Zipper Shiny Film Sealing Machine (new model) 全自动塑钢拉链贴膜机(烫金机) 新款</p>	 <p>QLQ-DMPM Automatic Metallic Plastic Zipper Mirror Face Polishing Machine 全自动仿金属胶牙拉链镜面抛光机</p>	 <p>QLQ-DUVM Automatic Metallic Plastic Zipper UV Lacquer Machine 全自动仿金属胶牙拉链UV机</p>	 <p>QLQ-DMLM Automatic Plastic Zipper Lacquer Machine 全自动塑钢拉链表面叻架机</p>

 <p>QLQ-YTFM Automatic Metal Zipper Y Teeth Wire Manufacturing Machine 全自动金属拉链Y牙拉线机</p>	 <p>QLQ-NTSM Automatic Metal Zipper Normal Teeth Stamping Machine 全自动金属拉链普通牙排牙齿机</p>	 <p>QLQ-RTSM Automatic Metal Zipper Riri Teeth/Corn Teeth Stamping Machine 全自动金属拉链RIRI牙/玉米牙排牙齿机</p>
 <p>QLQ-YTSM-1 Automatic Metal Zipper Y Teeth Stamping Machine (single head) 全自动金属拉链Y牙排牙齿机(单边)</p>	 <p>QLQ-YTSM-2 Automatic Metal Zipper Y Teeth Stamping Machine (double head) 全自动金属拉链Y牙排牙齿机(双边)</p>	 <p>QLQ-YTSM-3 Automatic Metal Zipper Y Teeth Stamping Machine (double heads, 3 in 1 model) 全自动金属拉链Y牙排牙齿机(双头, 3合1一体机)</p>
 <p>QLQ-10THPM Automatic Metal Zipper Teeth-head Intelligent All-around Polishing Machine (single side, 10 pcs wheels) 全自动金属拉链智能侧面全方位牙头抛光机(单边, 10轮)</p>	 <p>QLQ-24THPM Automatic Metal Zipper Teeth-head Intelligent All-around Polishing Machine (double sides, 24 pcs wheels) 全自动金属拉链智能侧面全方位牙头抛光机(双边, 24轮)</p>	 <p>QLQ-C8P Automatic Metal Zipper Chamfering Machine (8 heads) 全自动金属拉链倒角机(8头)</p>
 <p>QLQ-F12P Automatic Metal Zipper Surface Intelligent Polishing Machine (12 pcs wheels) 全自动金属拉链智能平面抛光机(12轮)</p>	 <p>QLQ-FCPM Automatic Metal Zipper Surface Composite Polishing Machine (24 pcs abrasive paper wheels, function: clean the stamping track on the normal zipper) 全自动金属拉链综合型磨光牙抛光机(24轮干叶轮)</p>	 <p>QLQ-F24P Automatic Metal Zipper Surface Intelligent Polishing Machine (24 pcs brass wheels, has better effect for polishing Y teeth & Riri teeth zipper) 全自动金属拉链智能平面精细抛光机(24轮钢丝轮)</p>

 <p>QLQ-FWRPM Adjustment-free Fiber Wheel Refined Polishing Machine 免调节纤维轮精磨抛光机</p>	 <p>QLQ-BPC Brass Powder Collector 吸尘风机</p>	 <p>QLQ-MFPM Automatic Metal Zipper Mirror Face Polishing Machine 全自动金属拉链镜面抛光机</p>
 <p>QLQ-CMBP Automatic Metal Zipper Cleaning Machine (before plating) 全自动金属拉链清洗机(电镀前清洗)</p>	 <p>QLQ-PM Automatic Metal Zipper Plating Machine Note: Above two models are available for your choosing whatever shiny gold plating machine, single chemical tank plating machine or double chemical tanks plating machine. Output: 800-1200M/H, 1500-2000M/H, 2000-2500M/H are available. (Different output modes available)</p>	
 <p>Auto Chemical Feeding System 药水自动添加系统</p>	 <p>Ultrasonic 超声波</p>	 <p>QLQ-GPM-1 Automatic Metal Zipper Shiny Gold Plating Machine (about 800-1200M/H) 全自动金属拉链黄金色电镀机</p>
 <p>QLQ-CCPMS-1 Automatic Metal Zipper Chemical Cold Plating Machine (with one Chemical Tank) (about 800-1200M/H) 全自动金属拉链单色镀层化学冷镀机</p>	 <p>QLQ-CCPMS-2 Automatic Metal Zipper Chemical Cold Plating Machine (with one chemical tank) (1500-2000M/H & 2000-2500M/H are available) 全自动金属拉链单色镀层化学冷镀机</p>	 <p>QLQ-CCPMD-1 Automatic Metal Zipper Chemical Cold Plating Machine (with two chemical tanks) (about 800-1200M/H) 全自动金属拉链双色镀层化学冷镀机</p>
 <p>QLQ-CCPMD-2 Automatic Metal Zipper Chemical Cold Plating Machine (with two chemical tanks) (1500-2000M/H & 2000-2500M/H are available) 全自动金属拉链双色镀层化学冷镀机</p>	 <p>QLQ-EHPM Automatic Metal Zipper Electric Hot Plating Machine (single line, double lines, new model) (about 400M/H) 全自动金属拉链电热电镀机(单带, 新款)</p>	 <p>QLQ-CMAP Automatic Metal Zipper Cleaning & Color Fixing Machine (after plating) 全自动金属拉链固色清洗机(电镀后)</p>

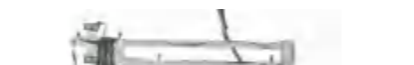
  <p>QLQ-MLM Automatic Metal Zipper Surface Multifunctional Crystal Lacquer Machine (one line, one chamber) 全自动金属拉链表面多功能水晶涂架机(单带,单箱)</p>	  <p>QLQ-MLM2-1 Automatic Metal Zipper Surface Multifunctional Crystal Lacquer Machine (one line, two chambers) 全自动金属拉链表面多功能水晶涂架机(单带,两箱)</p>	  <p>QLQ-MLM2-2 Automatic Metal Zipper Surface Multifunctional Crystal Lacquer Machine (two lines, two chambers) 全自动金属拉链表面多功能水晶涂架机(两带,两箱)</p>
  <p>QLQ-THLM Automatic Metal Zipper Teeth-head Lacquer Machine (single cycle type available & double cycle type for choosing) 全自动金属拉链牙头上涂架机(有单循环和双循环两种款式可选择)</p>	  <p>QLQ-THWM Automatic Metal Zipper Teeth-head Waxing Machine 全自动金属拉链牙头上蜡机</p>	  <p>QLQ-MZPM Automatic Metal Zipper Pressing Machine 全自动金属拉链压平机</p>

12.6 Waterproof Long-chain Zipper Machine

防水码装拉链机器

  <p>QLQ-WZGFSM Automatic Waterproof Zipper Gumming & Film Sealing Machine (2 in 1 model, PVC/TPU/PU available) 全自动二合一防水拉链涂胶贴膜机(原材料:PVC/TPU/PU)</p>	  <p>QLQ-WZGM Automatic Waterproof Zipper Gumming Machine 全自动防水拉链涂胶机</p>	  <p>QLQ-WZFSM Automatic Waterproof Zipper Film Sealing Machine (PVC/TPU/PU are available) 全自动防水拉链贴膜机(原材料:PVC/TPU/PU)</p>
  <p>QLQ-WZSM Automatic Waterproof Zipper Middle Separating Machine 全自动防水拉链分中机</p>	  <p>QLQ-WZEM Automatic Waterproof Zipper Embossing Machine (one line & two lines for choosing) 全自动防水拉链压印机(单带&双带可选)</p>	  <p>QLQ-WZWM Automatic Waterproof Zipper Winding Machine 全自动防水拉链打码机</p>

13 Finished Zipper Manufacturing Machine

条装拉链制造机器

13.1 Nylon Open-end Finished Zipper Machine

尼龙开尾条装拉链机器

 <p>QLQ-NDGM-1 Automatic Nylon Zipper Double Trimming Gapping M/C (long model) 全自动尼龙拉链双选齿定寸机(长款)</p>	 <p>QLQ-NDGM-2 Automatic Nylon Zipper Double Trimming Gapping M/C (short model) 全自动尼龙拉链双选齿定寸机(短款)</p>	 <p>QLQ-UFSM Automatic Nylon Zipper Ultrasonic Film Sealing M/C 全自动尼龙拉链超声波贴胶机</p>	 <p>QLQ-HPM Automatic Nylon Zipper Hole Punching M/C 全自动尼龙拉链冲孔机</p>
 <p>QLQ-UHPM Automatic Nylon Zipper Ultrasonic Hole Punching M/C 全自动尼龙拉链超声波冲孔机</p>	 <p>QLQ-DPBIM-2 Automatic Zipper Open-end Injection M/C (for zipper with/without slider) 全自动拉链开尾注塑机(带拉头和不带拉头的拉链均适用)</p>	 <p>QLQ-DPCM Automatic Zipper Open-end Injection Waste Material Picking & Zipper Combining M/C 全自动拉链去废料合链机(用于开尾拉链)</p>	
 <p>QLQ-DPCM Automatic Zipper Open-end Injection Waste Material Picking & Crushing Machine M/C 全自动拉链去废料粉碎一体机</p>	 <p>QLQ-PBMM Automatic Nylon Zipper Pin Box Fixing M/C 全自动尼龙拉链方块插销固定机</p>	 <p>QLQ-SPMM Semi-automatic Nylon Zipper Pin Fixing M/C 半自动尼龙拉链插销固定机</p>	
 <p>QLQ-SBMM Semi-automatic Nylon Zipper Box Fixing M/C 半自动尼龙拉链方块固定机</p>	 <p>QLQ-PPMM Automatic Nylon Zipper Pin Pin Fixing M/C 全自动尼龙开尾拉链双插销固定机</p>	 <p>QLQ-SPPM Semi-automatic Nylon Zipper Pin Pin Fixing M/C 半自动尼龙拉链双插销固定机</p>	 <p>QLQ-SMM Automatic Nylon Zipper Slider Mounting M/C 全自动尼龙拉链拉头穿头机</p>



QLQ-SMM-1
Automatic Nylon Zipper Double Sides Slider Mounting Machine (side mounting model)
全自动尼龙拉链双边拉头穿头机(侧穿款)

QLQ-TSM
Automatic Nylon Zipper Top Stop M/C (by aluminum top stop wire)
全自动尼龙拉链上止机(铝上止线)

QLQ-STSM-1
Semi-automatic Nylon Zipper Top Stop M/C (by aluminum top stop wire)
半自动尼龙拉链上止机(铝上止线)

QLQ-NUTM
Automatic Nylon Zipper Ultrasonic "U" Shape Top Stop M/C (by transparent top stop wire, with one welding head)
全自动尼龙拉链"U"型上止机(透明上止线, 带一个焊头)



QLQ-SNUTM
Semi-automatic Nylon Zipper Ultrasonic "U" Shape Top Stop M/C (by transparent top stop wire)
半自动尼龙拉链超声波"U"型上止机(透明上止线)

QLQ-SMM
Automatic Nylon Zipper Single Side Slider Mounting M/C (normal mounting model)
全自动尼龙拉链单边拉头穿头机(普通款)

QLQ-SMM-4
Automatic Nylon Zipper Single Side Slider Mounting M/C (side mounting model)
全自动尼龙拉链单边拉头穿头机(侧穿款)



QLQ-OCM-1
Automatic Nylon Zipper Open-end Cutting M/C
全自动尼龙拉链开尾切断机

QLQ-SOCM-1
Semi-automatic Nylon Zipper Open-end Cutting M/C
半自动尼龙拉链开尾切断机

QLQ-OCM-2
Automatic Nylon Zipper Ultrasonic Open-end Cutting M/C
全自动尼龙拉链超声波开尾切断机



QLQ-SOCM-2
Semi-automatic Nylon Zipper Ultrasonic Open-end Cutting M/C
半自动尼龙拉链超声波开尾切断机

QLQ-OCM-3
Automatic Nylon Zipper Open-end Cutting M/C (with labour hand)
全自动尼龙拉链开尾切断机(带机械手)

QLQ-OCM-4
Automatic Nylon Zipper Ultrasonic Open-end Cutting M/C (with labour hand)
全自动尼龙拉链超声波开尾切断机(带机械手)

13.2 Nylon Closed-end Finished Zipper Machine

尼龙闭尾条装拉链机器



QLQ-NDGM-1
Automatic Nylon Zipper Double Trimming Gapping M/C (long model)
全自动尼龙拉链双选齿定寸机(长款)

QLQ-NDGM-2
Automatic Nylon Zipper Double Trimming Gapping M/C (short model)
全自动尼龙拉链双选齿定寸机(短款)

QLQ-NDGBM
Automatic Nylon Zipper Double Trimming Gapping & Bottom Stop M/C (by aluminum bottom stop wire)
全自动尼龙拉链双选齿定寸连下止机(铝下止线)



QLQ-BSM
Automatic Nylon Zipper Bottom Stop M/C (by aluminum bottom stop wire)
全自动尼龙拉链下止机(铝下止线)

QLQ-UBSM
Automatic Nylon Zipper Ultrasonic Bottom Stop M/C (by transparent bottom stop wire)
全自动尼龙拉链超声波卡尺线下止机(透明下止线)

QLQ-UMBSM
Automatic Nylon Zipper Ultrasonic Teeth Melting Bottom Stop M/C (melt teeth directly, without wire)
全自动尼龙拉链超声波熔齿下止机(不用线材, 直接熔齿)



QLQ-SMM
Automatic Nylon Zipper Slider Mounting M/C
全自动尼龙拉链拉头穿头机

QLQ-TSM
Automatic Nylon Zipper Top Stop M/C
(by aluminum top stop wire)
全自动尼龙拉链止机(铝上止线)

QLQ-STSM-1
Semi-automatic Nylon Zipper Top Stop M/C
(by aluminum top stop wire)
半自动尼龙拉链止机(铝上止线)



QLQ-NUMM
Automatic Nylon Zipper Ultrasonic 4-points
Teeth Melting M/C
全自动尼龙拉链超声波4点熔齿机

QLQ-NUTM
Automatic Nylon Zipper Ultrasonic "U" Shape
Top Stop M/C (by transparent top stop wire,
with one welding head)
全自动尼龙拉链"U"型上止机(透明上止线, 带一个焊头)

QLQ-SNUTM
Semi-automatic Nylon Zipper Ultrasonic "U"
Shape Top Stop M/C (by transparent top stop wire)
半自动尼龙拉链超声波"U"型上止机(透明上止线)

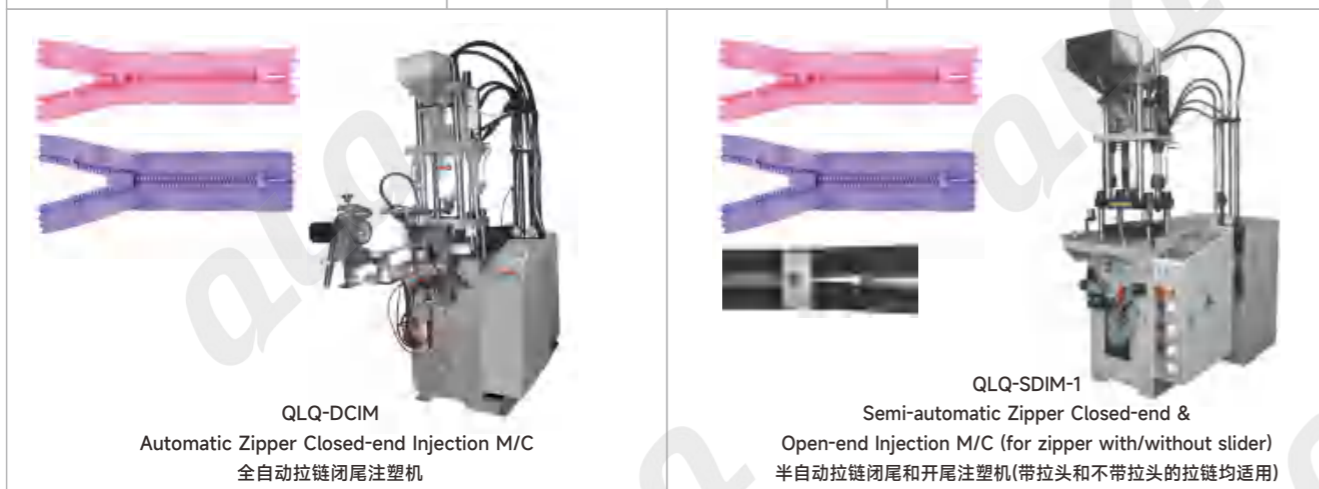

QLQ-DCIM
Automatic Zipper Closed-end Injection M/C
全自动拉链闭尾注塑机

QLQ-SDIM-1
Semi-automatic Zipper Closed-end &
Open-end Injection M/C (for zipper with/without slider)
半自动拉链闭尾和开尾注塑机(带拉头和带不带拉头的拉链均适用)

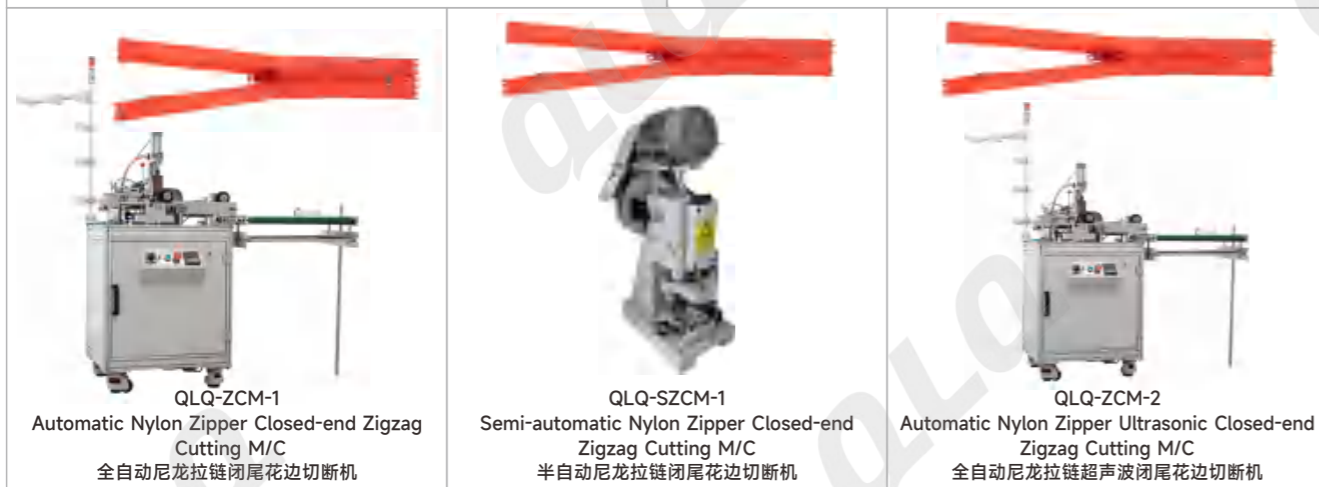

QLQ-ZCM-1
Automatic Nylon Zipper Closed-end Zigzag
Cutting M/C
全自动尼龙拉链闭尾花边切断机

QLQ-SZCM-1
Semi-automatic Nylon Zipper Closed-end
Zigzag Cutting M/C
半自动尼龙拉链闭尾花边切断机

QLQ-ZCM-2
Automatic Nylon Zipper Ultrasonic Closed-end
Zigzag Cutting M/C
全自动尼龙拉链超声波闭尾花边切断机



QLQ-ZCM-3
Automatic Nylon Zipper Closed-end Zigzag Cutting M/C
(with labour hand)
全自动尼龙拉链闭尾花边切断机(带机械手)

QLQ-ZCM-4
Automatic Nylon Zipper Ultrasonic Closed-end Zigzag Cutting M/C
(with labour hand)
全自动尼龙拉链超声波闭尾花边切断机(带机械手)

13.3 Invisible Finished Zipper Machine

隐形条装拉链机器



QLQ-IGM
Automatic Invisible Zipper Double Trimming
Gapping M/C (long model)
全自动隐形拉链双选齿定寸机(长款)

QLQ-IUBSM
Automatic Invisible Zipper Ultrasonic Teeth
Melting Bottom Stop M/C (melt teeth directly,
without wire)
全自动隐形拉链超声波熔齿下止机(不用线材, 直接熔齿)

QLQ-IDGUBM
Automatic Invisible Zipper Double Trimming
Gapping & Ultrasonic Teeth
Melting Bottom Stop M/C
全自动隐形拉链双选齿定寸连超声波熔齿下止机



QLQ-ISMM
Automatic Invisible Zipper Slider Mounting
M/C
全自动隐形拉链拉头穿头机

QLQ-IUIM
Automatic Invisible Zipper Ultrasonic "I" Shape
Top Stop M/C (by transparent round top stop
wire)
全自动隐形拉链超声波"I"型上止机(透明圆上止线)

QLQ-IUUM
Automatic Invisible Zipper Ultrasonic "U"
Shape Top Stop M/C (by transparent top
stop wire, with one welding head)
全自动隐形拉链超声波"U"型上止机
(透明上止线, 带1个焊头)







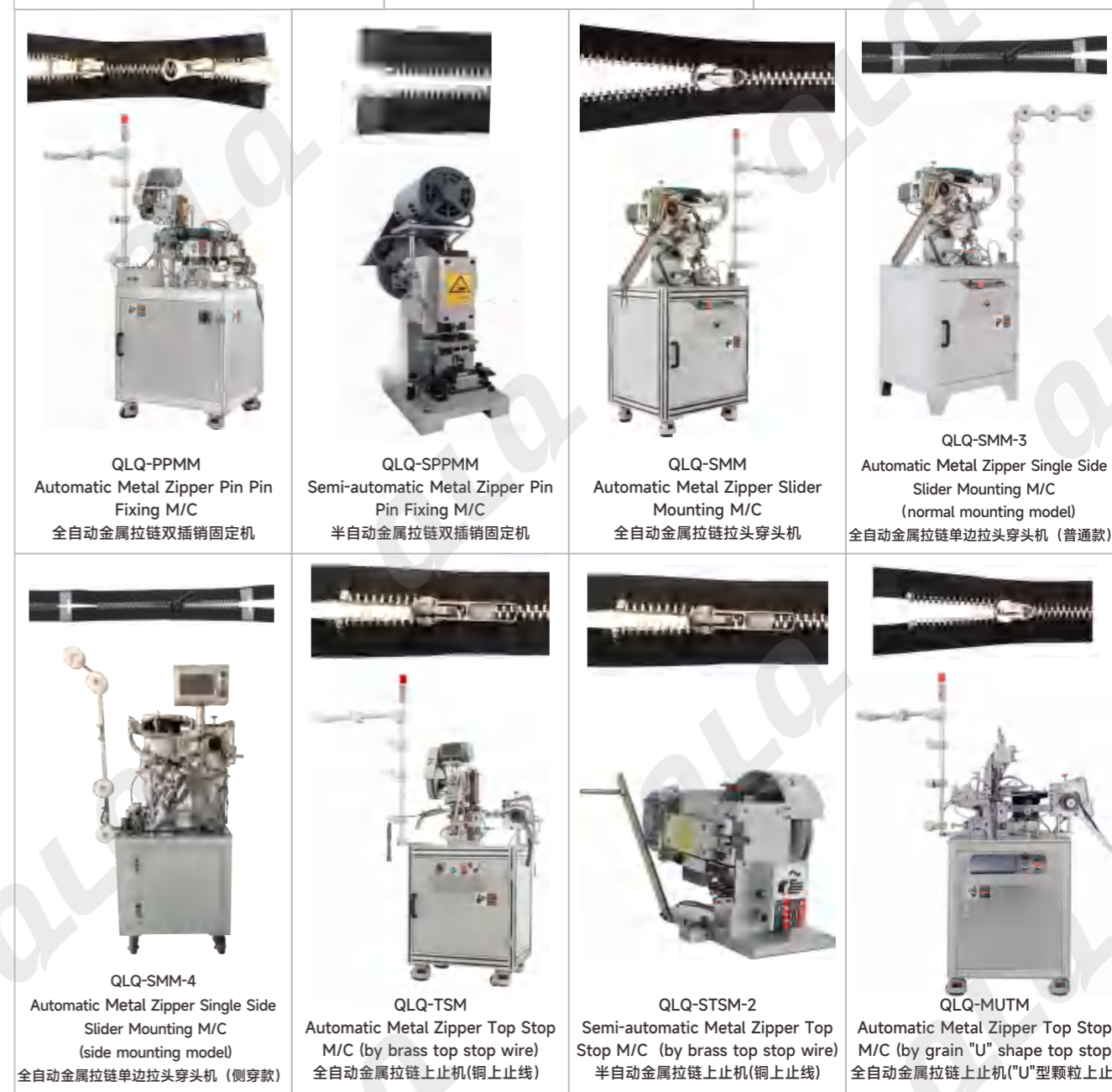



13.4 Metal Open-end Finished Zipper Machine













金属开尾条装拉链机器























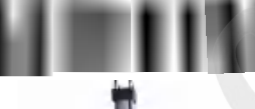



13.5 Metal Closed-end Finished Zipper Machine

 <p>QLQ-SMUTM Semi-automatic Metal Zipper Top Stop M/C (by grain "U" shape top stop) 半自动金属拉链上止机("U"型颗粒上止)</p>	 <p>QLQ-METM Automatic Metal Zipper Top Stop M/C (by grain European shape top stop) 全自动金属拉链上止机(欧款颗粒上止)</p>	 <p>QLQ-SMETM Semi-automatic Metal Zipper Top Stop M/C (by grain European shape top stop) 半自动金属拉链上止机(欧款颗粒上止)</p>
 <p>QLQ-OCM-1 Automatic Metal Zipper Open-end Cutting M/C 全自动金属拉链开尾切断机</p>	 <p>QLQ-SOCM-1 Semi-automatic Metal Zipper Open-end Cutting M/C 半自动金属拉链开尾切断机</p>	 <p>QLQ-OCM-2 Automatic Metal Zipper Ultrasonic Open-end Cutting M/C 全自动金属拉链超声波开尾切断机</p>
 <p>QLQ-SOCM-2 Semi-automatic Metal Zipper Ultrasonic Open-end Cutting M/C 半自动金属拉链超声波开尾切断机</p>	 <p>QLQ-OCM-3 Automatic Metal Zipper Open-end Cutting M/C(with labour hand) 全自动金属拉链开尾切断机(带机械手)</p>	 <p>QLQ-OCM-4 Automatic Metal Zipper Ultrasonic Open-end Cutting M/C (with labour hand) 全自动金属拉链超声波开尾切断机(带机械手)</p>

 <p>QLQ-MGM Automatic Metal Zipper Gapping M/C (long model) 全自动金属拉链普通定寸机(长款)</p>	 <p>QLQ-MDGM-1 Automatic Metal Zipper Double Trimming Gapping M/C (long model) 全自动金属拉链双选齿定寸机(长款)</p>	 <p>QLQ-MDGM-2 Automatic Metal Zipper Double Trimming Gapping M/C (short model) 全自动金属拉链双选齿定寸机(短款)</p>
 <p>QLQ-BSM Automatic Metal Zipper Bottom Stop M/C (by brass bottom stop wire) 全自动金属拉链下止机(铜下止线)</p>	 <p>QLQ-HBSM Automatic Metal Zipper "H" Bottom Stop M/C (have 1 piece model and multiple pieces model for choosing) 全自动金属拉链工字码下止机(有单粒款和多粒款)</p>	 <p>QLQ-SHBSM Semi-automatic Metal Zipper "H" Bottom Stop Fixing M/C 半自动金属拉链工字码下止固定机</p>
 <p>QLQ-SMM Automatic Metal Zipper Slider Mounting M/C 全自动金属拉链拉头穿头机</p>	 <p>QLQ-TSM Automatic Metal Zipper Top Stop M/C (by brass top stop wire) 全自动金属拉链上止机(铜上止线)</p>	 <p>QLQ-STSM-2 Semi-automatic Metal Zipper Top Stop M/C (by brass top stop wire) 半自动金属拉链上止机(铜上止线)</p>

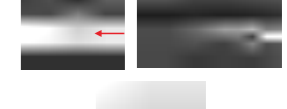
  <p>QLQ-MUTM Automatic Metal Zipper Top Stop M/C (by grain "U" shape top stop) 全自动金属拉链上止机("U"型颗粒上止)</p>	  <p>QLQ-SMUTM Semi-automatic Metal Zipper Top Stop M/C (by grain "U" shape top stop) 半自动金属拉链上止机("U"型颗粒上止)</p>	  <p>QLQ-METM Automatic Metal Zipper Top Stop M/C (by grain European shape top stop) 全自动金属拉链上止机(欧款颗粒上止)</p>
  <p>QLQ-SMETM Semi-automatic Metal Zipper Top Stop M/C (by grain European shape top stop) 半自动金属拉链上止机(欧款颗粒上止)</p>	  <p>QLQ-ZCM-1 Automatic Metal Zipper Closed-end Zigzag Cutting M/C 全自动金属拉链闭尾花边切断机</p>	  <p>QLQ-SZCM-1 Semi-automatic Metal Zipper Closed-end Zigzag Cutting M/C 半自动金属拉链闭尾花边切断机</p>
  <p>QLQ-ZCM-2 Automatic Metal Zipper Ultrasonic Closed-end Zigzag Cutting M/C 全自动金属拉链超声波闭尾花边切断机</p>	  <p>QLQ-ZCM-3 Automatic Metal Zipper Closed-end Zigzag Cutting M/C (with labour hand) 全自动金属拉链闭尾花边切断机(带机械手)</p>	  <p>QLQ-ZCM-4 Automatic Metal Zipper Ultrasonic Closed-end Zigzag Cutting M/C (with labour hand) 全自动金属拉链超声波闭尾花边切断机(带机械手)</p>

  <p>QLQ-DGM Automatic Plastic Zipper Gapping M/C 全自动塑钢拉链普通定寸机</p>	  <p>QLQ-UFSM Automatic Plastic Zipper Ultrasonic Film Sealing M/C 全自动塑钢拉链超声波贴胶机</p>	  <p>QLQ-HPM Automatic Plastic Zipper Hole Punching M/C 全自动塑钢拉链冲孔机</p>	  <p>QLQ-DOIM-1 Automatic Plastic Zipper Open-end Injection M/C (only for zipper without slider) 全自动塑钢拉链开尾注塑机 (只适用不带拉头的拉链)</p>
  <p>QLQ-DOIM-2 Automatic Plastic Zipper Open-end Injection M/C (for zipper with/without slider) 全自动塑钢拉链开尾注塑机 (带拉头和不带拉头的拉链均适用)</p>	  <p>QLQ-SDIM-1 Semi-automatic Plastic Zipper Closed-end & Open-end Injection M/C (for zipper with/without slider) 半自动塑钢拉链闭尾和开尾注塑机 (带拉头和不带拉头的拉链均适用)</p>	  <p>QLQ-SDIM-2 Semi-automatic Plastic Zipper Injection M/C (open-door model, only inject top stop/bottom stop/pin box/pin pin) 半自动塑钢拉链注塑机 (开门式,只注塑上止/下止/方块插销/双插销)</p>	  <p>QLQ-SMM-3 Automatic Plastic Zipper Single Side Slider Mounting M/C (normal mounting model) 全自动塑钢拉链单边拉头穿头机 (普通款)</p>
  <p>QLQ-SMM-4 Automatic Plastic Zipper Single Side Slider Mounting M/C (side mounting model) 全自动塑钢拉链单边拉头穿头机 (侧穿款)</p>	  <p>QLQ-DPSMCM Automatic Plastic Zipper Injection Waste Material Picking, Slider Mounting & Zipper Combining Machine (for open-end zipper) 全自动塑钢拉链去废料穿头合链机 (用于开尾拉链)</p>	  <p>QLQ-DPCM Automatic Plastic Zipper Injection Waste Material Picking & Zipper Combining M/C 全自动塑钢拉链去废料合链机 (用于开尾拉链)</p>	  <p>QLQ-DPCM Automatic Zipper Open-end Injection Waste Material Picking & Crushing Machine M/C 全自动拉链去废料粉碎一体机</p>

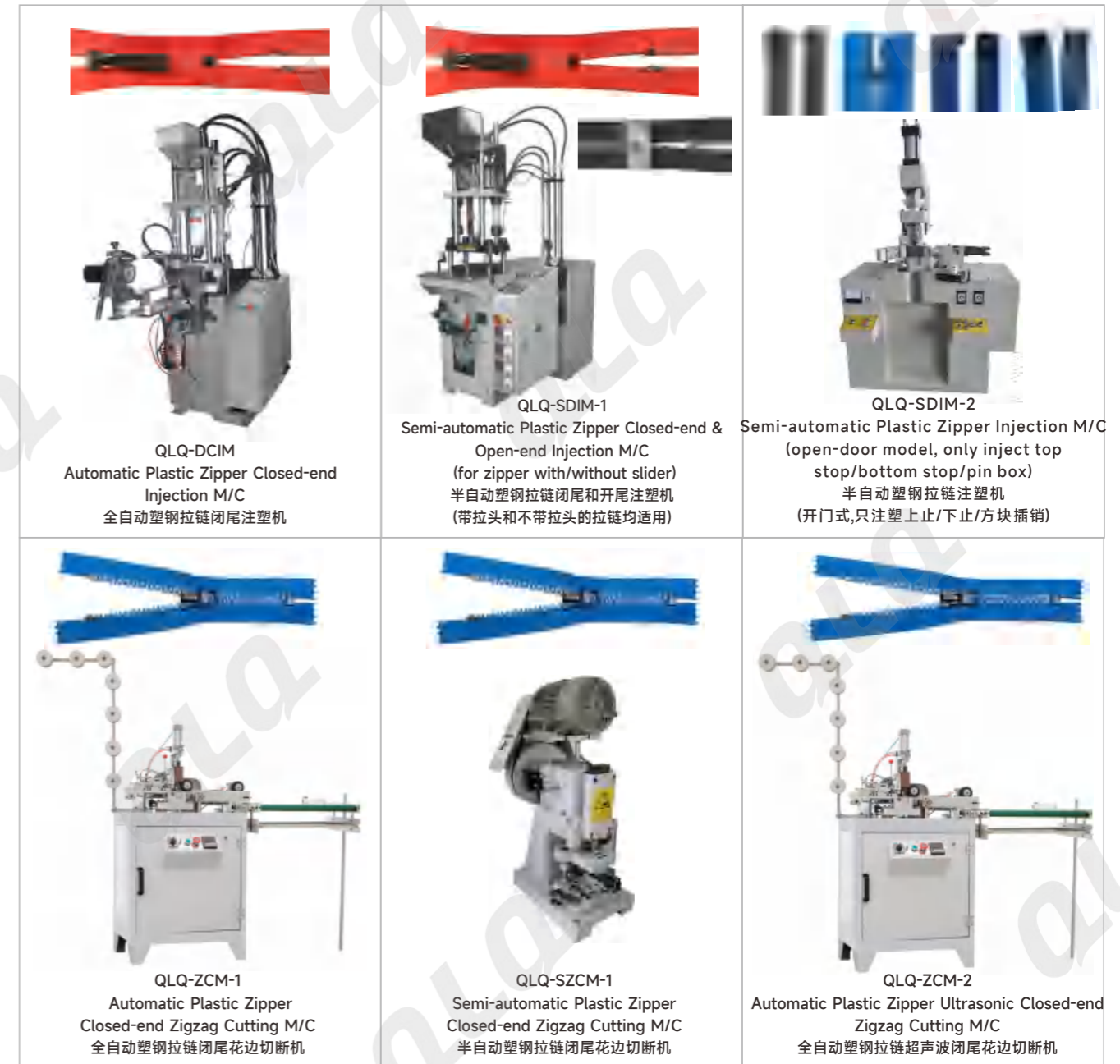

13.7 Plastic Closed-end Finished Zipper Machine

塑钢闭尾条装拉链机器



13.8 Special Finished Zipper Machine

特殊条装拉链机器

 <p>QLQ-UCTMM Automatic Nylon Zipper Ultrasonic Edge Curling & Teeth Melting M/C 全自动尼龙拉链超声波卷边熔齿机</p>	 <p>QLQ-SMM-5 Automatic Nylon Zipper Slider Mounting M/C (used for zipper with 2 sides of bottom stop) 全自动尼龙拉链拉头穿头机(用于双边带下止的拉链)</p>	 <p>QLQ-DSMM Automatic Zipper Double Sliders Mounting Machine 全自动拉链双拉头穿头机</p>
 <p>QLQ-BSM-1 Automatic Nylon Zipper Special Bottom Stop M/C (by aluminum bottom stop wire, with 2 sides of bottom stop) 全自动尼龙拉链特殊下止机(铝下止线,双边下止)</p>	 <p>QLQ-SMCM Automatic Zipper Slider Mounting & Cutting Machine 全自动拉链切断穿头机</p>	 <p>QLQ-DSMCM Automatic Zipper Double Sliders Mounting & Cutting Machine 全自动拉链双拉头切断穿头机</p>
 <p>QLQ-SCBM Automatic Plastic Zipper Slider Mounting & Ultrasonic Cutting & Box Fixing M/C (3 in 1) 全自动塑料拉链拉头穿头、超声波切断和方块固定一体机</p>	 <p>QLQ-CBM Automatic Plastic Zipper Ultrasonic Cutting & Box Fixing M/C (2 in 1) 全自动塑料拉链超声波切断和方块固定一体机</p>	 <p>QLQ-ZPM Zipper Packing Machine 拉链包装机</p>

13.9 PVC Without Teeth Zipper Manufacturing Machine

PVC无齿拉链制造机



QLQ-PZMM
PVC Without Teeth Zipper Manufacturing Machine
PVC无齿拉链制造机



PVC Grain
PVC颗粒



PVC Color Master Batch
PVC色母



14 Spare Part of Zipper Manufacturing Machine

拉链机器零件

14.1 Spare Part of Automatic Centre Cord Machine

全自动中心线机零件

 <p>Stainless Steel Pipe 不锈钢管</p>	 <p>Multihole Belt 多孔皮带</p>	 <p>Latitude Needle & Latitude Needle Seat 纬针和纬针座</p>	 <p>Hooked Needle Seat 勾针座</p>	 <p>Balance Wheel 摆轮</p>
--	--	--	---	---

14.2 Spare Part of Automatic Needle Loom Machine

全自动织带机零件

 <p>Aluminum Handle 铝手</p>	 <p>Pole of Needle Block 挡针杆</p>	 <p>Yarn Needle 棕丝片</p>	 <p>Spring of Weft Yarn 纬纱弹簧</p>	 <p>Pressing Wheel 压轮</p>
---	---	--	---	--

14.3 Spare Part of Automatic Coil Forming Machine

全自动成型机零件

 <p>6001 Stabilizing Shaft 稳定心轴</p>	 <p>Forming Screw 成型螺杆</p>	 <p>Umbrella Teeth Wheel 伞齿轮</p>	 <p>Hitting Head 打头</p>	 <p>Black Head 黑头</p>
--	---	---	--	--

14.4 Spare Part of Automatic Sewing Machine

全自动缝合机零件

 <p>Thread Pressing Plate 压线板</p>	 <p>Spring Slice 弹片</p>	 <p>Sewing Needle 缝针</p>	 <p>Hooked Needle Seat 缝合机勾针座</p>	 <p>Top Seat of Cover Plate 盖板上座</p>
 <p>Sliding Plate for Adjusting Needle Space (rear) 针距调整滑板后</p>	 <p>Steel Bead 钢珠</p>	 <p>Observed Sleeve for Adjusting Zipper Size 拉链尺寸调整视套</p>	 <p>Roller Turning Wheel 罗拉转盘</p>	 <p>Cover of Roller Turning Wheel 罗拉转盘盖子</p>

14.5 Spare Part of Automatic Normal Teeth Stamping Machine 全自动金属拉链普通牙排牙植齿机零件

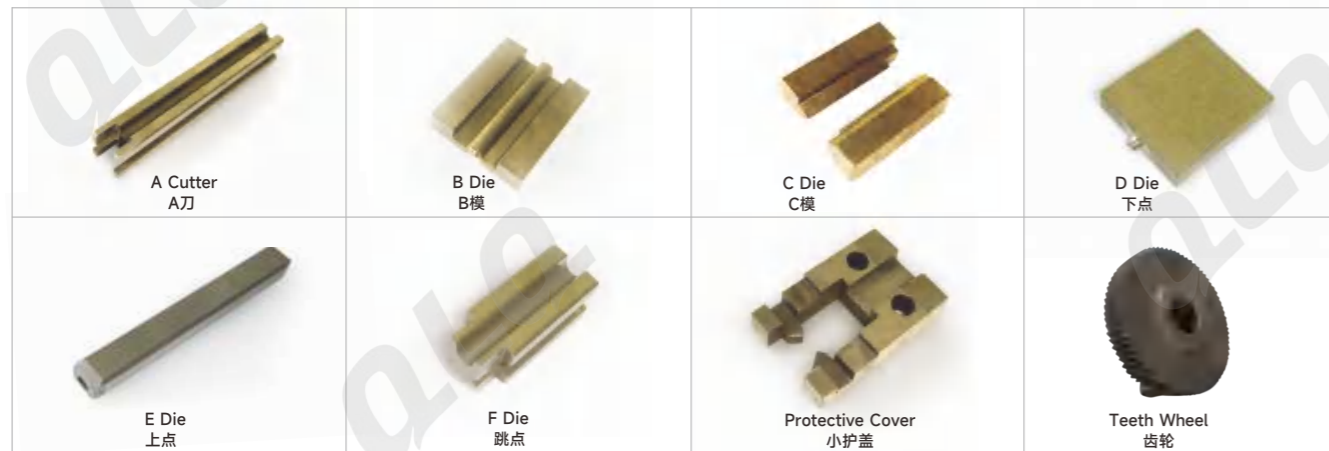

14.6 Spare Part of Automatic Y Teeth Stamping Machine 全自动金属拉链Y牙排牙植齿机零件



14.7 Spare Part of Automatic European Teeth Stamping Machine 全自动金属拉链欧款牙排牙植齿机零件

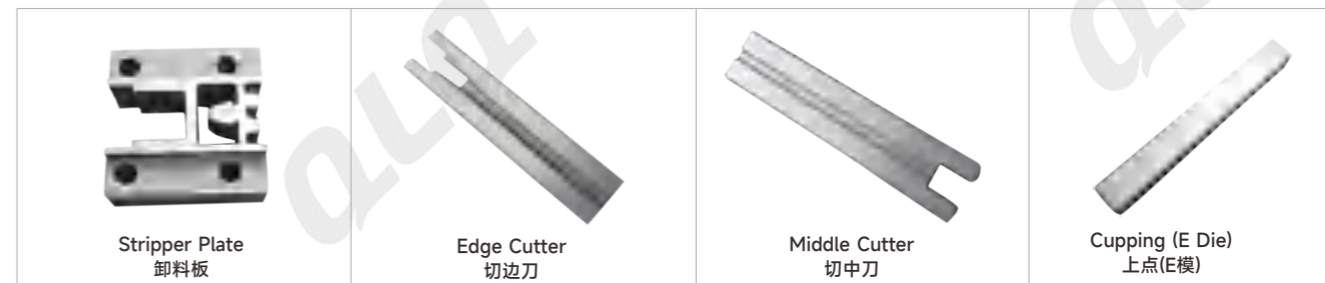

14.8 Spare Part of Some Finished Zipper Machine 部分条装拉链机器零件



15 Silicone Product Manufacturing Machine

硅胶产品制造机器

 QLQ-SGM Silicone Gum Machine 硅胶炼胶机	 QLQ-SCM Silicone Cutting Machine 硅胶切料机	 QLQ-LSMM Liquid Silicone Mixing Machine 水滴胶搅拌机
 QLQ-LSVM Liquid Silicone Vacuum Machine 水滴胶真空机	 QLQ-12LSDM 12-color Liquid Silicone Dispensing Machine 12色水滴胶机扣	 QLQ-SOM Silicone Oven Machine 烤模台
 QLQ-50SHM 50T Single-head Hydraulic Machine 50吨单头油压机	 QLQ-50DHM 50T Double-head Hydraulic Machine 50吨双头油压机	

16 PVC Product Manufacturing Machine

PVC产品制造机器

 QLQ-PMM PVC Mixing Machine PVC搅拌机	 QLQ-PVDM PVC Vacuum Defoaming Machine PVC真空脱泡机组	 QLQ-PDM PVC Dispensing Machine PVC滴胶机
 QLQ-POM PVC Oven Machine PVC烤箱	 QLQ-PHCM PVC Heat Sealing Machine PVC热合模机	













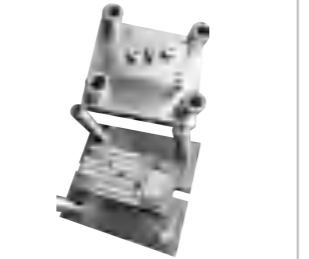
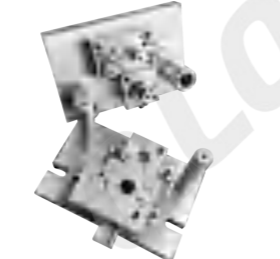

17 Mould Related Machine & Tool

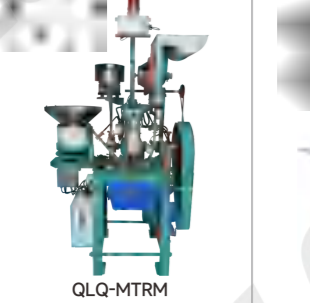
制作各种模具的相关机器及工具

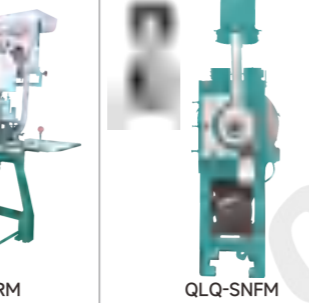
 QLQ-HSM Horizontal Type Sawing Machine 卧式锯床	 QLQ-SGM Automatic Surface Grinding Machine 自动平面磨床	 QLQ-PMSGM Precision Manual Surface Grinding Machine 精密手动平面磨床	 Grinding Wheel 磨床用的砂轮
 QLQ-EMM Express Milling Machine 快捷铣床	 QLQ-SDM Small Drilling Machine 小钻床	 QLQ-TM Tapping Machine (Table model) 台式攻牙机	 QLQ-HSL Horizontal Semi-automatic Lathe 卧式半自动车床
 QLQ-HWCM High Speed Wire Cutting Machine 快走丝线切割机床	 QLQ-MWCM Medium Speed Wire Cutting Machine 中走丝线切割机床	 QLQ-LWCM Low Speed Wire Cutting Machine 慢走丝线切割机床	 QLQ-CEMM CNC Engraving & Milling Machine 北京精雕机
 QLQ-KGM Knife Grinding Machine 磨刀机	 QLQ-2DEM 2D Engraving Machine 平面雕刻机	 QLQ-3DEM 3D Engraving Machine 立体雕刻机	 QLQ-GM Grinding Machine 砂轮机
 QLQ-EDM Electric Discharge Machine 电火花机DF435	 QLQ-MSM Mirror Spark Machine 镜面火花机	 QLQ-PT Projector 投影仪	 QLQ-SMCM Side Milling and Chamfering Machine-Table Model 台式侧铣倒角机
 QLQ-RHT Rockwell Hardness Tester 洛氏硬度计	 QLQ-LM Laser Machine 激光机	 Oilstone 油石	 Oil Gypsum 油石膏



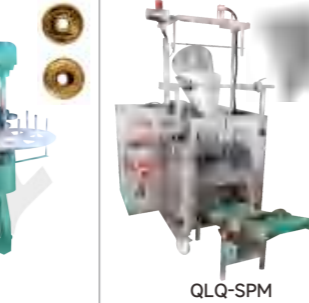
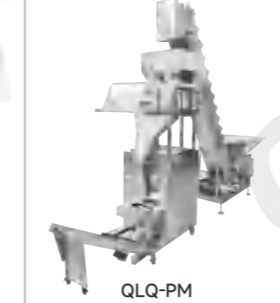







18.1 Button Machine

钮扣设备

 QLQ-APM 18T/25T Automatic Pressing Machine 18T/25T冲床	 QLQ-SPM 18T/25T Stretching Pressing Machine 18T/25T拉伸冲床	 Compound Mould (flexible logo) 复合模 (可换logo字粒)	 Push Mould (flexible logo) 推尺模 (可换logo字粒)
 QLQ-PCRM Plastic Core Riveting Machine 胶芯入壳双转铆合机 (RTT型)	 QLQ-TRM Two in One Riveting Machine 二合一铆合机 (RST型)	 QLQ-MTRM Two in One Riveting Machine (Monitor model) 二合一铆合机 (RST-V监控型)	 QLQ-TRM Three in One Riveting Machine 三合一铆合机 (RSTS型)
 QLQ-MTRM Three in One Riveting Machine (Monitor model) 三合一铆合机 (RSTS-V监控型)	 QLQ-SZARM Semi-automatic Zinc Alloy Riveting Machine 轻型半自动锌合金铆合机	 QLQ-AZARM Automatic Zinc Alloy Riveting Machine 全自动锌合金铆合机	 QLQ-SNFM Single-head Neck Forming Machine 单头颈颈机
 QLQ-DNFM Double-head Neck Forming Machine 双头颈颈机	 QLQ-BRM Bead Riveting Machine ED型云珠铆合机	 QLQ-PSBSVM Prong Snap Button Single Vibrating Machine 五爪子单振机	 QLQ-WM Wiring Machine 打线机 (PLR-II)
 QLQ-SPM Semi-automatic Button/ Slider Packing Machine 半自动纽扣/拉头打包机	 QLQ-PM Automatic Button/ Slider Packing Machine 全自动纽扣/拉头打包机		

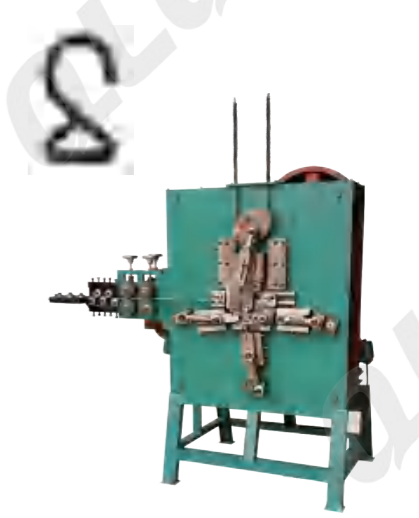
卷材尺寸/Roll material sizes: 0.2*14mm, 0.2*19mm, 0.2*22mm, 0.2*25mm, 0.23*14mm, 0.23*26mm

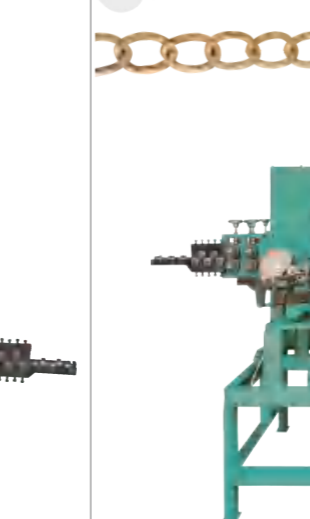
 Button Stainless Steel Strip Roll 钮扣不锈钢卷带	 Brass Strip Roll 铜卷带	 Aluminum Strip Roll 铝卷带	 Zinc Alloy Strip Roll 锌合金卷带	 Galvanized Iron Strip Roll 镀锌铁卷带
---	--	---	--	--

 QLQ-ADHAM Automatic Dog Hook Assembly Machine 狗扣自动组装机	 QLQ-HPM Hand Punching Machine 手动冲压机	 QLQ-DHTFM Dog Hook Tail Fixing Machine 狗扣打尾组装机	 QLQ-MPBFM Metal Plastic Button Fixing Machine 金属塑料钉扣机
 QLQ-ARMM Automatic Ring Making Machine 全自动线材打圈机	 QLQ-MEBMM Multi-axis Electric Buckle Making Machine 多轴电动打扣机	 QLQ-AWBMM Automatic Wire Buckle Making Machine 自动线材打扣机	
 QLQ-AWRBMM Automatic Wire Roller Buckle Making Machine 全自动线材拉芯扣机	 QLQ-ECMM Electric Chain Making Machine 电动打链机	 QLQ-CPM Chain Polishing Machine 磨链机	

 <p>QLQ-ETTM Automatic Electronic Type Tension Test Machine 全自动电子式多功能拉力测试机</p>	 <p>QLQ-RFTM Automatic Zipper Reciprocating Fatigue Test Machine 全自动拉链疲劳测试机</p>	 <p>QLQ-STTM Automatic Slider Torsion Test Machine 全自动拉头扭力测试机</p>	 <p>QLQ-SSTM Automatic Saline Spray Test Machine 全自动盐水喷雾测试机</p>
 <p>QLQ-NDM-1 Automatic Conveyor Belt Needle Detecting Machine (made in China) 全自动输送带检针机 (国产)</p>	 <p>QLQ-NDM-2 Automatic Conveyor Belt Needle Detecting Machine (Hashima, imported) 全自动输送带检针机 (进口)</p>	 <p>QLQ-LSB Automatic Standard Light Source Box 全自动标准光源箱</p>	 <p>QLQ-HPC Automatic High Precision Colorimeter 全自动高精度色差仪</p>
 <p>QLQ-MDTM Manual Decoloration Test Machine 手动脱色测试机</p>	 <p>QLQ-DCTM Automatic Electronic Type Decolorization Test Machine 全自动电动脱色测试机</p>	 <p>QLQ-DWTM Automatic Dye Washing Fastness Test Machine 全自动染色耐水洗测试机</p>	 <p>QLQ-ASTM Automatic Shrinkage Test Machine 全自动缩水率测试机</p>

     <p>QLQ-CJM-1 Computerized Jacquard Machine (made in China) 电脑提花机 (国产)</p>
     <p>QLQ-CJM-2 Computerized Jacquard Machine (made in Taiwan) 电脑提花机 (进口)</p>
    <p>QLQ-CM Crochet Machine 钩编机</p>

22 Hook & Loop/Velcro Manufacturing Machine

粘扣带制造机器

		
QLQ-VWPM Velcro Warping Machine 粘扣带整经机	QLQ-VWVM Velcro Weaving Machine 粘扣带织带机	QLQ-VDM Velcro Dyeing Machine 粘扣带染缸
		
QLQ-VRM Velcro Raising Machine (loop) 粘扣带起毛机 (毛面)	QLQ-VGSM Velcro Gluing & Setting Machine (hook) 粘扣带上胶定型机 (钩面)	
		
QLQ-VGM Velcro Gluing Machine 背胶机	QLQ-VMHMM Velcro Mushroom Head Molding Machine 烧蘑菇头机	QLQ-VHCM Velcro Hook Cutting Machine 粘扣带切钩机
		
QLQ-VSM Velcro Slitting Machine 粘扣带分条机	QLQ-VRM Velcro Rolling Machine 粘扣带卷带机	QLQ-VSRM Velcro Slitting & Rolling Machine 裁条卷带机

23 Centrifugal Die Casting Series Manufacturing Machine & Raw Material

离心压铸系列机器

		
QLQ-SMPM Semi-automatic Mould Pressing Machine 半自动压模机	QLQ-AMPM Automatic Mould Pressing Machine 全自动压模机	QLQ-EMF Electric Melting Furnace 普通电熔炉
		
QLQ-INCMF Intelligent NC Melting Furnace 智能数控熔炉	QLQ-SCM Semi-automatic Centrifugal Machine 半自动离心机	QLQ-ACM Automatic Centrifugal Machine 全自动离心机
		
		
		
		

24 Raw Material & Accessory for Zipper & Slider

拉链和拉头的原材料及配件

24.1 Yarn (150D48F, 300D96F,...low elastic yarn & network yarn)

各种规格的纱线(150D48F, 300D96F等规格的弹纱和网络纱)



24.2 Sewing Thread (suitable for sewing zipper tape & monofilament chain)

缝线(用于缝合拉链布带和链齿)



24.3 Centre Cord

各种中心线(单捻, 双捻及编织中心线)



Single Twisted Centre Cord
单捻中心线



Double Twisted Centre Cord
双捻中心线



Weaving Centre Cord
编织中心线

24.4 Monofilament (3#:0.48mm, 0.50mm, 5#:0.68mm, 7#:0.72mm, 0.74mm, 8#:0.78mm, 10#:1.05mm, other sizes are available to be made according to customer's requirement)

单丝



24.5 POM Plastic Grain (M90, M270) & ABS

POM & ABS 塑钢粒

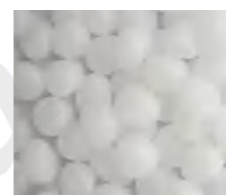

POM



POM



ABS



ABS

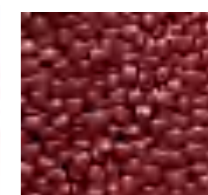

Color Masterbatch
色母



Color Masterbatch
色母

24.6 Transparent Film/Semi-transparent Film (standard size: 15mm/18mm/20mm/22mm*0.13-0.16mm, other sizes are available to be made according to customer's requirement)

透明胶/磨砂胶(半透明胶)



24.7 Fabric Film (standard size: 15mm/18mm/20mm/22mm*0.16-0.18mm, other sizes are available to be made according to customer's requirement)

布胶



24.8 Golden/Silver Film

贴金银膜



24.9 Waterproof Film

防水膜



TPU



PU



PU



PU

24.10 H Bottom Stop (size: 3#, 4#, 5#, 8#, 10#, material: brass, aluminum, zinc, stainless steel)

工字码下止粒 款式:K款和X款(材料:铜,铝,锌,不锈钢)

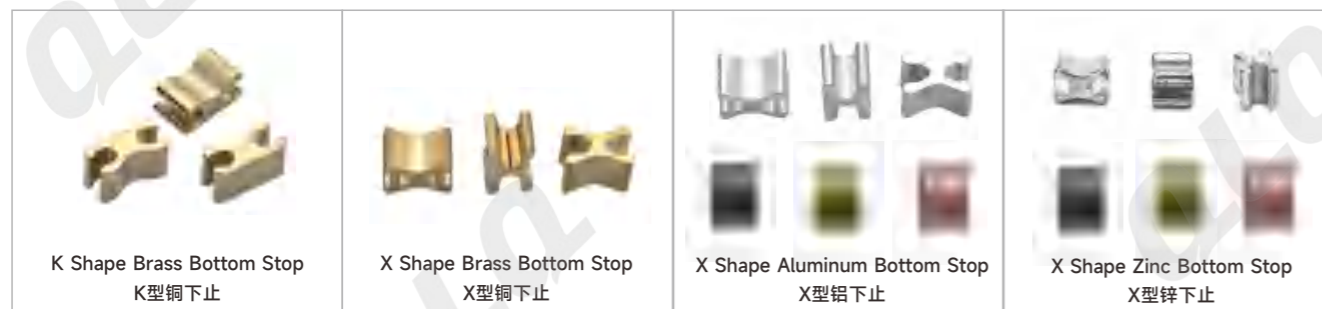

24.11 Claw Bottom Stop (size: 3#, 4#, 5#, 8#, 10#, material: brass, aluminum, iron)

爪下止(材料:铜,铝,铁)



24.12 Grain Top Stop (size: 3#, 4#, 5#, 8#, 10#, material: brass, aluminum, zinc, stainless steel)

颗粒上止(材料:铜,铝,锌,不锈钢)



24.13 Slider Pressing Part

拉头冲压件



25 Wire/Strip for Zipper & Slider

拉链拉头线材

25.1 Flat Wire for Normal Teeth Stamping Machine (material: brass, aluminum, stainless steel, iron)

普通排牙线(材料:铜,铝,不锈钢,铁)

Zipper Size	Normal Size	Small Size
2#	0.6*3.10	
3#	0.75* 3.18	0.75* 3.0
4#	0.90*3.50	0.90*3.18
5#	0.90*3.95	0.90*3.50
7#	1.10*4.40	
8#	1.25 x 4.6	1.10* 4.20
10#	1.45*5.70	

Note: Other sizes are available to be made according to customer's requirement.

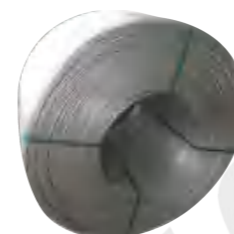

25.2 Y Wire for Y Teeth Stamping Machine (material: brass, aluminum, stainless steel)

Y牙线(材料:铜,铝,不锈钢)



25.3 Bottom Stop Wire (material: brass, aluminum which can be plated to be black nickel, brass, antique brass and other colors)

下止线 材料:铜,铝(胚色和电镀黑镍,黄铜,青古铜等色)

Zipper Size	Bottom Stop Wire Size (mm)
2#	2.4*0.4
3#	3.0*0.4, 3.0*0.35, 3.0*0.45, 3.0*0.5
5#	3.5*0.4, 3.5*0.45, 3.5*0.5, 3.6*0.4, 3.6*0.45, 3.6*0.5, 4.0*0.5, 3.8*0.4
8#	4.5*0.45, 4.5*0.5, 4.8*0.6, 4.8*0.55, 4.2*0.6
10#	6.0*0.6, 5.9*0.5, 5.9*0.55, 4.8*0.6

Note: Other sizes are available to be made according to customer's requirement.



25.4 Top Stop Wire (material: brass, aluminum which can be plated to be black nickel, brass, antique brass and other colors)

上止线 材料:铜,铝(本色和电镀黑镍,黄铜,青古铜等色)

Zipper Size	Brass Top Stop Wire Size (mm)
2#	2.1*0.7
3#	2.2*0.85, 2.2*0.8, 2.2*1.0, 2.2*1.25, 2.1*0.7, 2.0*0.85
4#	2.2*0.85, 2.4*0.9, 2.2*1.0
5#	2.6*1.0, 3.0*0.85, 2.4*0.9, 2.6*0.85, 3.0*0.8, 3.0*1.0, 3.0*0.95, 2.5*1.0, 2.5*1.4, 3.0*1.2, 3.0*0.9
8#	3.1*1.2, 3.8*1.2, 4.0*1.1, 4.0*1.25
10#	4.0*1.25, 4.0*1.4, 4.0*1.1

Note: Other sizes are available to be made according to customer's requirement.

Zipper Size	Aluminum Top Stop Wire Size (mm)
2#	1.78*0.36
3#	1.8*0.4, 1.8*0.35, 1.78*0.36
5#	2.4*0.4, 2.4*0.35, 2.4*0.45, 2.5*0.4
8#	3.5*0.4, 3.6*0.4, 3.6*0.5, 3.0*0.4
10#	3.6*0.4, 3.6*0.5, 3.5*0.4

Note: Other sizes are available to be made according to customer's requirement.



25.5 Transparent Top & Bottom Stop Wire

透明上下止线

Zipper Size	Transparent Top Stop Wire Size (mm)
I3#	1.9*0.5
N3#	1.70*0.65, 1.9*0.75
N5#	2.4*0.95



Zipper Size	Transparent Bottom Stop Wire Size (mm)
used for all sizes of zippers	7.6*0.60

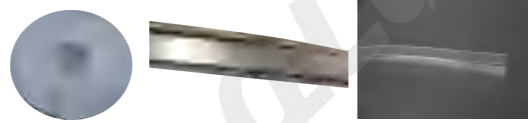

Zipper Size	Transparent Top Stop Round Wire Size (mm)
used for all sizes of zippers	0.90, 1.0, 1.05, 1.2, 1.5



25.6 Other Wire (following sizes are standard sizes, other sizes are available to be made according to customer's requirement)

其它线材

<p>3# Size: 0.11*1.70mm 5# Size: 0.11*2.20mm 8#&10# Size: 0.13*3.15mm</p> <p>Stainless Steel Wire for Cap Spring (this wire is inserted to the cap of 5 components auto-lock slider) 不锈钢帽盖弹片(用于五件套自动拉头)</p>	<p>Size: 0.25*17.50mm 0.25*19.10mm</p> <p>Stainless Steel Wire for 3 Components Auto-lock Slider 不锈钢弹片 (用于制做三件套自动拉头的弹片式帽盖)</p>	<p>Pin Wire for Brass Cap Slider 针线 (用于铜帽盖拉头)</p>
---	--	---

<p>Spring Wire for Brass YG Slider 铜YG头弹弓线</p>	<p>Reference Size: Y Shape Needle: 0.90*19mm C Shape Needle: 0.8*25mm Hook: 0.80*45mm Flat Puller: 0.80*31mm</p> <p>Wire for Some Slider Accessories (Y shape/C shape needle/monkey, hook, flat puller, material: brass, iron.) 扁线 (适用于制做Y型马勾、C型马勾、铁勾、中圈, 材料: 铜、铁)</p>
--	--

26 Slider & Pin Box

各种拉头和方块插销

26.1 Plastic Slider

塑钢拉头



26.2 YG Slider (material: brass, iron, zinc, stainless steel)

YG拉头(材料:铜,铁,锌,不锈钢)

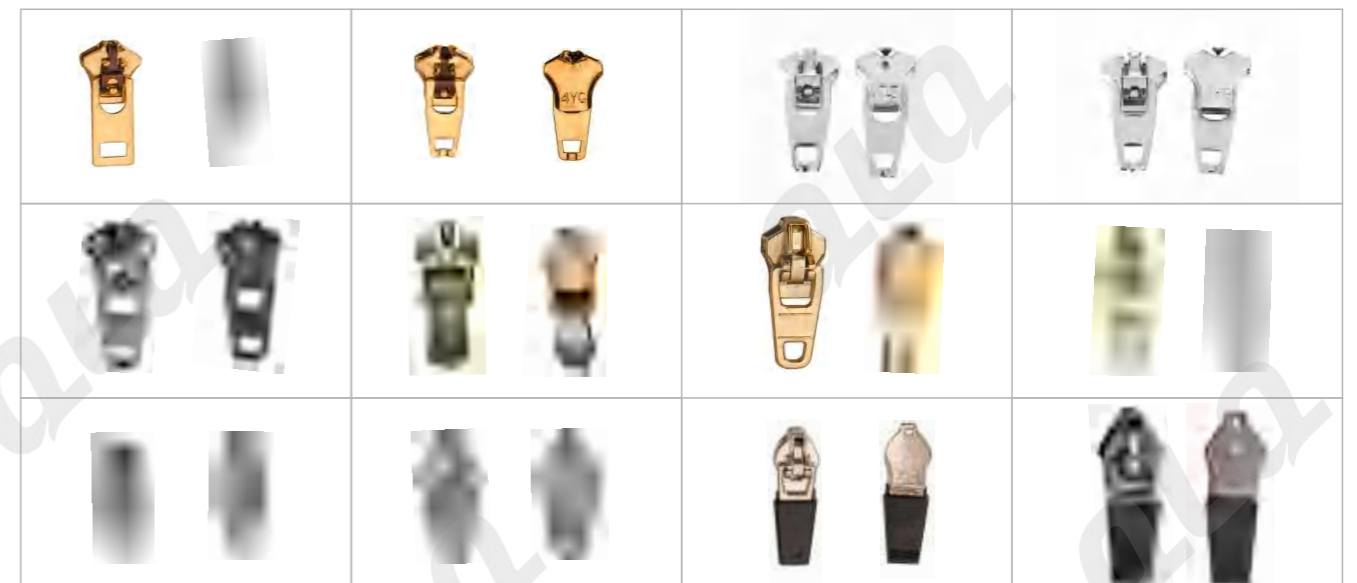

26.3 Non-lock Zinc Slider

锌合金象鼻头/无锁头



26.4 Auto Spring-lock Zinc Slider (3 components)

锌合金弹片式自动拉头(三件套)

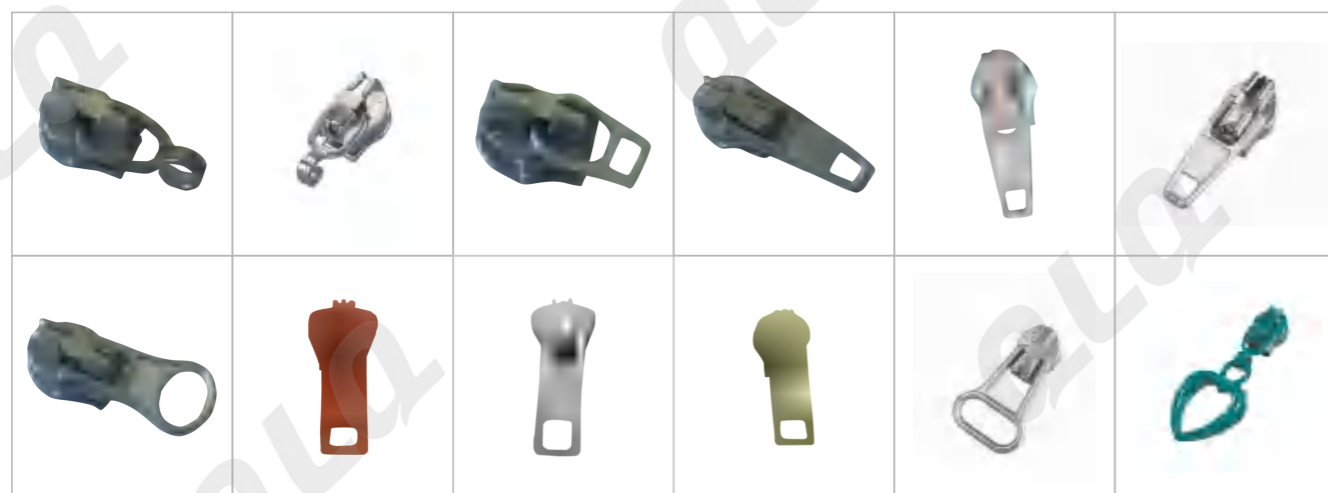

26.5 Auto-lock Zinc Slider (5 components)

锌合金全自动拉头(五件套)

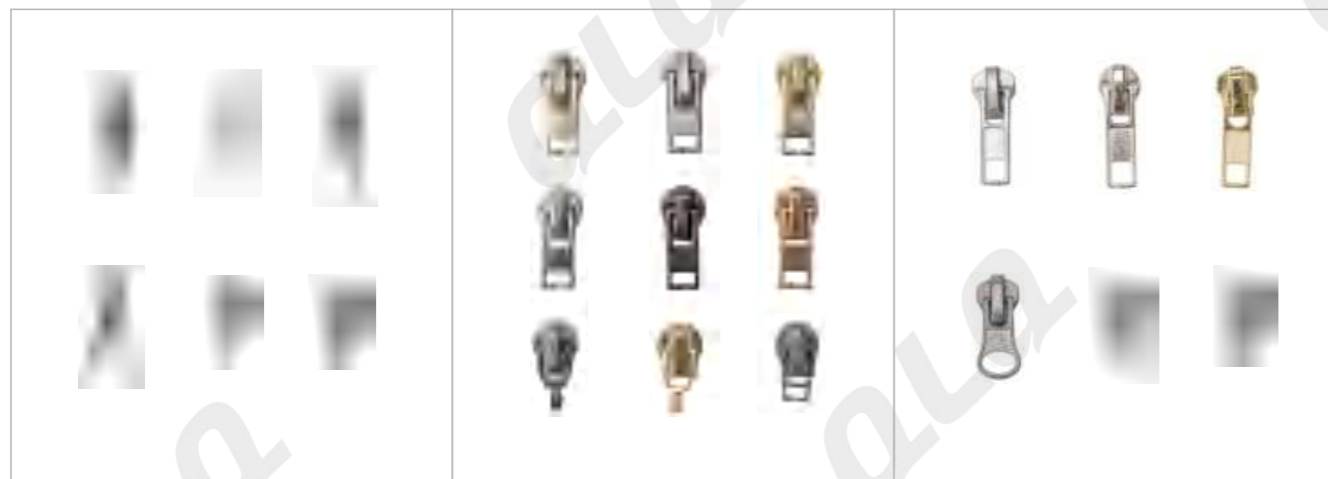

26.6 Invisible Zinc Slider

锌合金隐形拉头



26.7 Italy Type Zinc Slider

锌合金欧款拉头



26.8 Other Type Zinc Slider

其它锌合金拉头



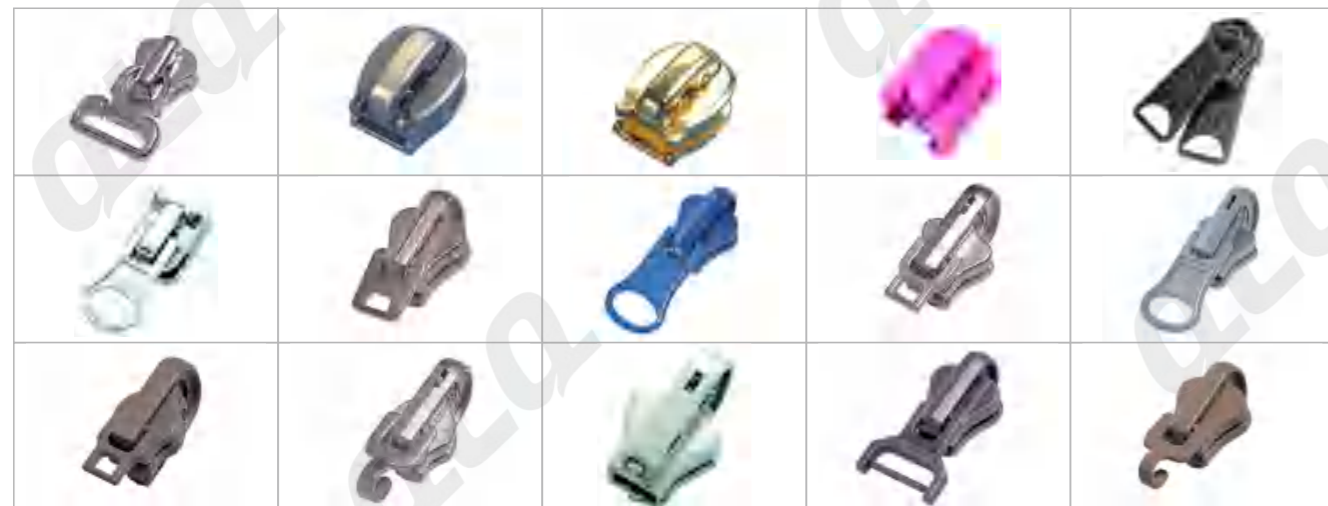

26.9 Zinc Pin Box

锌合金方块插销

 QLQS0594-75 2#金属欧款单拉方块插销	 QLQS0594-1 3#金属背打方块插销	 QLQS0594-11 3#金属双拉分件	 QLQS0594-12 3#金属双拉分件新模	 QLQS0594-79 3#尼龙背打单拉方块插销	 QLQS0594-26 3#尼龙单拉方块插销
 QLQS0594-3 4#金属背打方块插销	 QLQS0594-27 4#尼龙单拉方块插销	 QLQS0594-4 5#金属28KG单拉方块插销	 QLQS0594-21 5#金属侧打仿Y方块插销	 QLQS0594-20 5#金属侧打新款方块插销	 QLQS0594-49 5#金属大欧款单拉方块插销
 QLQS0594-50 5#金属大欧款 两点单拉方块插销	 QLQS0594-72 5#金属欧款M款 单拉方块插销	 QLQS0594-54 5#金属欧款 单拉方块插销	 QLQS0594-28 5#尼龙27KG单拉方块插销	 QLQS0594-35 5#尼龙侧打方块插销	 QLQS0594-34 5#尼龙单拉 方块插销左插
 QLQS0594-39 5#尼龙双拉分件新模	 QLQS0594-52 5#欧款GFY单拉方块插销	 QLQS0594-23 7#金属侧打方块插销	 QLQS0594-7 8#金属背打方块插销	 QLQS0594-24 8#金属侧打方块插销	 QLQS0594-56 8#金属欧款 GFY单拉方块插销
 QLQS0594-55 8#金属欧款Riri单拉方块插销	 QLQS0594-16 8#金属双拉分件	 QLQS0594-37 8#尼龙单拉方块插销左插型	 QLQS0594-42 8#尼龙双拉分件	 QLQS0594-43 8#尼龙双拉新模分件	 QLQS0594-10 10#金属侧打方块插销
 QLQS0594-9 10#金属欧款方块插销	 QLQS0594-8 10#金属网格方块插销	 QLQS0594-44 10#尼龙单拉 方块插销右插型	 QLQS0594-45 10#尼龙单拉 方块插销左插型	 QLQS0594-46 10#尼龙双拉分件	 M12 pin box 12#金属 QLQ-PB41
 M15 pin box 15#金属 QLQ-PB42	 ALPHA QLQ-PB38M10,3 components 10#金属三件套	 8#, brass, 3 components 8#铜三件套	 10#, brass, 3 components 10#铜三件套	 N5, waterproof, normal 5#尼龙防水正插VR QLQ-PB43	
 M2, pin pin 2#金属双开 QLQ-PB64	 M5, pin pin, Y type 5#金属双开仿Y QLQ-PB69	 M7, pin pin 7#金属双开件	 N5, pin pin, Y type 5#尼龙双开仿Y QLQ-PB93	 N7, pin pin, reverse 7#尼龙双开反插 QLQ-PB79	

27 Zipper Tape

拉链布带

 Nylon Zipper Tape 尼龙拉链布带	 Invisible Zipper Tape 隐形拉链布带	 Metal Zipper Tape 金属拉链布带	 Plastic Zipper Tape 塑钢拉链布带
---------------------------------	-------------------------------------	---------------------------------	-----------------------------------

28 Long-chain Zipper

码装拉链

 Nylon Long-chain Zipper 尼龙码装拉链	 Invisible Long-chain Zipper 隐形码装拉链	 Waterproof Long-chain Zipper 防水码装拉链	 Embossing Waterproof Long-chain Zipper 印字/印花防水码装拉链
 PVC Long-chain Zipper PVC码装拉链	 Metal Long-chain Zipper 金属码装拉链	 Plastic Long-chain Zipper 塑钢码装拉链	 Plastic Long-chain Zipper with Shiny Film 贴金银膜塑钢码装拉链
 Plated Teeth for Nylon Zipper 金银牙链条	 Nylon Zipper With Plated Teeth 尼龙电镀牙拉链	 (Stainless Steel) Metal Long-chain Zipper 不锈钢码装拉链	 (Aluminum) Metal Long-chain Zipper 铝码装拉链

29 Finished Zipper

条装拉链

			
Nylon Finished Zipper 尼龙条装拉链	Invisible Finished Zipper 隐形条装拉链	Metal Finished Zipper 金属条装拉链	Plastic Finished Zipper 塑钢条装拉链
			
Embossing Finished Zipper 印花条装拉链	Diamond Finished Zipper 钻石条装拉链	Waterproof Finished Zipper 防水条装拉链	Fire Retardant Finished Zipper 阻燃条装拉链
			
(Stainless Steel) Metal Finished Zipper 不锈钢条装	(Aluminum) Metal Finished Zipper 铝条装拉链	Metallic Plastic Zipper 仿金属胶牙条装拉链	Plastic Magnetic Zipper 胶牙磁吸拉链

30 Button Part

纽扣配件

		
12.9mm	12.9mm	12.9mm
		
15.9mm	15.9mm	15.9mm
		
18.9mm	18.9mm	18.9mm
Stainless Steel Button Shell (without hole) 不锈钢双插壳		
		
Button Shell for Double Feet 双插脚底壳	Stainless Steel Button Shell (with hole) 不锈钢单针	Stainless Steel Flexible Button Part (with hole) 不锈钢活动壳
		
Double Feet 双插脚		

		
12.9mm		
		
15.9mm		
		
18.9mm		
Stainless Steel Fixing Button Part (with white plastic core) 不锈钢固定工字壳(带白胶芯)	Stainless Steel Button Nail 不锈钢钉公	Stainless Steel Button Foot 不锈钢脚仔

31 Bag Accessory

箱包配件

S/N	Sample	Specs	S/N	Sample	Specs	S/N	Sample	Specs
01		6.0X20.5X27.2	13		3.0x10x14.3	25		3.5x12.5x17
02		6.0X22.2X27.2	14		2.8x9.5x13.5	26		3.0x10x14
03		5.0X16X23.6	15		2.3x8x12	27		3.0x11x14
04		5.0X16X23.6	16		1.6x7.5x11	28		3.0x11x14
05		4.5X15X20.5	17		4.4x17x20	29		3.0x10x14
06		4.5X15X20.5	18		4.4x17x20	30		2.8x9.5x13.5
07		4.0X12.5X18.5	19		4.4x17x20	31		2.6x8.5x11.8
08		3.8X13X18.7	20		4.5x14x21	32		2.5x8.5x11.7
09		3.8X12.5X18	21		4.0x14x20	33		2.2x8x10
10		3.8X13X16.3	22		3.5x13x17	34		2.4x8.5x11.8
11		3.4X11X16.3	23		3.5x12x17	35		2.0x7x10.5
12		3.4X11X16.3	24		3.5x11.5x16	36		6.8x30x40

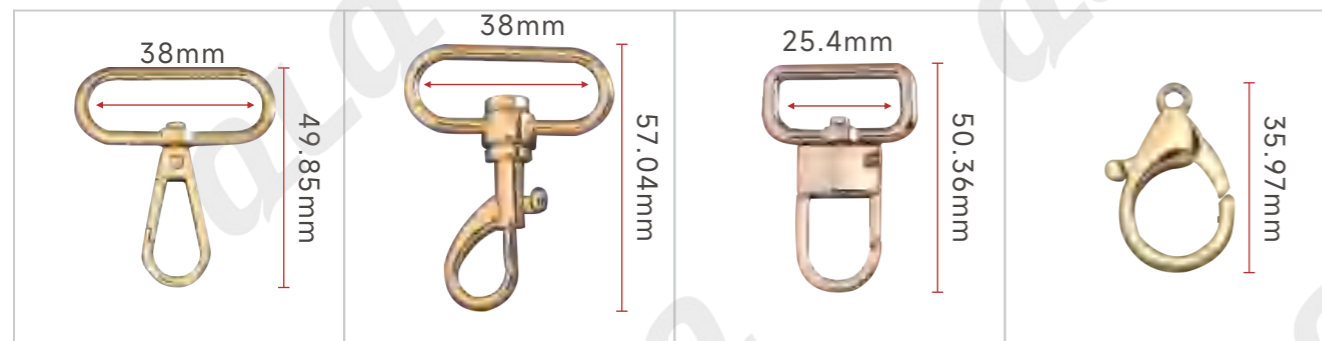

DH-1-11 38mm
Snap Hook (oval)
板扣 1寸半 (蛋)

DH-6-7 38mm
Key Hook
匙扣 1寸半

DH-4-19 25.4mm
Gate/Door Hook (rectangle)
门扣 1寸 (方)

DH-3-6 H:35.97mm
Lobster Hook
龙虾扣



NRR-13 63.5mm
(circle)
2寸半 (圆圈)

SRR-8
38mm (with spring)
1寸半 (弹簧圈)

SRR-9 19.6mm
(rectangle tail, with spring&loop)
内6分 (方形尾弹簧圈4.8T)

SRR-15 25.4mm
(with spring&loop)
1寸 (耳仔弹簧圈4.8T)

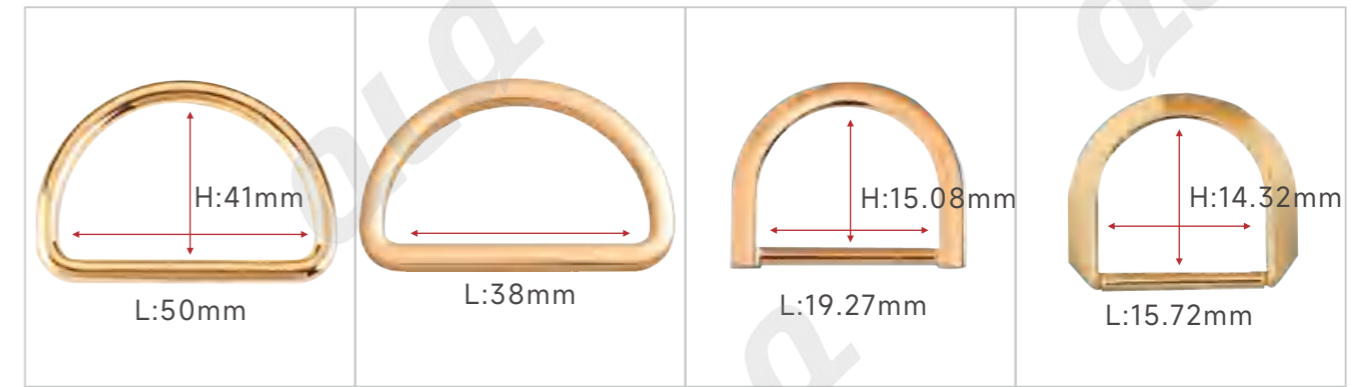

DB-10 50mm
(D buckle)
2寸 (D扣)

DB-15 38mm
(D buckle)
1寸半 (D扣)

DB-24 19.27mm
(D buckle)
6分 (D扣)

DB-28 15.72mm
(D buckle)
5分D (D扣)



SRB-5 33mm
(rectangle shape)
1寸2分*6分 (方扣)

OB-12 38mm
(oval)
1寸半*5分 (蛋扣)

RB-8 32mm
(roller buckle)
1寸2分*1寸 (拉蕊扣)

TGB-9 37.98mm
(tri-glide buckle)
1寸5分6分 (日字扣)



PB-4 32mm
(pin buckle)
1寸2分 (针扣)

PB-20 15.17mm
(flat pin)
5分 (扁针扣)

PB-24 25mm
(semi-circle pin buckle)
1寸 (半圆针扣)

PB-15 19.98mm
(T shape pin buckle)
7分 (T形针扣)

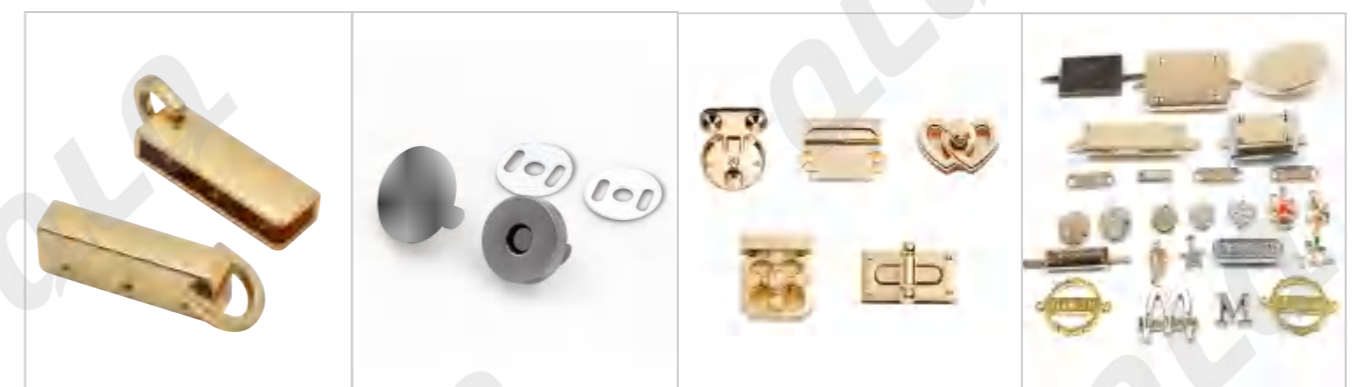

SC-26
42x12mm

MB-3

BL-18

MTL-26

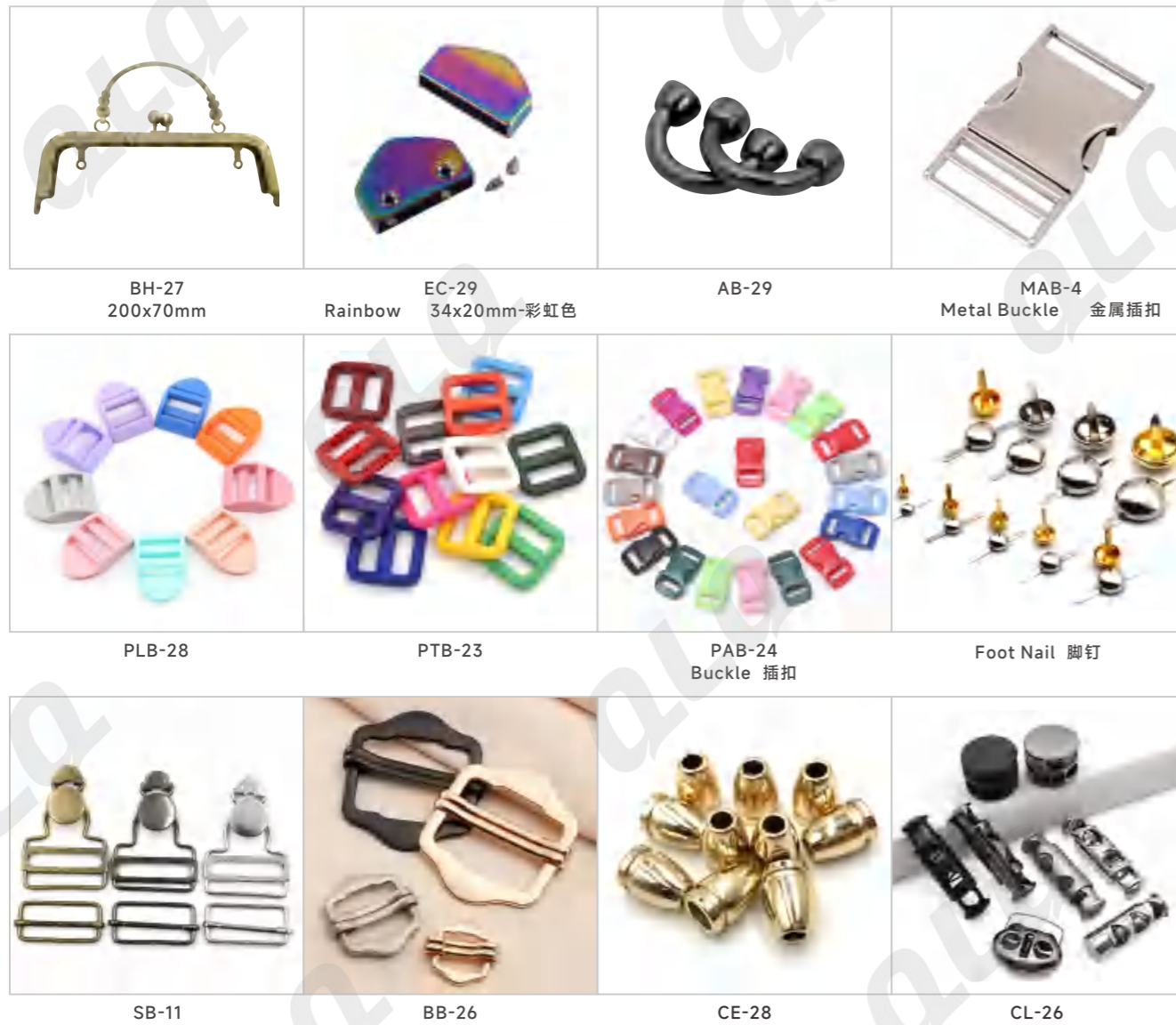

32 Velcro (hook & loop)

粘扣带



33 Chemical for Plating

电镀化工品



Besides above chemicals, we have other chemicals for your choosing.

