

FMS

FLUSH 30

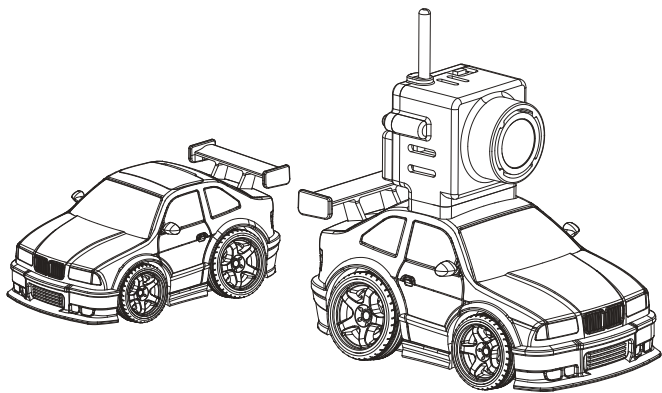

产品使用说明书

本产品不适合于任何14岁以下人士使用。
在使用本产品之前请仔细阅读说明书，并妥善保管。

Instruction Manual

This product contains small parts which are a choking hazard and should not be used by children aged under 14 to avoid accidents.

14+

目录/Contents

- 01** 安全须知/包装内容
功能说明
- 02** 行驶前准备/小车参数
维护与保养
- 03** 遥控功能说明
行驶于转向操作/遥控器按键功能
- 04** 启动遥控 电池更换 - 安装步骤 - 注意事项
车辆连接配对/遥控器参数
- 05** 安装磁吸镜头
眼镜配对镜头
- 06** 故障排除
灯光状态指示
- 07** 非保修条例/注意事项
使用退换货服务需要确认资讯
- 08** FPV眼镜参数
- 09** 控制图/按键功能/菜单设置
视频回放/AV端口说明
- 10** 频段说明 解锁方式 - 关于解锁频率
尺寸示意图/注意事项
- 11** Safety Notice / Package contains
Function Description
- 12** Preparation before running
Product parameters / Maintenance
- 13** Remote control function description
Driving and Steering / Personalized function keys
- 14** Start remote/Car Connection Pairing
Remote controller parameters
- 15** Trolley installation lens
How to match glasses Matching steps
- 16** Troubleshooting
Light status indication
- 17** Non-Warranty Regulations
Precautions
- 18** Product parameters
- 19** Control diagram / Key functions
Menu Instructions / Menu Instructions
AV port Instructions
- 20** Channel Unlocking / Dimension Diagram
Safety instruction

如果您第一次操作遥控车，请花几分钟时间熟悉一下产品各项功能用途。
通过阅读本说明书，了解系统的各种特性后，再开始使用产品。

安全须知

- 本产品内含小零件，有窒息危险，严禁14岁及以下儿童使用，以免发生意外。
- 14岁以上儿童须在监护人在场的情况下使用，且不得离开监护人的视线范围。
- 产品在充电及保存时，请放置在儿童触及不到的地方。
- 可动部件具有一定的危险性，禁止将手指、头发、衣服等物品放入轮胎与车体的空隙间，以免被旋转零件卡住。
- 请严格按照以下使用场景操作：
 - 1、请勿在汽车行驶的场合或幼儿附近操作，以免发生碰撞等危险；
 - 2、请勿在沙地、积水处或有灰尘的地方行驶，以免引起故障；
 - 3、请勿朝著人或者动物行驶，以免发生意外；
- 因功能需要，本品中含有尖锐零部件，请按照正确的步骤及使用方法进行操作，尤其需注意保护眼部安全。
- 请勿弯曲、投掷本产品，或用其他粗暴方式使用，以免损坏本产品或发生意外。
- 本品内置锂聚合物电池，请勿投入水源或者火源中(如火炉、煤气灶等)，以免发生爆炸。

包装内容

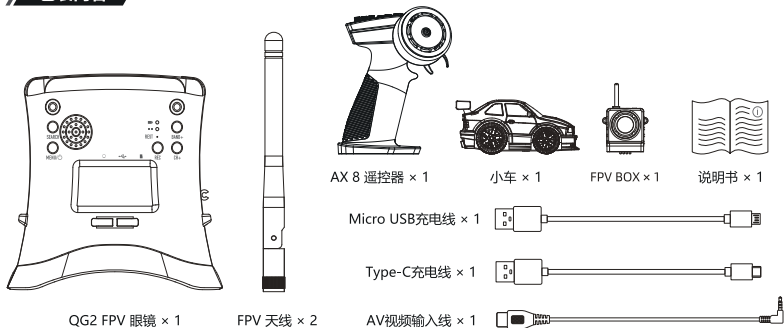

功能说明



右前大灯

左前大灯



后轮可前后转动
左右轮通过转速差实现转向



左尾灯/转向灯

右尾灯/转向灯

行驶前准备

≡充电

从包装盒取出遥控车及配件，在关机状态，使用附带的充电线插入车辆充电孔及USB端口进行充电。
(由于长时间存放，第一次使用遥控车请进行充电操作)。
尾部红灯闪烁，表示正在充电，尾部红灯熄灭，表示充电完成。

提示： 开机状态下，插入充电电源，产品将不能使用。
充电状态下，车辆开关需为关机状态。

- 注意：
- 1、产品充电前，须确保充电插头干燥。
 - 2、产品充电时，请将产品远离易燃区域。
 - 3、请使用USB转TYPE-C(5V)进行充电。

★ 灯光闪烁：正常充电 ☆ 灯光熄灭：完成充电

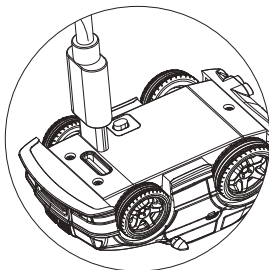

≡开关车辆电源

开机：单击开关后，车头灯亮，转向灯亮。
关机：单击开关后，所有灯熄灭。

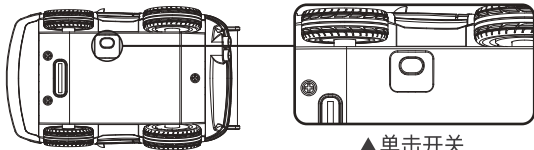

▲ 单击开关

小车参数

基本信息	电机	410 × 2	最小离地间隙	1.5mm
	前轮距	30mm	后轮距	31mm
底盘参数	底盘型号	BUG RACING	驱动方式	后置双电机
	变速箱	Differential steering	前轮胎规格	HT 12 × 4 R10.5
	扭矩比例	1:12	后轮胎规格	HT 14 × 4.5 R12
灯光	大灯	○	氛围灯	○
	刹车灯	○	转向灯	○
	倒车灯	○	FPV Power	4V 2W

维护于保养

- 1、每次产品使用前，检查及清理车轮与底盘间隙的异物，并确保所有部件未松动。
- 2、车辆长时间存放时，应保持70%以上电量进行保存，以延长电池寿命。并且每3个月进行一次充电，以免造成电池损害。(建议充满电并使用20分钟后进行保存为佳)。

≡ 行驶与转向操作

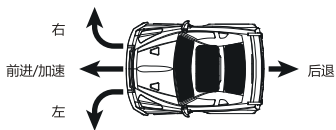
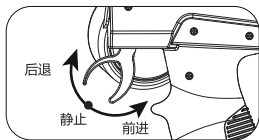
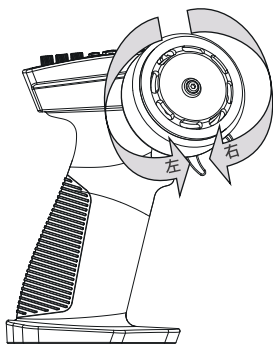

≡ 遥控器按键功能

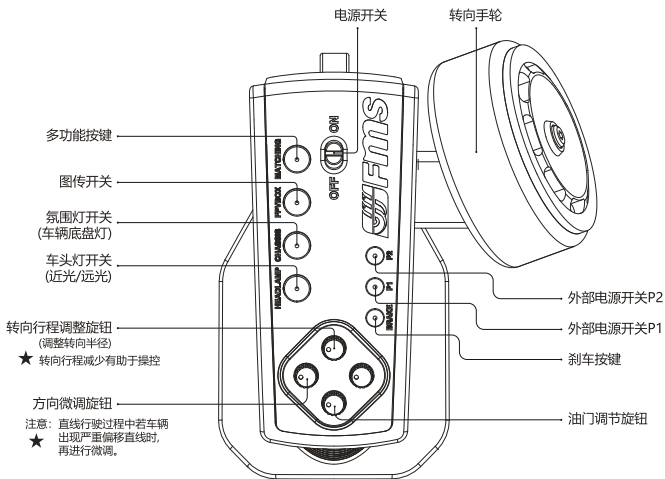

≡遥控器电池安装更换

使用AAA电池×3 或18650×锂电池驱动遥控器。

安装步骤:

- 1、从遥控器底部打开电池盖。
- 2、将AAA电池装入电池卡槽再入电池槽内，
或将18650锂电池直接置入电池槽。
- 3、正常装好电池后盖上电池盖。
- 4、遥控器亮起即可开始使用。

注意事项:

- 1、电池正极需要朝外。(如右图)
- 2、遥控器长时间不用，请取出电池，以免损坏电池。
- 3、请勿尝试通过Type-C电源输出口对遥控器电池进行充电。

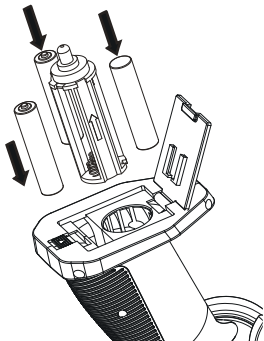

车辆连接配对

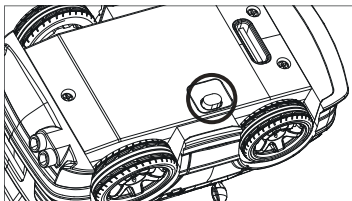

单击开关按键，等待8秒

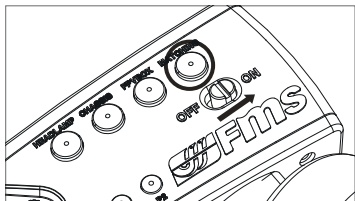

打开遥控器，并长按“多功能键”2秒，将自动配对

≡遥控器配对方式

- 1、打开小车电源，等待8秒钟，尾部黄色灯闪烁，进入配对模式。
- 2、打开遥控器电源，长按“多功能键”2秒，按键灯光闪烁，开始自动配对。
- 3、遥控器按键灯光闪烁停止闪烁，配对成功，开始使用本产品。

遥控器参数

产品名称	多功能遥控器	产品型号	AX 8
工作频率	2.4 Ghz	功能按键	8 通道
遥控距离	30m	电池参数	AAA×3 / 18650锂电池
外形尺寸	106×92×138mm	净重	120g

安装磁吸镜头

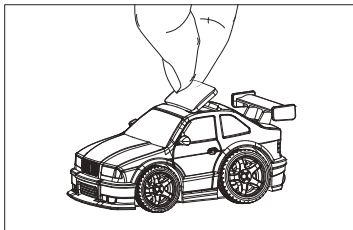

天窗盖是磁吸设计，用手指从天窗边缘打开。

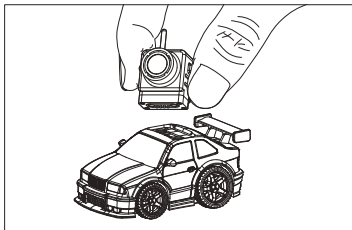

拿开天窗，磁吸摄像头直接朝前放置到金属触点上。

眼镜配对镜头

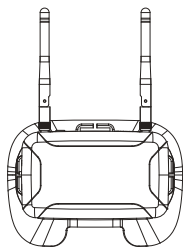

(((5.8G)))

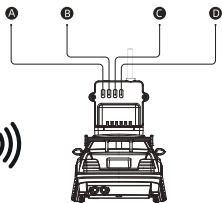

≡配对步骤

- 1、打开遥控车电源(FPV摄像头即可开始工作)
- 2、打开QG2 FPV眼镜电源。
- 3、摄像头背部亮灯位置对应频点A/B/C/D。
- 4、眼镜频点对应调到FPV车显示的频点(切换频点参考8页按键功能)。

短按[SEARCH] 自动搜索(自动搜索选择最强的信号)。

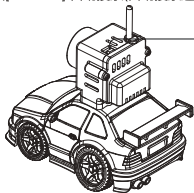

频点切换按键
单击频点切换按键可切换频点。
[(A-B-C-D)循环切换]

★ 多人同时，需使用不同频点。
(相同频点会互相干扰视频信号)。

故障现象	故障原因	解决方法
遥控连接失败	1.距离太远 2.间隔多个墙壁 3.多辆车同时进行遥控配对	请确保产品处于车辆工作模式下（车前灯常亮）。配对距离小于2m并且同时只有一辆车在进行配对
卡顿	车轮间有异物	检查车轮是否有异物
油门扳机回中时，车辆立即前进或后退	油门微调未设置中心位	双击“多功能按键”自动校准油门中位
车辆不能直线行驶/ 左右转向半径明显不同	转向微调未设置中心位	微调转向旋钮（朝左或者朝右）使车轮朝向正前方
不能达到最高车速	1.动力模式 2.电池电量不足 3.车轮间有异物	增加动力模式最大速度，并且检查是否有异物及电池电量是否充足
电机位置发热严重	使用环境温度过高	应马上关闭车辆电源，放置在通风阴凉处进行散热处理，避免电子元件损坏
开机灯不亮	电压低于3.2V, 电量不足	及时充电
停机		

显示	状态
车尾（黄灯）闪烁	等待遥控器与车辆进行配对
车头灯（白光）常亮	遥控器已链接车辆，可进行车辆操作
车头灯（白光）+尾灯闪烁	正在进行充电
前后灯光均熄灭	车辆处于关机状态、电量不足、表示充电完成

非保修条例

- 未经授权的维修、误用、碰撞、疏忽、滥用、进液、事故、改动、不正确的使用非本产品配件,撕毁或涂改防伪标记。
- 已超过三包有效期。
- 因不可抗力造成的损坏。
- 不符合「遥控车产品性能故障表」所列性能故障的情况。
- 因人为原因导致本产品及其配件产生「遥控车产品性能故障表」所列性能故障。

注意事项

- 车辆内含锂电池，禁止拆解、撞击、挤压或投入火中。
若出现严重鼓胀,请勿置于高温环境中使用。
- 因锂电池性质特殊，环境温度过高过低都会影响电池充放电性能和续航时间，故请勿在高温、低温、高湿、阳光直射等环境使用及保管本产品。
- 须定期检查其充电线、插头、外壳及其他部件是否损坏，若发现损坏时应停止使用,直至修复完好。
- 当车辆电池电压低于3.2V时会自动切断电流，车辆停止所有功能，以保护电池。
- 高压电线、轻轨、微波炉等产生相同频率的电波，导致产品不能正常操作，请更换位置或另择时间再操作。
- 若由于操作失误而导致他人受伤或物品损坏等事故，均属于操作者的责任，本公司概不负责。

使用退换货服务需要确认资讯

用户退换货申请时，需要按照智能遥控车保修说明跟客服确认是否符合售后条件并进行相关售后安排。

提示：

说明书中的产品、配件、遥控器均为示意图，仅供参考。
由于产品的更新与升级，产品实物与示意图可能略有差异，请以实物为准。

QG2 FPV GOGGLES



产品参数

产品名称	QG2 FPV 第一视角眼镜			
液晶屏	屏幕大小:	4.3英寸	屏幕比例:	16:9
	分辨率:	800X480	显示角度:	六点钟方向
	亮度:	500cd/m ² , 高亮度背光LED		
视频延迟	视频延时小于0.01秒			
镜头	2.8X 菲涅尔透镜, 92% 透光率, 观感舒适			
接口	天线:	2 XRP-SMA公头	AV信号输入显示:	内部AV信号输出共享
	USB:	给电池充电	卡槽:	TF卡, 最大支持32G (建议C10规格的内存卡)
录像功能	帧速率:	30 帧	录制分辨率:	VGA / D1 / HD (可调整)
	图片格式:	MJPEG	录制声音:	开 / 关 (可调整)
	视频格式:	AVI	录制时间:	关/3/5/10分钟 (可调整)
语言	英文和中文			
整体	外观尺寸:	155×144×113mm	重量:	300g (不含天线重量)
电源	电源适配器: DC 5V/2A (USB接口)			
	电池: 3.7V / 2000 mAh (内置电池最大充电电流500mA) 录制功能打开时: 充满电工作时间约2.5小时 录制功能关闭时: 充满电工作时间约3.5小时			

控制图

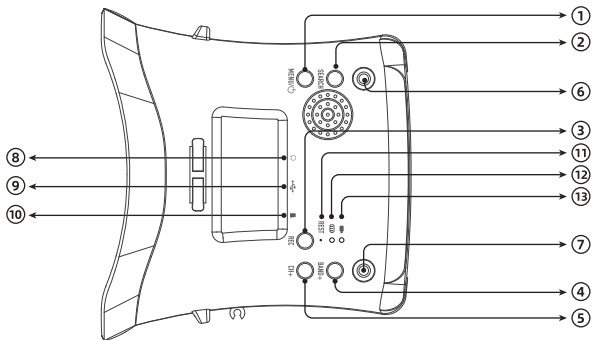

按键功能

- 1 [MENU/ \odot] : 短按[MENU/ \odot]进入菜单;长按[MENU/ \odot]开机/关机。
- 2 [SEARCH] : 短按[SEARCH] 自动搜索;长按[SEARCH] 进入AV模式。
- 3 [REC] : 短按[REC]开始/停止视频录制。
- 4 [BAND +] : 短按[BAND +] (切换频段 A - B - E - F - R)。
- 5 [CH+] : 短按[CH+] (切换频率 1 - 2 - 3 - 4 - 5 - 6 - 7 - 8)。
- 6 天线接口A: RP-SMA公接口。
- 7 天线接口B: RP-SMA公接口。
- 8 AV Jack: 在AV模式下可以输入视频信号。
- 9 Micro-USB充电接口: 支持DC 5V输入。
- 10 TF卡槽: 用于插入储存卡。
- 11 重置: 恢复出厂设置。
- 12 充电指示灯: 充电时亮红灯, 满电时亮绿灯。
- 13 REC指示灯: DVR工作状态。

菜单设置

按[MENU/ \odot]进入菜单栏。

菜单栏模式下按键功能变化:

- | | |
|---------------------|---------|
| ① [MENU/ \odot] | 设置选项; |
| ② [SEARCH] | 自动搜索; |
| ③ [REC] | 无功能; |
| ④ [BAND+] | 调节+1确认; |
| ⑤ [CH+] | 调节-; |

视频回放

按[MENU/ \odot]进入菜单栏。

进入菜单栏后选中“回放”，短按[BAND+]进入。

- | | |
|---------------------|----------------------|
| ① [MENU/ \odot] | 返回/退出播放模式; |
| ② [SEARCH] | 删除当前文件; |
| ③ [REC] | 播放/暂停; |
| ④ [BAND+] | 视频前进选择/快进(当视频播放时); |
| ⑤ [CH+] | 向后选择视频/快速倒带(当视频播放时); |

AV端口说明

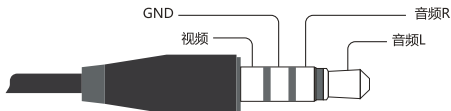

频段说明

A	B	C	D
5865	5825	5785	5745

注: 本产品默认使用以上4个频点。

如果需要使用其他频率, 需要先对产品进行解锁。

解锁方式: 同时长按“Band+”与“Ch+”按键3秒, 即可解锁(下图所有频点)

关于解锁频率: 解锁频率前请先了解当地法律法规, 以免出现违反其规定的行为。

本公司仅提供设备, 对其违反规定的行为概不负责!

频率表(MHz)

	频点 1	频点 2	频点 3	频点 4	频点 5	频点 6	频点 7	频点 8
频段 A	5865	5845	5825	5805	5785	5765	5745	5725
频段 B	5733	5752	5771	5790	5809	5828	5847	5866
频段 E	5705	5685	5665	5645	5885	5905	5925	5945
频段 F	5740	5760	5780	5800	5820	5840	5860	5880
频段 R	5658	5695	5732	5769	5806	5843	5880	5917

尺寸示意图

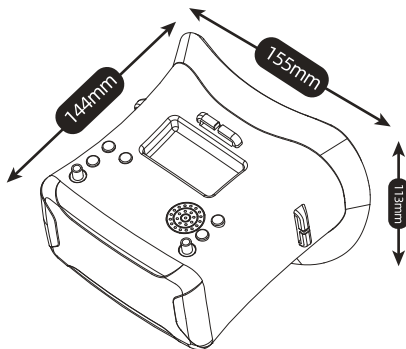

注意事项

1. 阅读完使用说明书, 熟悉产品功能后再进行操作。
2. 本产品适用年龄: 14岁以上青少年。(长期使用此产品会导致眼睛疲劳, 请注意休息!)
3. 勿将产品置于潮湿的环境, 以免造成电子元件损坏。
4. 请使用标准5V USB充电器, 更高的电压将可能损坏本产品。
5. 音频输出和视频输入不能同时工作。

Please read the manual to the end to gain maximum benefit from this product.

Safety Notice

- It is strictly prohibited for children aged 14 and under to use it to avoid accidents.
- Children aged 14 and above must use it in the presence of a guardian.
- Please keep the product out of reach of children during charging and storage.
- The components have a certain degree of danger, and it is prohibited to place items such as fingers, hair, clothes, etc. in the gaps of the tires to avoid getting stuck due to rotation.
- Please strictly follow the following usage scenarios:
 1. Do NOT operate near very small children and pets.
 2. DO NOT operate on sand, wet or dusty surfaces.
 3. DO NOT operate anywhere you are likely to cause harm to pets, people, and property.
- Please follow the correct steps and usage methods for operation, especially paying attention to eye safety.
- Do not bend, throw, or use this product in other rough ways to avoid damage or accidents.
- This product has a built-in lithium polymer battery, avoiding wet and hot surfaces.
Battery exposed to great heat can explode.

Package contains

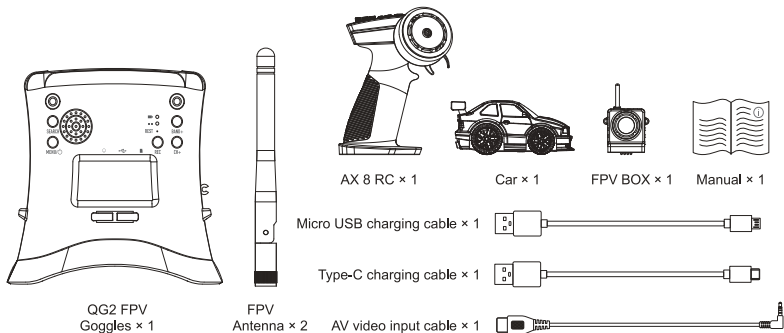

Function Description

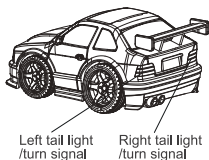
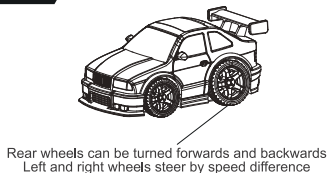
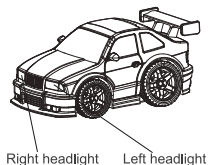

Preparation before running

≡ Charge

Due to long-term storage, please charge the remote control car for the first time (Use the included charging cable to plug into the vehicle charging port and USB port for charging.)

The tail red light flashes to indicate charging, while the tail red light goes out to indicate charging is complete.

Tip: To charge the car, the power must be turned off, and the car cannot be used when turned on.

- Notice:**
1. Before charging the product, make sure the charging plug is dry.
 2. When charging the product, please keep the product away from the flammable area.
 3. Please use USB to TYPE-C (5V) for charging.

★ Light flashing: Normal charging. ☆ Lights off: Charging complete.

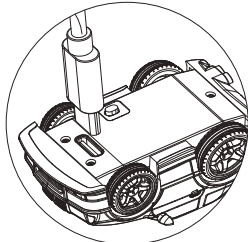

≡ Turn on and off the car power

Turn on: After clicking the switch, the headlights and turn signals will turn on.

Shutdown: After clicking the switch, all lights turn off.

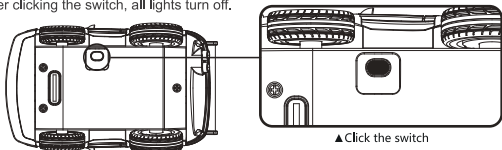

Product parameters

Basic Information	Motor	410 × 2	Ground clearance	1.5mm
	Front track	30mm	Rear track	31mm
Chassis Parameters	Chassis model	BUG RACING	Drive mode	Rear dual motor
	gearbox	Differential steering	Front tire Spec	HT 12 × 4 R10.5
	Torque ratio	1:23	Rear tire Spec	HT 14 × 4.5 R12
Light	Headlights	○	Ambient Light	○
	Brake light	○	Turn signal	○
	Reversing lights	○	FPV Power	4V 2W

Maintenance

1. Before each use of the product, check and clean the foreign matter in the gap between the wheel and the chassis, and ensure that all parts are not loose.
2. When the Car is stored for a long time, more than 70% of the power should be kept for storage to prolong the battery life, and every 3 months, One charge to avoid battery damage. (It is recommended to fully charge it and use it for 20 minutes before saving it).

Remote control function description

≡ Driving and Steering

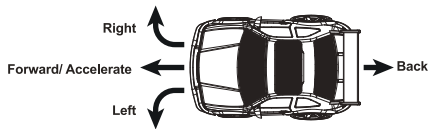
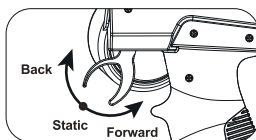
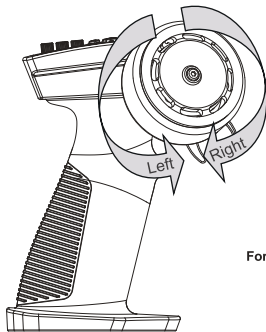

≡ Personalized function keys

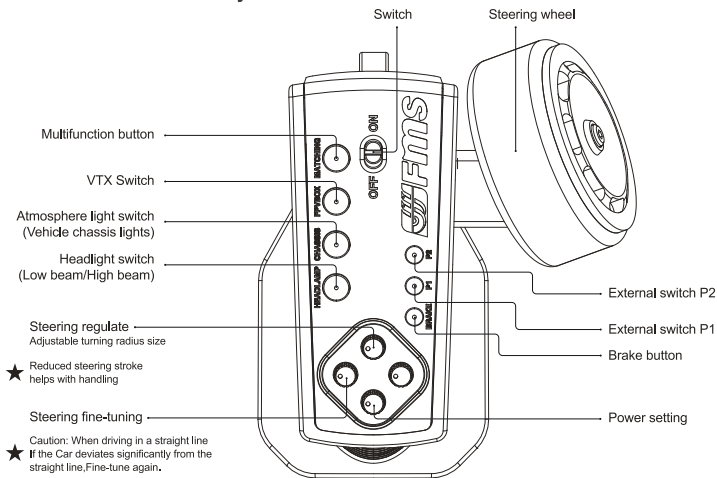

Start remote

Remote control battery installation and replacement

Using AAA batteries × 3 or 18650 lithium battery driven remote control.

Installation steps:

1. Open the battery cover.
2. Insert the AAA battery into the battery card slot and then into the battery slot. Or put the 18650 lithium battery directly into the battery slot.
3. Install the battery cover onto the battery cover.
4. When the remote control lights up, it can be used.

Precautions:

1. The positive pole of the battery needs to face outward. (As shown in the right picture)
2. If the remote control is not used for a long time, please remove the battery to avoid damage to the battery.
3. RC batteries cannot be charged through the Type-C power output port.

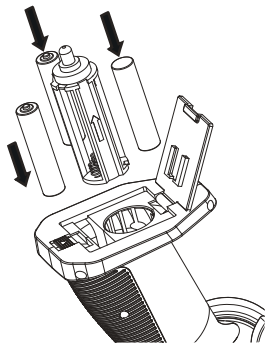

Car Connection Pairing

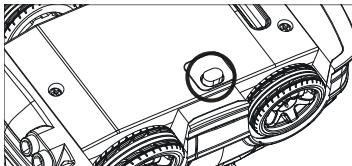

Click on the switch button and wait for 8 seconds

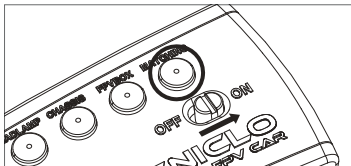

Turn on the remote control, and press and hold the "multi-function button" for 2 seconds, it will be paired automatically

Remote control pairing method

1. Turn on the power of the car, wait for 8s, the yellow light at the rear flashes, and enter the pairing mode.
2. Turn on the power of the remote control, press and hold the "Multi function button" for 2s, the button light flashes, and automatic pairing begins.
3. The remote control button light flashes and stops flashing. The pairing is successful, and you can start using this product.

Remote controller parameters

Product name	Multifunctional remote control	Product number	AX 8
Working frequency	2.4 Ghz	Function button	8 channels
Remote control distance	30m	Battery Parameters	AAA×3 / 18650 lithium battery
Dimensions	106×92×138mm	Weight	120g

Trolley installation lens

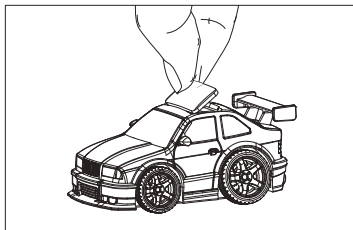

The sunroof cover has a magnetic design,
Remove the sunroof easily.

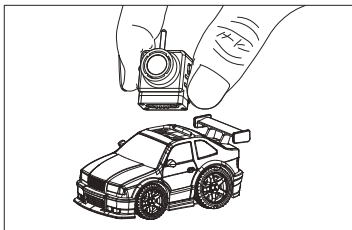

Remove the sunroof and place the magnetic camera
directly forward on the metal contact.

How to match glasses

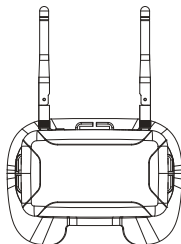

5.8G

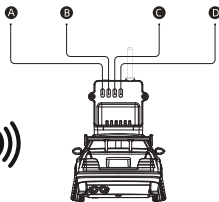

≡ Matching steps

1. Turn on the car power (the FPV camera starts to work).
2. Power on the QG2 FPV glasses.
3. The light position on the back of the camera corresponds to the frequency point A/B/C/D.
4. The frequency point of the glasses corresponds to the frequency point displayed by the FPV car (refer to the button function on page 8 for switching frequency point).

Short press **[SEARCH]** to automatically search
(automatic search selects the strongest signal).

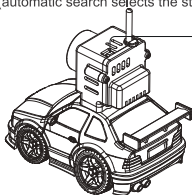

Frequency switch button Click the frequency switch button
to switch the frequency. [(A-B-C-D) cycle switch]

- ★ When multiple people play at the same time,
they need to use different frequency points.
(The same frequency points
will interfere with each other video signal).

Troubleshooting

Fault phenomenon	Cause of issue	Solution
Remote control connection failed	<ol style="list-style-type: none"> 1. Too far away 2. Space multiple walls 3. Remote control pairing for multiple Cars at the same time 	Please ensure that the Car is in operating mode (headlights are on). Pairing distance is less than 2M and only one Car is being paired at the same time.
Stuck and stopped	Foreign object between wheels	Check the wheels for foreign objects
When the throttle is in neutral position, the car immediately starts to move forward or backward	Throttle trim is not set to center	Double-click the "multi-function button" to automatically calibrate the throttle neutral position
The Car cannot drive in a straight line/ The left and right steering radii are significantly different	Steering trim not set center	Fine tune the steering knob (facing left or right) Orient the wheels straight ahead
Can't reach top speed	<ol style="list-style-type: none"> 1. Power mode 2. Low battery 3. There is a foreign object between the wheels 	Increase the maximum speed of power mode, and check whether there is foreign matter and whether the battery power is sufficient
Serious heat at the motor position	The ambient temperature is too high	Turn off the power of the Car immediately and place it in a ventilated and cool place for heat dissipation to avoid damage to electronic components
Turn on light is off	Voltage below 3.2V, low battery	Recharge in time
downtime		

Light status indication

Show	State
Rear (yellow light) flashing	Wait for the remote to pair with the Car
Headlights (white light) always on	The remote control has been linked to the Car and can operate the Car
Headlights (white light) + flashing red tail light.	Charging in progress
Front and rear lights are off	Car is switched off, low battery, indicates charging is complete.

Non-Warranty Regulations

- Unauthorized maintenance, misuse, collision, neglect, abuse, liquid ingress, accident, alteration, improper use of non-product accessories, tearing or altering of security markings.
- The validity period of three Guarantees (Return/Exchange/Fix) has exceeded;
- Damage caused by force majeure.
- Not in line with the performance failures listed in the 「 Remote Control Car Product Performance Failure Table 」 .
- The product and its accessories have performance failures listed in the 「 Remote Control Car Product Performance Failure Table 」 due to human reasons.

Precautions

- This product contains small parts, which pose a choking hazard and are not suitable for children under the age of 14.
- This product is strictly prohibited for children under the age of 14 to avoid accidents. Children over the age of 14 must use it in the presence of a guardian, and must not leave the guardian's line of sight. When charging and storing the product, please keep it out of the reach of children.
- Moveable parts are dangerous to some extent. It is forbidden to put fingers, hair, clothes, etc. into the gap between the tire and the Car body, so as not to be caught by the rotating parts.
- Please operate in strict accordance with the following usage scenarios:
 1. Do not operate in the place where the car is driving or near children, so as to avoid dangers such as collision;
 2. Do not drive on sand, water or dusty places to avoid malfunctions;
 3. Do not drive towards people or animals to avoid accidents;
- Because of functional requirements, this product contains sharp parts, please follow the correct steps and use methods, especially pay attention to eye safety. Do not bend, throw this product, or use it in other rough ways to avoid damage to this product or accident.
- This product has built-in lithium polymer battery, please do not put it into water or fire (such as stove, gas stove, etc.) to avoid explosion.

Confirmation information is required to use the return service

When the user applies for return or replacement, he needs to confirm with the customer service according to the warranty instructions of the car. Whether it meets the after-sales conditions and makes relevant after-sales arrangements.

Hint:

1. The products, accessories and remote control in the instruction manual are schematics for reference only.
2. Due to products update and upgrade, the actual products may differ slightly from the schematic, please refer to the actual products.

QG2 FPV GOGGLES



Product parameters

Name	QG2 FPV Goggles			
LCD Screen	Screen size:	4.3 Inch	Display Ratio:	16:9
	Resolution:	800 × 480	View Angle:	6 o'clock
	Brightness:	500cd/m ² with high brightness backlight LED		
Video delay	Video time-delay less than 0.01ms			
Lens	Video time-delay less than 0.01ms			
Interface	Antenna:	2 X RP-SMA male	AV Jack:	AV signal input display
	USB:	To charge the battery	Card slot:	TF-Card, Support up to 32G(C10 recommend)
DVR	Frame rate:	30 Frames	30 Frames	VGA / D1 / HD (Selectable)
	image format:	MJPEG	REC Sound:	ON / OFF (Selectable)
	Video format:	AVI	REC time:	OFF/3/5/10min (Selectable)
Languages	English and Chinese			
Body	Dimension:	155×144×113mm	Weight:	300g (Without antenna)
	Power adapter: DC5V/2A (USB interface)			
Power Supply	Battery: 3.7V/2000mAh (Built-in battery maximum charge current of 500mA)			
	DVR module ON: Each full charge revive around 2.5hr working time			
	DVR module OFF: Each full charge revive around 3.5hr working time			

Control diagram

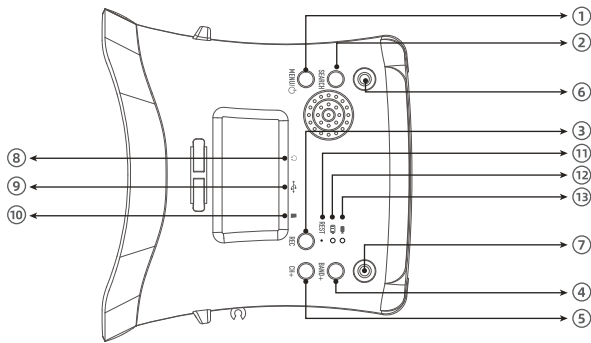

Key functions

- ① Short press into MENU mode; Long press (> 2S) for Power ON/OFF.
- ② Short press for Auto-Searching; Long press (> 1.5S) into AV mode.
- ③ Short press to start or stop Recording
- ④ Short press for Band+ (Change bands AB-E-F-R circularly).
- ⑤ Short press for Channel+ (Change channels 1-2-3-4-5-6-7-8 circularly).
- ⑥ Antenna port A: RP-SMA male.
- ⑦ Antenna port B: RP-SMA male.
- ⑧ AV Jack: Video signals can be input in AV mode.
- ⑨ Micro-USB Charging port: Supports DC5V only.
- ⑩ Card slot: Used for inserting memory card.
- ⑪ RESET: Power Reset.
- ⑫ Charging indicator: When is charging, the red light is on When is full, the green light is on.
- ⑬ REC indicator: Show the different working states of the DVR module.

Menu Instructions

In the normal mode,
Press Key 1 to enter the MENU mode.

- ① Key 1: Scroll options bar.
- ② Key 2: Auto-Searching.
- ③ Key 3: Invalid.
- ④ Key 4: Enter / Value+.
- ⑤ Key 5: Enter / Value-.

Menu Instructions

In the menu mode, select the "DVR" option
bar to enter the DVR mode.

- ① Key 1: Return 1 Quit Playback mode.
- ② Key 2: Delete current file.
- ③ Key 3: Play / Pause.
- ④ Key 4: Forward selection of video / Fast Forward.
- ⑤ Key 5: Backward selection of video / Fast Rewind .

AV port Instructions

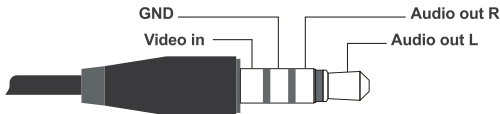

Channel Unlocking

A	B	C	D
5865	5825	5785	5745

Note: This product uses the above 4 frequency points by default. If you need to use other frequencies, you need to unlock the product first.

Unlocking method: Press and hold the **"Band+"** and **"Ch+"** buttons for 3 seconds at the same time to unlock. (all frequency points in the picture below)

About unlocking frequency

Please understand local laws and regulations before using this product, so as to avoid behaviors that violate their regulations. The company only provides equipment and is not responsible for its violations!

FrequencyTable(MHz)

	CH 1	CH 2	CH 3	CH 4	CH 5	CH 6	CH 7	CH 8
Band A	5865	5845	5825	5805	5785	5765	5745	5725
Band B	5733	5752	5771	5790	5809	5828	5847	5866
Band E	5705	5685	5665	5645	5885	5905	5925	5945
Band F	5740	5760	5780	5800	5820	5840	5860	5880
Band R	5658	5695	5732	5769	5806	5843	5880	5917

Dimension Diagram

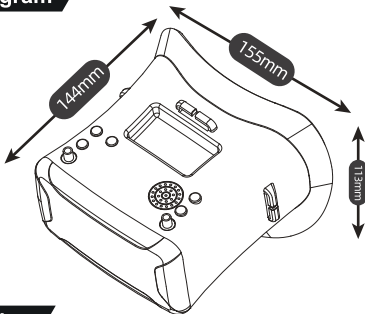

Safety instruction

1. After reading the instruction manual and familiar with the function of the product, operate it.
2. This product is suitable for young people over 14 years old.
(Long-term use of this product can cause eye fatigue, please take a break!)
3. Do not place the product in a humid environment to avoid damage to electronic components.
4. Please use a standard 5V USB charger, higher voltage may damage the product.
5. Audio output and video input cannot work at the same time.

CAUTION | 注意

本产品由精密部件组成，并非玩具，因此不适合 14 岁以下的少年或儿童使用。未成年人操作时应有成人陪同。未能以安全的方式操作或维护本产品可能会导致人身伤害或财产损失。本品操作者对其行为为全权负责。务必选择合适的环境操作遥控模型。所选环境需远离公共道路、密集人群、电缆、无线电塔等。

- This product is NOT a toy, thus it is not suited for children under 14 years of age.
Minors should be accompanied by an adult when operating.
- Warnings listed in the instructions must be read carefully.
- Improper adjustments and operation will result in crashes and damage to the item.
- Experience is required prior to handling this product.

Fax: +86-0757-29955904 Tel: +86-0757-29955904

E-mail: support@fmsmodel.com

Add: Unit A, Building 6, Jicheng Science and Technology Innovation Park, Shunde,
Foshan City, Guangdong Province, 528306

Foshan Zhengze Model Technology Co., Ltd.

电话: 86-0757-29955904

邮箱: support@fmsmodel.com

地址: 广东省佛山市顺德区北滘镇陈江社区三乐东路25号集成科创园 6栋

生产企业: 佛山市正泽模型科技有限公司



MADE IN CHINA

" ENJOY DRIVING PLEASURE, "
START YOUR CHAMPION ROAD.