

iHoverboard

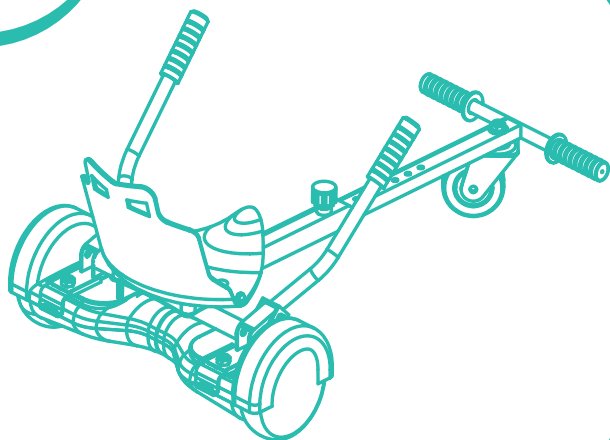

K3
Hoverboard Seat

USER MANUAL

CONTENTS

1. Riding Safety	1
2. Service and Warranty	2
3. Packing List	2
4. Assembly Introduction	3

NEED HELP??

**Please contact us:
support@ihoverboard.com**



1. The hoverboard kart has been designed as a recreational product. Before mastering riding skills, you need to practice. iHoverboard is not responsible for any injuries or damage caused by a rider's inexperience or failure to follow the instructions in this document.
2. Please understand that you can reduce the risk by following all the instructions and warnings in this manual, but you cannot eliminate all the risks. Remember that whenever you ride the hoverboard kart you risk injury or death from loss of control, collisions, and falls. When entering public spaces always comply with the local laws and regulations. Be cautious and always keep a safe distance between you and other people or vehicles when riding. Be alert and slow down when entering unfamiliar areas. Users are responsible for following all local, state, and federal laws regarding the use of this product.
3. Make sure each new rider wears a helmet and other protective gear. Do not ride with high heels. Always ride with properly strapped closed-toe shoes.
4. Do not attempt your first ride in any area where you might encounter children, pedestrians, pets, vehicles, bicycles, or other obstacles and potential hazards.
5. Parental/adult supervision is necessary with children under 12. If you are under 18, please get your parent's permission.
6. The safety speed is 6.2mph. When the speed is over 7.5mph, the kart will be out of control for 0.3-0.5s and the user can't apply the brakes immediately.
7. The hoverboard kart is not for users weighing less than 44lbs than 44lbs/20kg or more than 270lbs/120kg. The maximum weight limit of 270 lbs (120 kg) includes items that might be worn or carried such as backpacks, clothes, or personal items. Failure to adhere to the minimum and maximum weight limits can cause personal injury to the user and damage to the hoverboard kart.
8. Before each ride check for loose fasteners, and damaged components. If the hoverboard makes abnormal sounds or signals an alarm, immediately stop riding.
9. Never ride at high speeds on uneven terrain or slopes. Never ride in the dark, or dimly lit areas. Do not ride in the snow, in the rain, or on roads that are wet, muddy, icy, or that are slippery for any reason. Do not ride over obstacles (sand, loose gravel, or sticks). Doing so could result in a loss of balance or traction and could cause a fall. Never ride backward for long distances or at high speeds.















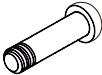

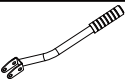

SERVICE AND WARRANTY

1. The warranty period is consistent with the national and local warranty policy. The warranty period is calculated from the date of purchase by the user (on the basis of the date on the purchase receipt).
2. Maintenance costs beyond the warranty period and beyond the scope of the warranty only incur maintenance costs.
3. If there is any help or accessory replacement needed, please try to send messages to [ihoverboard: support@ihoverboard.com](mailto:ihoverboard:support@ihoverboard.com)



PACKING LIST

Tools Name	Photo		
		4* Screws of handles (A)	
1*Frame (2 parts)		8* Nuts (B)	
1*Adjustment knob		2*Screws of the frame (C)	
4*Velcro straps		4*Large washers (D)	
2* Bases		4*Black washers (E)	
2* Handles		4*Screws of the seat (F)	
1* Wheel nut		4*Small washers (G)	
1*Kart seat		1*Wrench	
2*Gasket		1*Allen wrench	



ASSEMBLY INTRODUCTION

1. Install the handles on the bases on both sides with screws of handles (A) and nuts (B).

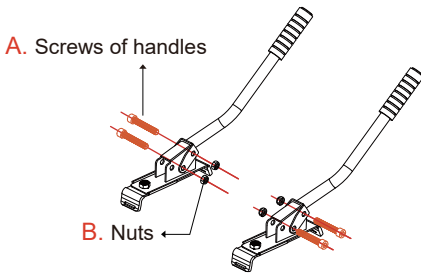

2. Install the whole handles on the frame on both sides with screws of the frame (C), large washers (D), and black washers (E).

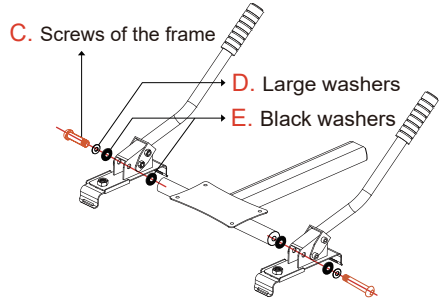

3. Fasten the adjustment knob into the hole to connect the front frame and back frame.

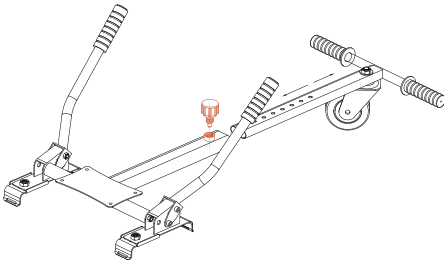

4. Install the seat on the frame with screws of the seat (F) and small washers (G).

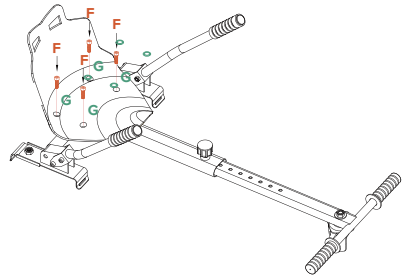

5. Adjust the slidable metal plates to fit your hoverboard size, then fasten the nut tight. Put and adjust the velcro straps tight.

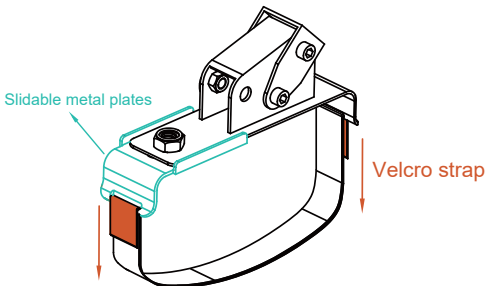

6. Your kart is ready to go.

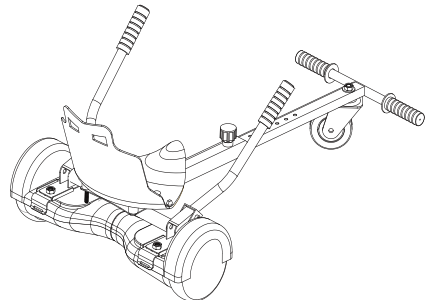

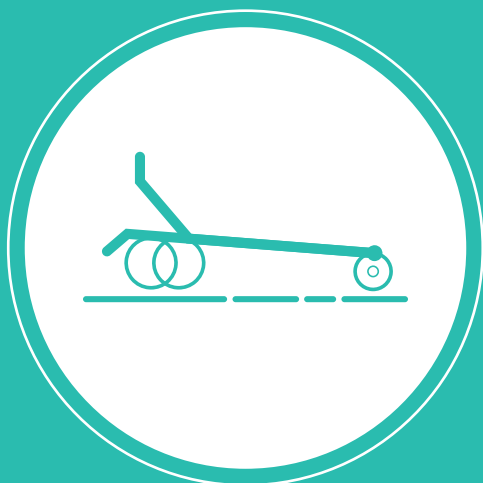

The manufacturer reserves the right to make changes to the product,
and update this manual at any time.
www.ihoverboard.com