

**A-Left Panel** 1PC

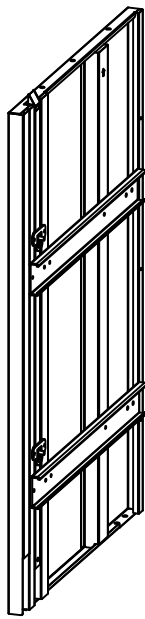

**B-Right Panel** 1PC

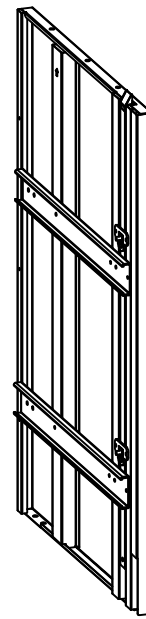

**C-Underside Frame** 1PC

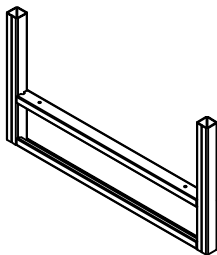

**D-Back Panel** 1PC



**E-Top Panel** 1PC

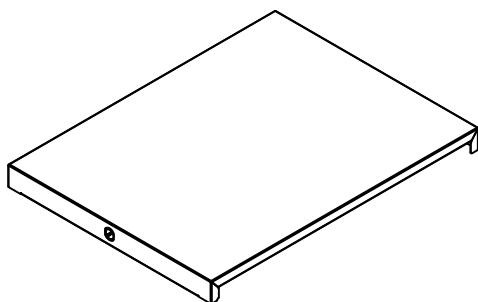

**F-Drawer Front Panel** 2PCS

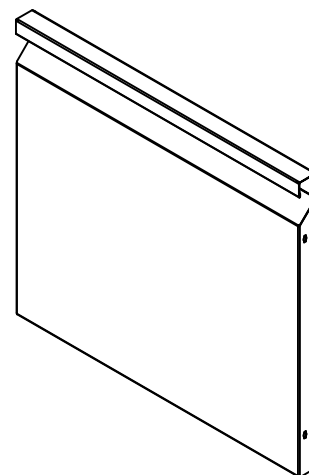

G-Drawer Chest

2PCS

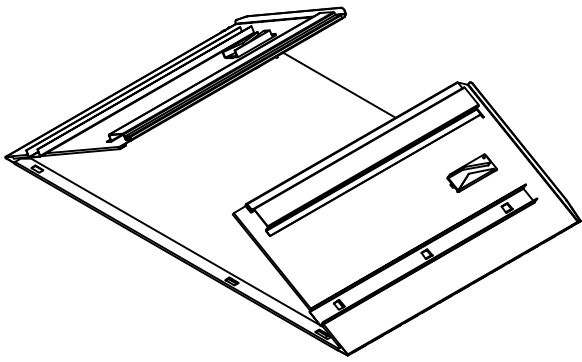

I

2PCS

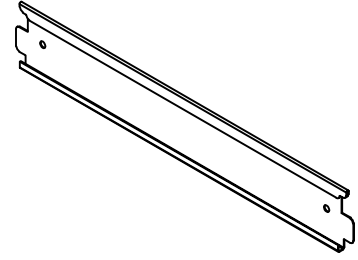

K

4PCS

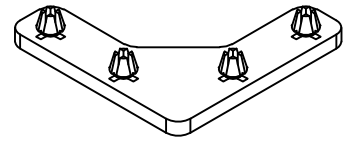

H-Drawer Back Baffle

2PCS

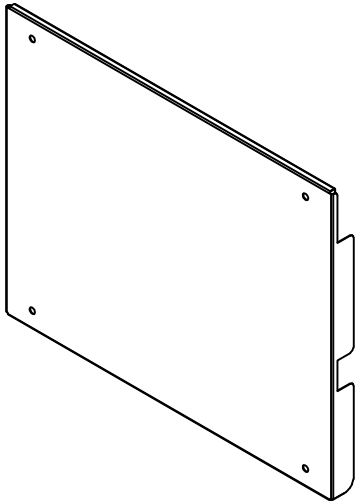

L

14PCS

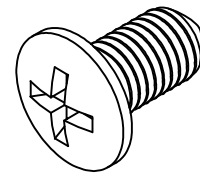

### Schematic diagram of slider removal

Left

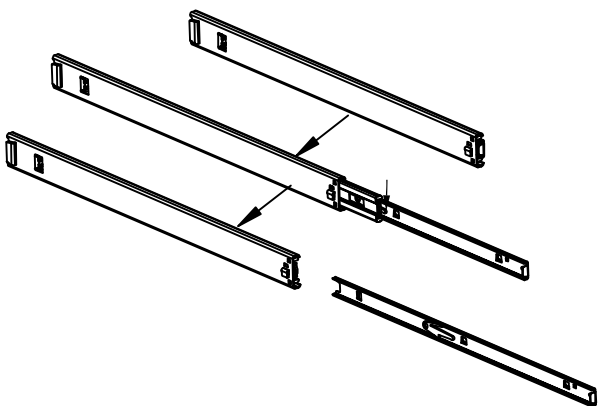

Right

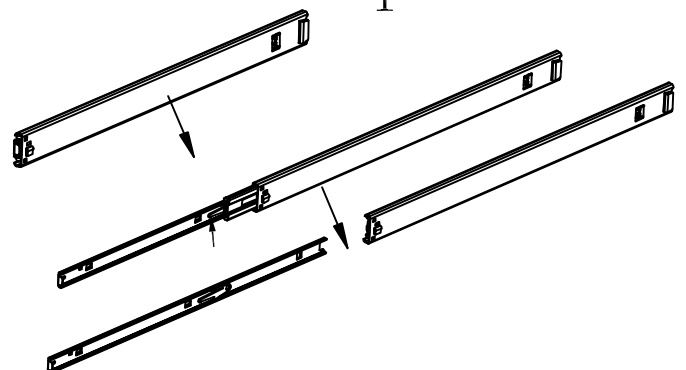

# First Step

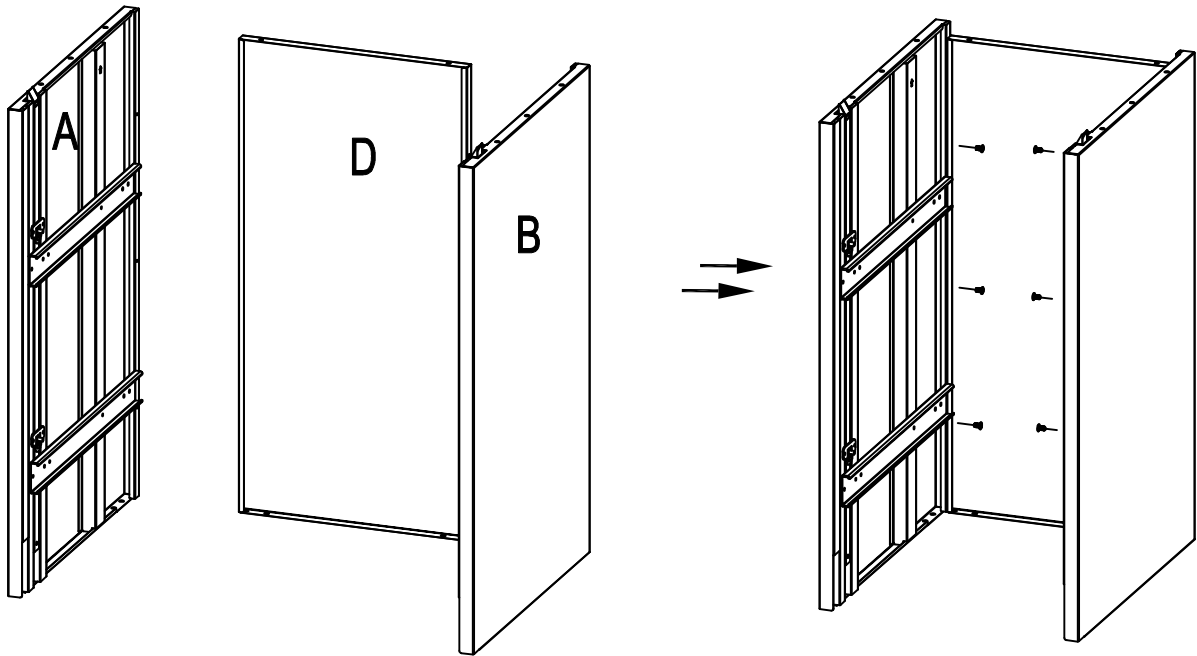

L

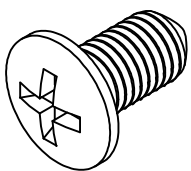

6PCS

## Second Step

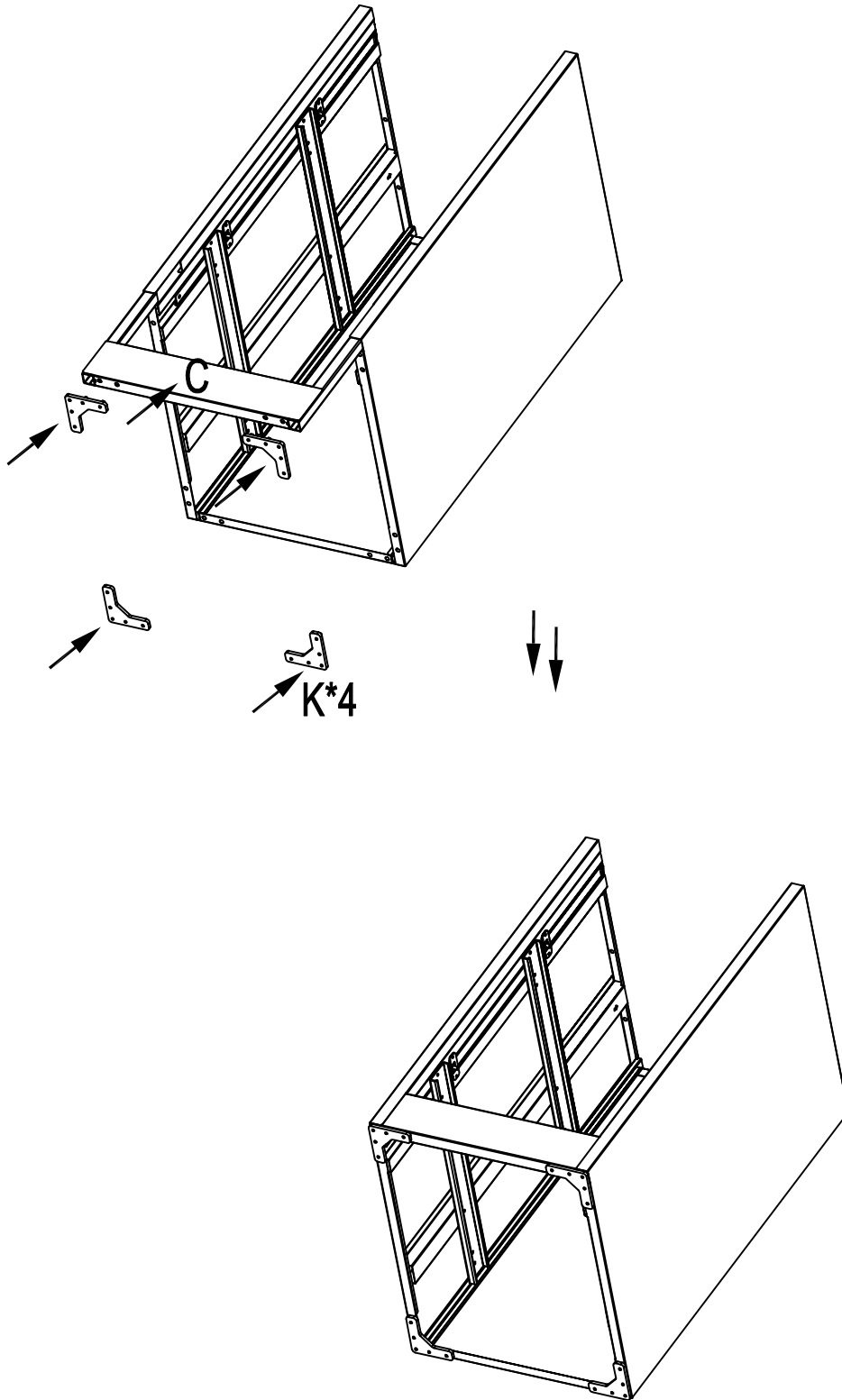

# Third Step

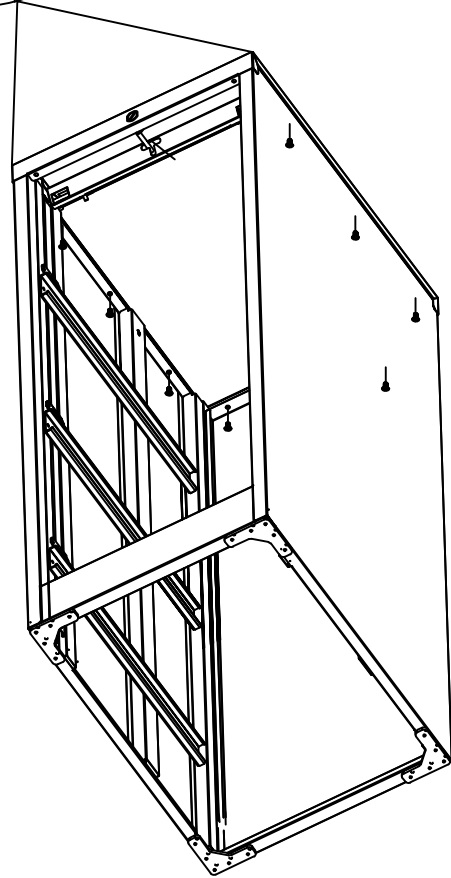
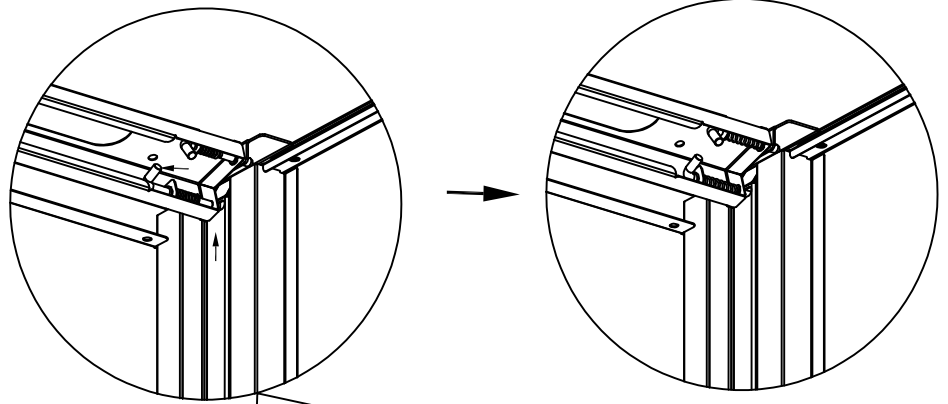
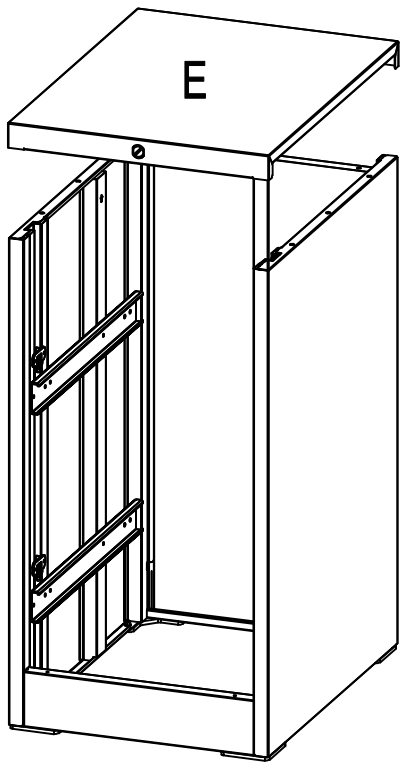

L

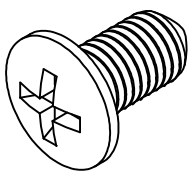

8PCS

# Fourth Step

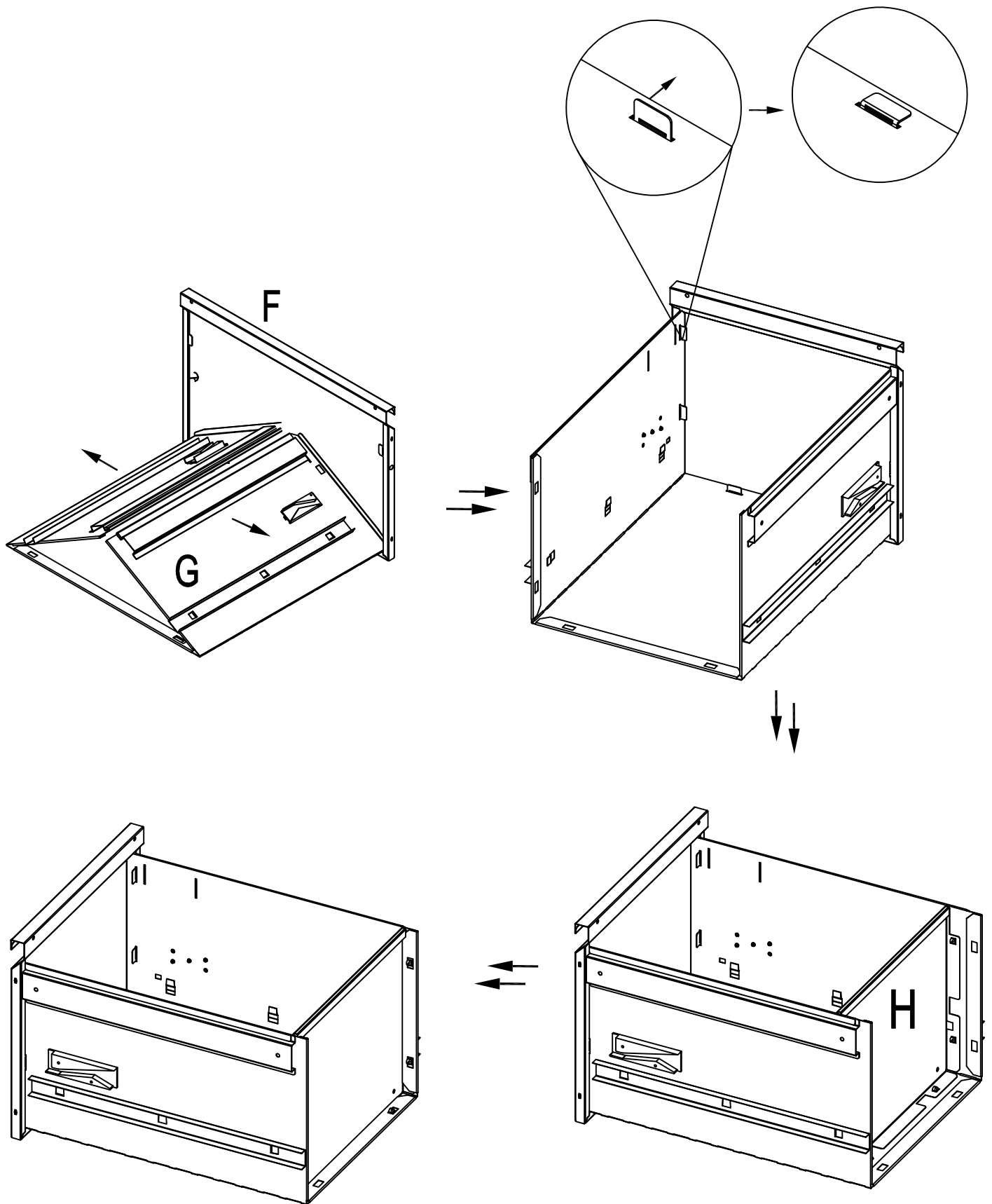

# Fifth Step

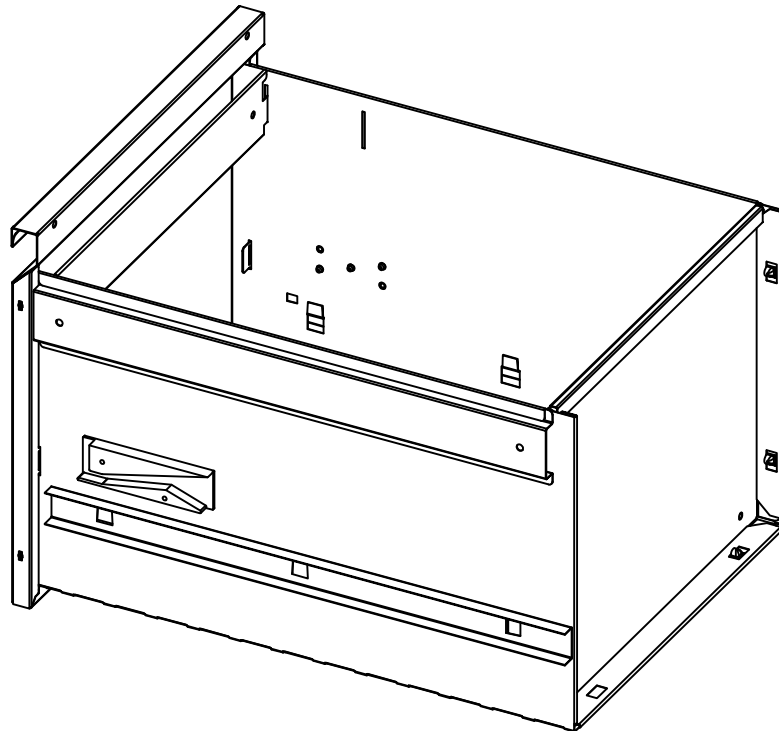
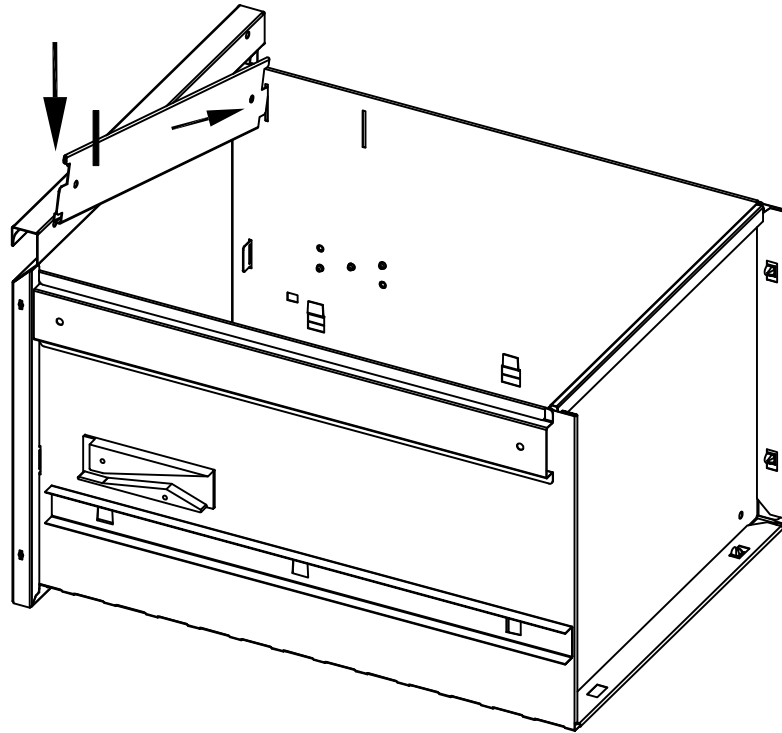



## Sixth Step

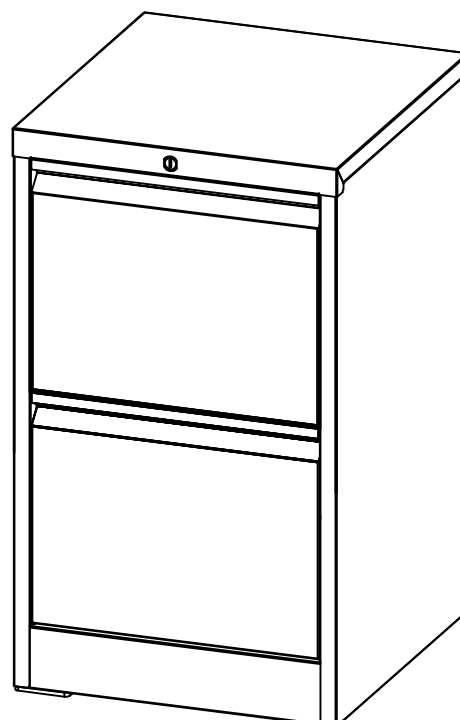
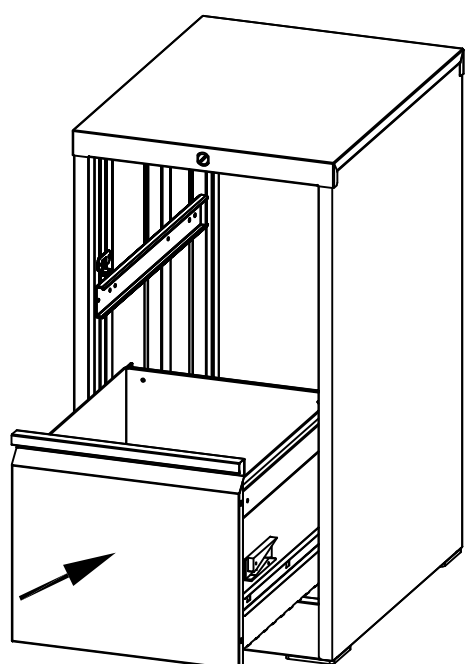

Must step: A First slide the steel ball to the front of the cabinet's outer slide.

B: Insert the inside railway course on both sides of drawer on the outside railway course of cabinet at the same time. Two people must put the drawer flat and insert it slowly and synchronously. After inserting it to the end, pull it out slowly twice, the slide track works normally. If it works fails, please follow the slide track removal instructions, open it and reinstall it.

