

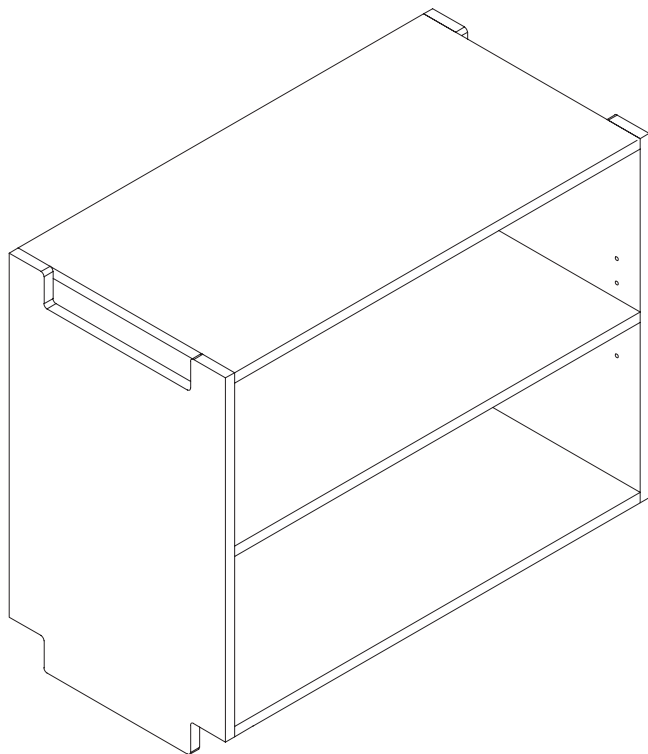

gltc.co.uk

Alba Regular - Adjustable Shelf Unit, White L4466



Assembly Difficulty



easy - medium - hard



one-person job



29/05/2019

Thank you for shopping with GLTC, we hope you enjoy having this product in your home.

We know assembling furniture, toys or accessories is not everyone's favourite way to spend their time, so we've tried to make assembling this item as quick and painless as possible.

Hopefully our efforts will have been worthwhile and you'll sail through the whole process. But if it all feels a bit too much like hard work, then we do have an assembly company we can recommend: the Flatpack Construction Company offers a nationwide service and can be contacted on **0843 289 4951** or **www.flatpackconstruction.co.uk**.

A few important pointers before you start:

- Please read the instructions right through before you start, and check that all the components have been included in the pack; we find separating all the hardware into piles makes it easier to be sure that everything is present and correct.
- Make sure you have the right tools. Allen keys are provided if required, but screw drivers and other tools are not. You'll find details of the tools you need at the beginning of the instructions.
- It's a good idea to build the unit in the room where you are going to be using it, to avoid the need to move it after it's been assembled.
- Do not throw away any packing materials until assembly is complete, just in case you accidentally discard smaller parts or hardware.

Safety Warnings:

- Please read these instructions carefully before assembly.
- Warning! Not suitable for children under 3 years due to small parts which may become detached and present a choking hazard.
- Assembly by a competent adult is required.
- Unassembled product contain small parts which may pose a choking hazard to young children.
- During assembly children should be kept away from the product due to possible risk of injury.
- Assemble and use on a flat and level surface.
- This product is heavy, we recommend that you build it where you are planning to use it.
- This unit must be used in conjunction with Alba Regular Base + Top Shelf unit. All stacked furniture combinations must start with a GLTC Alba base unit.
- It is recommended that the Alba range is only stacked 3 units high i.e. 1 x toy box base + top shelf & 2 x middle units.
- Do not use if any parts are missing or damaged as this may lead to products being unstable.
- DO NOT use power tools in the assembly of this product as there is a risk of over tightening and consequently splitting of the wood.
- Do not over tighten hardware. Cam dowels should be inserted to the collar. Back panel screws should be screwed until they naturally tighten/stop. This is difficult to feel if power tools are being used.
- WARNING! FURNITURE TIPPING RISK. Serious or fatal crushing injuries can occur from furniture tipping over. Ensure you secure this furniture product to the wall before you use it, using the kit provided. If you have not received an anti-tip kit with your product please contact Customer Services.

- To avoid possible injury from tipping - DO NOT allow children to step or climb on the product.
- Check all fixtures and fittings regularly and tighten as necessary.
- Remove all packaging before allowing your child to use the product.
- Please retain for future reference.

Customer Service:

- If you find that any components are missing or damaged, please do not begin assembly and do not use the item. Please contact GLTC Customer Services on **0344 848 6000** immediately.
- We do stock spare hardware packs at our warehouse, so we should be able to send you a replacement pack immediately if required.

Product Care:

- Wipe clean using a soft damp cloth followed by a dry cloth.
- Do NOT use cleaning products which contain ammonia, solvents or abrasive material.
- Do NOT expose the item to extremes of heat and humidity.
- Regularly check all fastenings, fixtures and fittings to ensure that they properly tightened.

Could we do better?



If there is anything you think could be improved in these instructions or in the assembly of this product we'd be grateful if you could let us know; we'll pass any helpful hints and tips on to other customers via our website and update the instructions.

All you need to do is drop us a line at instructions@gltc.co.uk

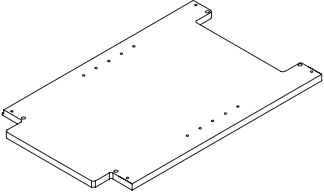
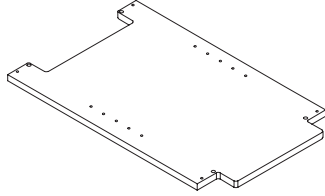
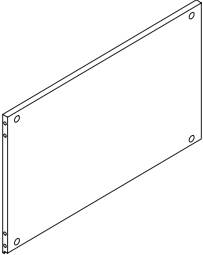
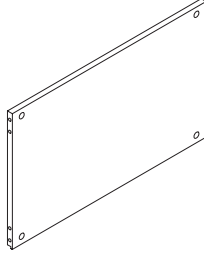
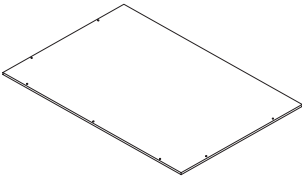
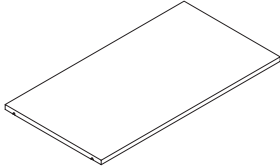
Component Check List

<p>A</p>  <p>1x RH Side Panel</p>	<p>B</p>  <p>1x LH Side Panel</p>
<p>C</p>  <p>1x Top Panel</p>	<p>D</p>  <p>1x Base Panel</p>
<p>E</p>  <p>2x Back Panels</p>	<p>F</p>  <p>1x Shelf Panel</p>

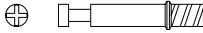
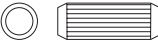
Component Check List

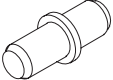
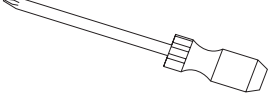
<p>#1</p>  <p>8x 35mmL Cam Dowels</p>	<p>#2</p>  <p>8x Wooden Dowels 25mmL</p>
<p>#3</p>  <p>8x 12mmL Cam Locks</p>	<p>#4</p>  <p>14x 14mmL Domed Head Screws</p>
<p>#5</p>  <p>4x Shelf Supports</p>	<p>#6</p> <p>You will need (not supplied)</p>  <p>Philips Head Screwdriver</p>

Hardware for Step 1:

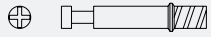

8x #1 Cam Dowels

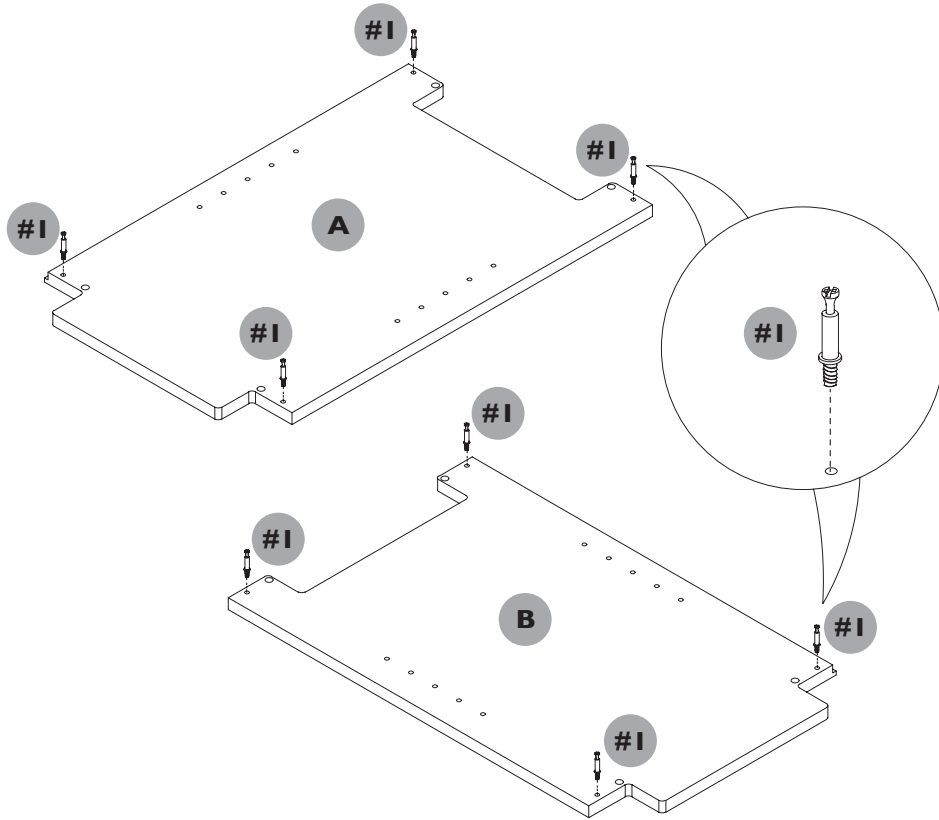

STEP 1:

Prepare the side panels.

Insert 4x cam dowels into the four holes on the corners of BOTH side panels A & B.

STEP 2:

Take Panel A and insert 4x wooden dowels (#2) into the holes at the edges of the panel as shown. Position with the grooved edge on the floor.

Connect top panel C and base panel D with the side panel.

Note the positioning of these panels.

- Ensure that the large drill holes on these panels are facing towards the BASE (the protruding end of the side panel.)
- The grooved edges should be on the floor.

Insert 2x cam locks (#3) into the large drill holes on BOTH panels C & D and turn clockwise to secure.

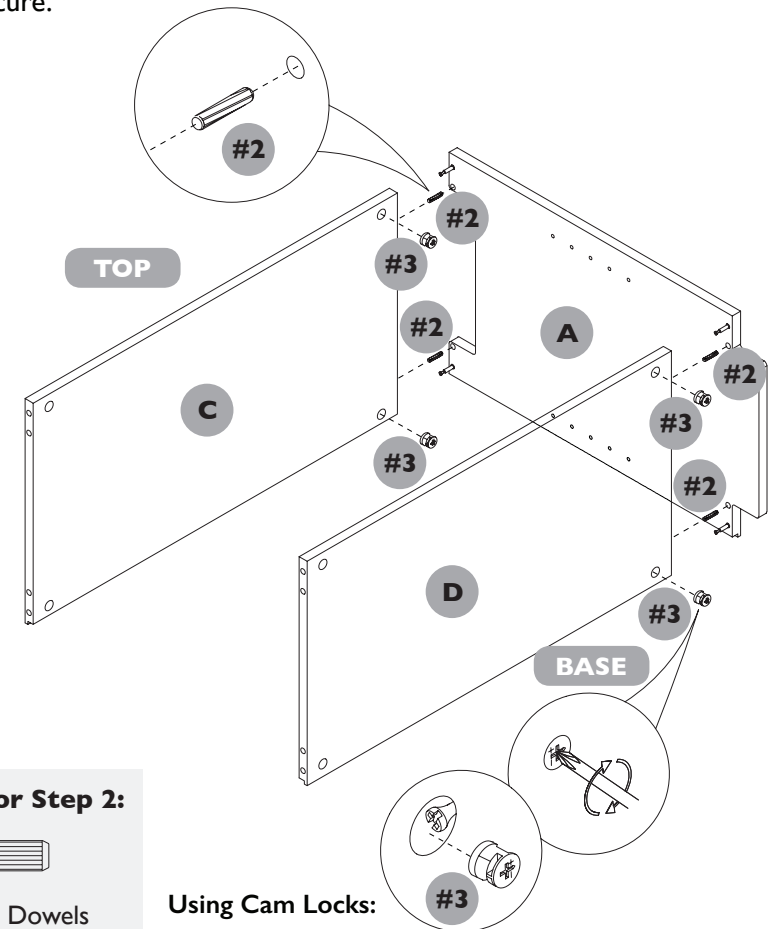

Hardware for Step 2:



4x #2 Wooden Dowels



4x #3 Cam Locks

Using Cam Locks:

When inserting into the panel, ensure that each cam lock's arrow is pointing towards the drill hole on the side edge of the panel & the dowel that it will be receiving. When the panels are in the connected position, using a screwdriver, turn the cam lock in a clockwise direction to lock and secure.

Hardware for Step 3:

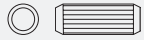

4x #2 Wooden Dowels



4x #3 Cam Locks

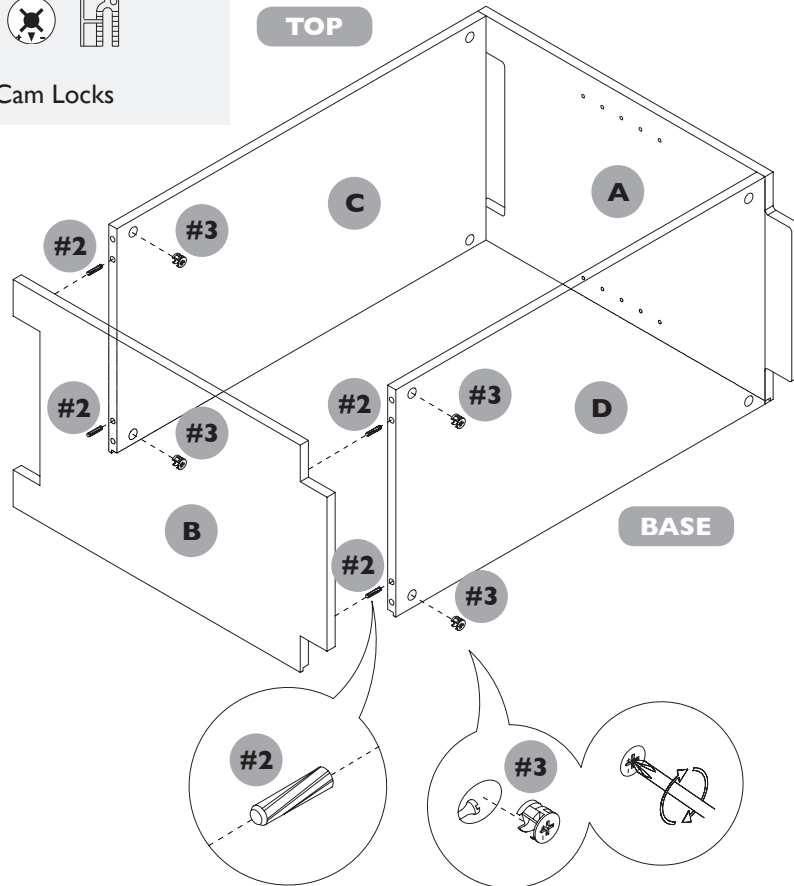

STEP 3:

Repeat step 2 to fix side panel B in position, again ensuring the panel is positioned with the grooved edge on the floor and the protruding end pointing in the same direction as the large drill holes on the underside of panels C & D (towards the base).

Ensure all cam locks are tightened fully.

Hardware for Step 4:



14x #4 Domed Head Screws

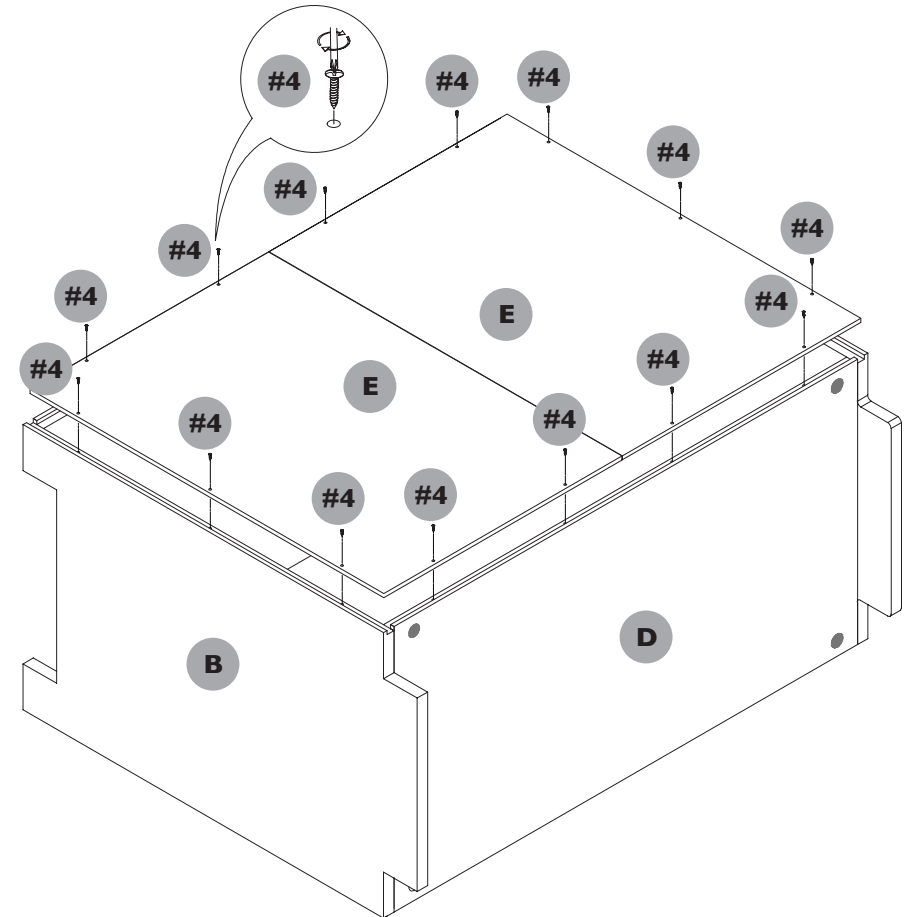

STEP 4:

Carefully turn unit over, please do this with a second person if necessary.

Place both back panels E on the unit and align with the pilot holes on the grooved back edges. Secure the panels in place with 14x domed head screws (#4).

STEP 5:

Stand the unit upright and insert the 4x shelf supports (#5) at the desired shelf level.

Insert shelf panel F.

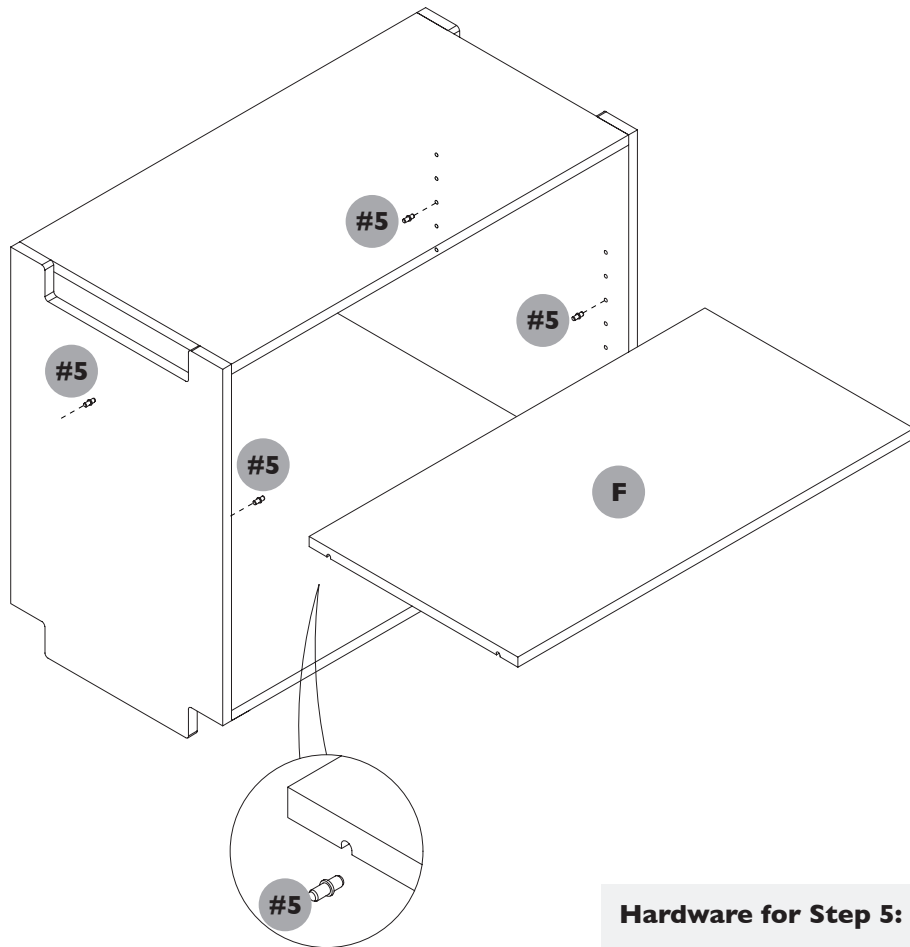

Hardware for Step 5:



4x #5 Shelf Supports

STEP 6:

Your unit is now ready to use.

This unit should NOT be used on it's own, it must be used with an appropriate Alba REGULAR base unit.

