

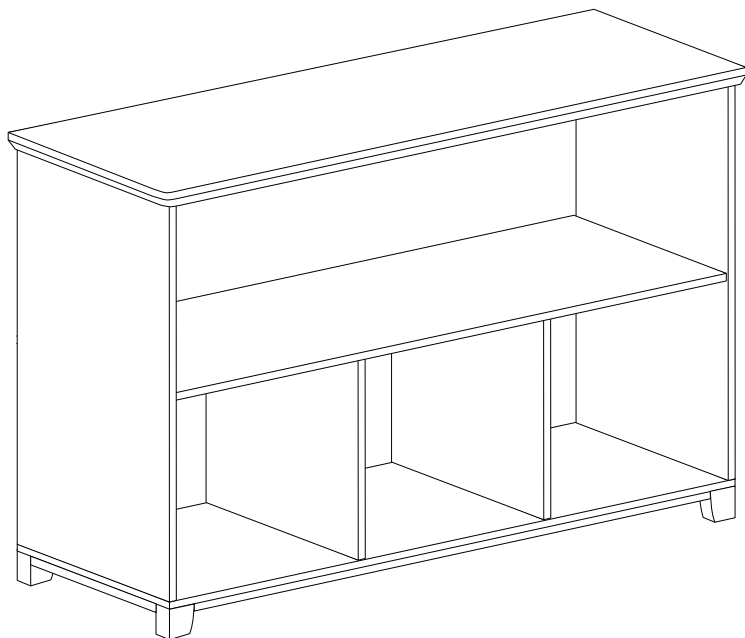

gltc.co.uk

Blake Cube Storage - Shelf Unit



Thank you for shopping with GLTC, we hope you enjoy having this product in your home.

We know assembling furniture, toys or accessories is not everyone's favourite way to spend their time, so we've tried to make assembling this item as quick and painless as possible.

Hopefully our efforts will have been worthwhile and you'll sail through the whole process. But if it all feels a bit too much like hard work, then we do have an assembly company we can recommend: the Flatpack Construction Company offers a nationwide service and can be contacted on **0843 289 4951** or **www.flatpackconstruction.co.uk**.

A few important pointers before you start:

- Please read the instructions right through before you start, and check that all the components have been included in the pack; we find separating all the hardware into piles makes it easier to be sure that everything is present and correct.
- Make sure you have the right tools. Allen keys are provided if required, but screw drivers and other tools are not. You'll find details of the tools you need at the beginning of the instructions.
- Do not throw away any packing materials until assembly is complete, just in case you accidentally discard smaller parts or hardware.

Assembly Difficulty



easy - medium - hard



two-person job



14/12/2020

Safety Warnings:

- PLEASE RETAIN THESE INSTRUCTIONS FOR FUTURE REFERENCE.
- Adult assembly required, assemble and use on a flat surface.
- CHOKING HAZARD – This product contains small parts and must be assembled by an adult. Special care should be taken in the unpacking and assembly of this item as unassembled parts may be a choking hazard to children under 3 years old.
- During assembly, children should be kept away from the product due to possible risk of injury.
- Do not use power tools in the construction of this product.
- Cam dowels are used in the assembly of this unit. There is a natural stopping point when inserting, do not over-tighten.
- This product is heavy, so we recommend that you build it where you are planning to use it.
- All assembly fastenings should be tightened properly and periodically checked; care should be taken that no fittings are loose.
- Do not let children climb this unit as it could tip and cause injury.
- Serious or fatal crushing injuries can occur from furniture tipping over. Ensure you secure this furniture product to the wall before you use it using the kit provided. If you have not received an anti-tip kit with your product please contact Customer Services.

Customer Service:

- If you find that any components are missing or damaged, please do not begin assembly and do not use the item. Please contact GLTC Customer Services on **0344 848 6000** immediately.
- We do stock spare hardware packs at our warehouse, so we should be able to send you a replacement pack immediately if required.

Product Care:

- Wipe clean using a soft damp cloth followed by a dry cloth.
- Do NOT use cleaning products which contain ammonia, solvents or abrasive material.
- Do NOT expose the item to extremes of heat and humidity.
- Regularly check all fastenings, fixtures and fittings to ensure that they properly tightened.





Could we do better?

If there is anything you think could be improved in these instructions or in the assembly of this product we'd be grateful if you could let us know; we'll pass any helpful hints and tips on to other customers via our website and update the instructions.



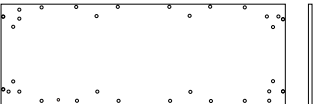
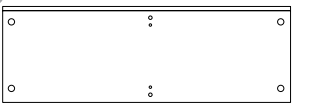
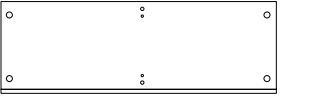
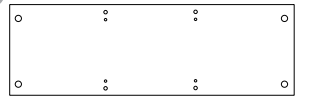
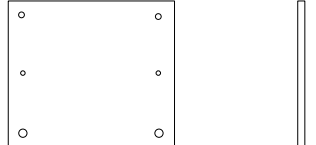

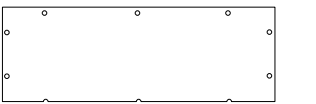
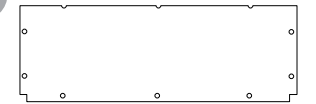
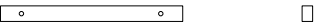



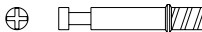

All you need to do is drop us a line at [**instructions@gltc.co.uk**](mailto:instructions@gltc.co.uk)

Thank you

Component Check List

<p>A</p>  <p>1x Base Panel</p>	<p>B</p>  <p>1x Side Panel</p>
<p>C</p>  <p>1x Side Panel</p>	<p>D</p>  <p>1x Shelf Panel</p>
<p>E</p>  <p>2x Vertical Dividers</p>	<p>F</p>  <p>1x Top Panel</p>
<p>G</p>  <p>1x Upper Back Panel</p>	<p>H</p>  <p>1x Lower Back Panel</p>
<p>I</p>  <p>2x Side Skirting Bars</p>	<p>J</p>  <p>2x Long Skirting Bars</p>
<p>K</p>  <p>4x Feet</p>	

Hardware Check List

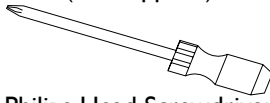
<p>#1</p>  <p>12x Cam Dowels 36mmL</p>	<p>#2</p>  <p>24x Wooden Dowels 20mmL</p>
<p>#3</p>  <p>12x Cam Locks 15mm dia</p>	<p>#4</p>  <p>8x Barrel Nuts 10mm dia</p>
<p>#5</p>  <p>4x Hex Bolts 42mmL</p>	<p>#6</p>  <p>15x Wood Screws 16mmL</p>
<p>#7</p>  <p>4x Wooden Dowels 25mmL</p>	<p>#8</p>  <p>8x Cross-Head Bolts 47mmL</p>
<p>#9</p>  <p>12x Wood Screws 25mmL</p>	<p>#10</p>  <p>1x Allen key</p>
<p>#11</p>  <p>1x Anti-tip Kit</p>	<p>You will need (not supplied)</p>  <p>Philips Head Screwdriver</p>

Hardware for Step 1:

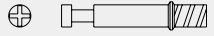

4x #1 Cam Dowels



4x #2 Wooden Dowels (20mm)

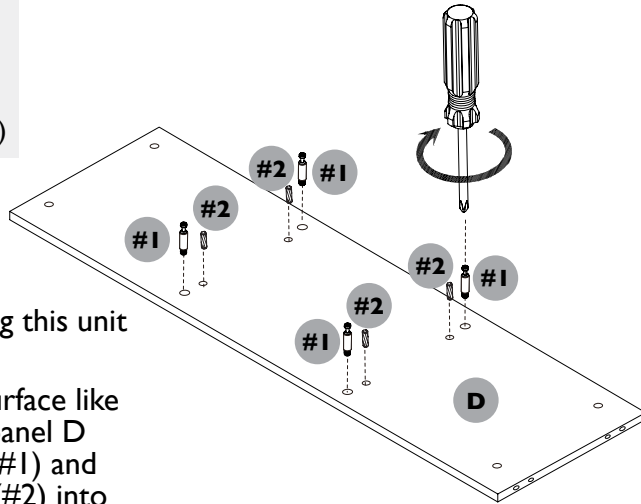

STEP 1:

Please note, you are building this unit with the back on the floor.

Working on a protective surface like a carpet or rug, take shelf panel D and insert 4x cam dowels (#1) and 4x 20mm wooden dowels (#2) into the panel as shown.

STEP 2:

Position Panel D with the small drill holes on the long edge on the floor.

Align the hardware on panel D with the holes on the edges of both panels E and connect to the unit as shown. When in place, insert 2x cam locks (#3) into the large drill holes of BOTH the divider panels E and turn clockwise to secure.

Using Cam Locks:

When inserting into the panel, ensure that each cam lock's arrow is pointing towards the drill hole on the side edge of the panel & the dowel that it will be receiving.

When the panels are in the connected position, using a screwdriver, turn the cam lock in a clockwise direction to lock and secure.

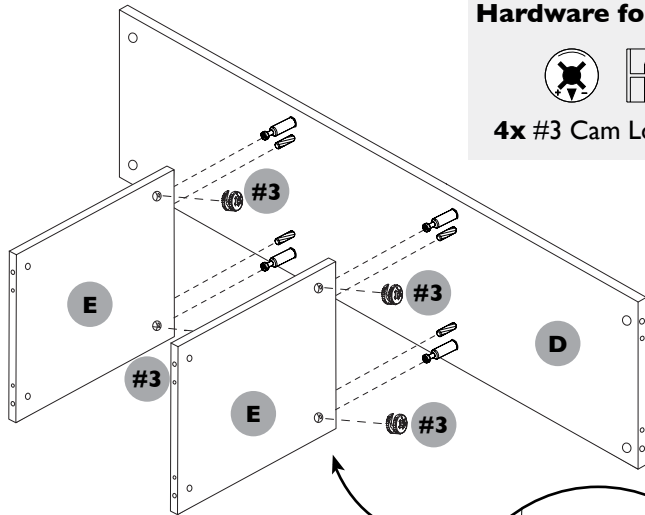

Hardware for Step 2:



4x #3 Cam Locks

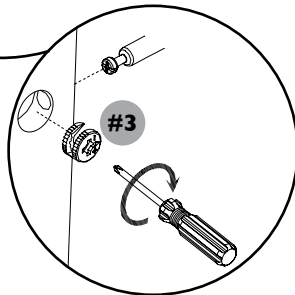

Hardware for Step 3:

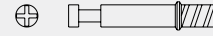

4x #1 Cam Dowels



4x #2 Wooden Dowels (20mm)

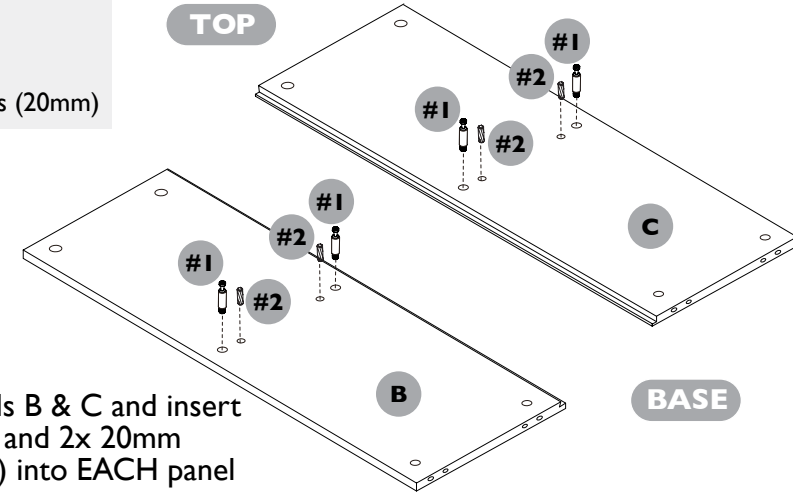

STEP 3:

Take both side panels B & C and insert 2x cam dowels (#1) and 2x 20mm wooden dowels (#2) into EACH panel as shown.

STEP 4:

Take side panel B and orientate so that the grooved edge is facing down, the smaller drill holes are at the base and the larger drill holes are at the top of the panel.

Hardware for Step 4:



2x #3 Cam Locks

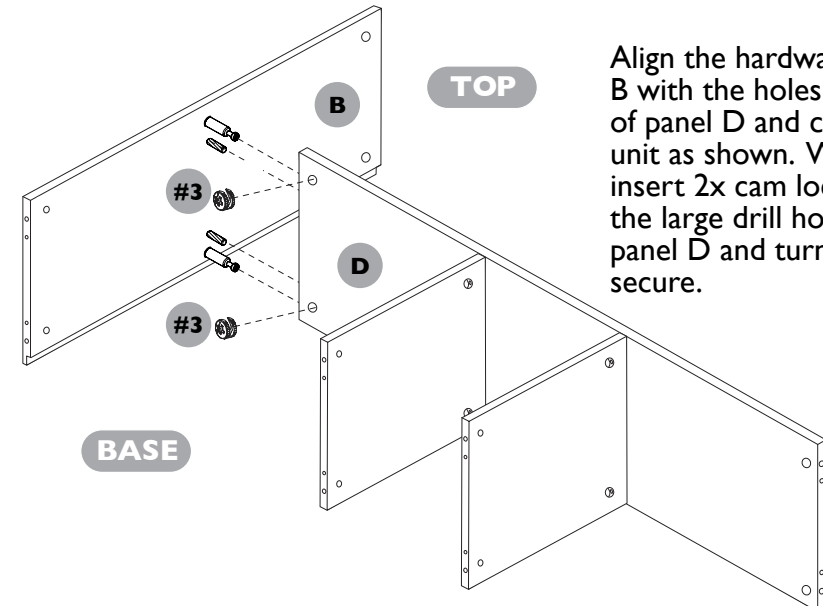

Align the hardware on panel B with the holes on the edge of panel D and connect to the unit as shown. When in place, insert 2x cam locks (#3) into the large drill holes on shelf panel D and turn clockwise to secure.

STEP 5:

Take side panel C and orientate so that the grooved edge is facing down, the smaller drill holes are at the base and the larger drill holes are at the top of the panel.

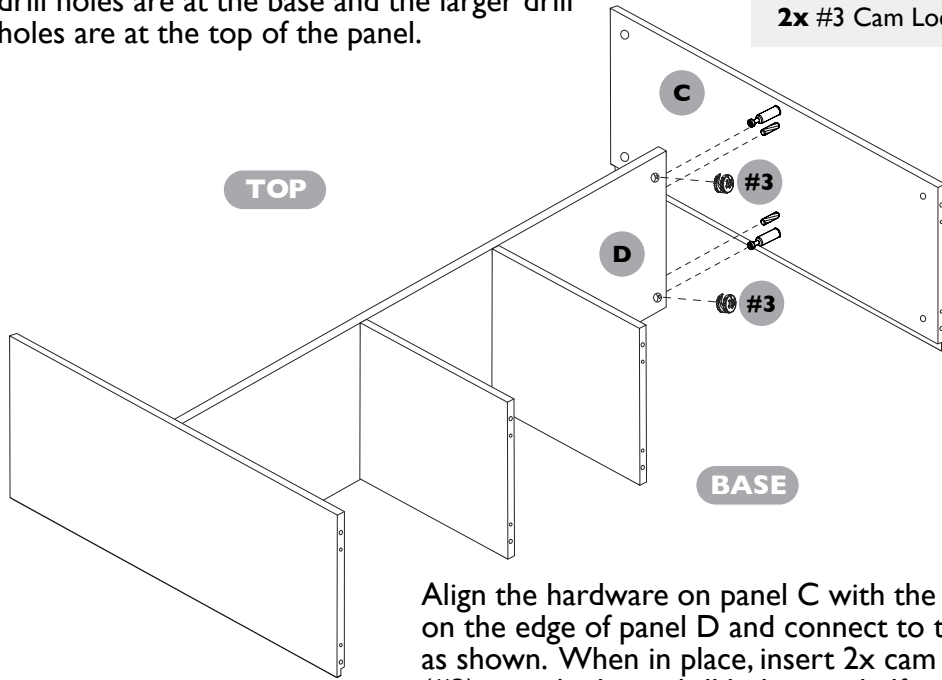

Hardware for Step 5:



2x #3 Cam Locks

Align the hardware on panel C with the holes on the edge of panel D and connect to the unit as shown. When in place, insert 2x cam locks (#3) into the large drill holes on shelf panel D and turn clockwise to secure.

STEP 7:

You are joining top panel F at the side of the unit that has the larger drill holes on panels B & C.

Orientate top panel F with the grooved edge facing down and align all the hardware with the corresponding holes on panels B & C.

When in place, insert 4x cam locks (#3) into the large drill holes on the vertical panels and turn clockwise to secure.

Hardware for Step 7:



4x #3 Cam Locks

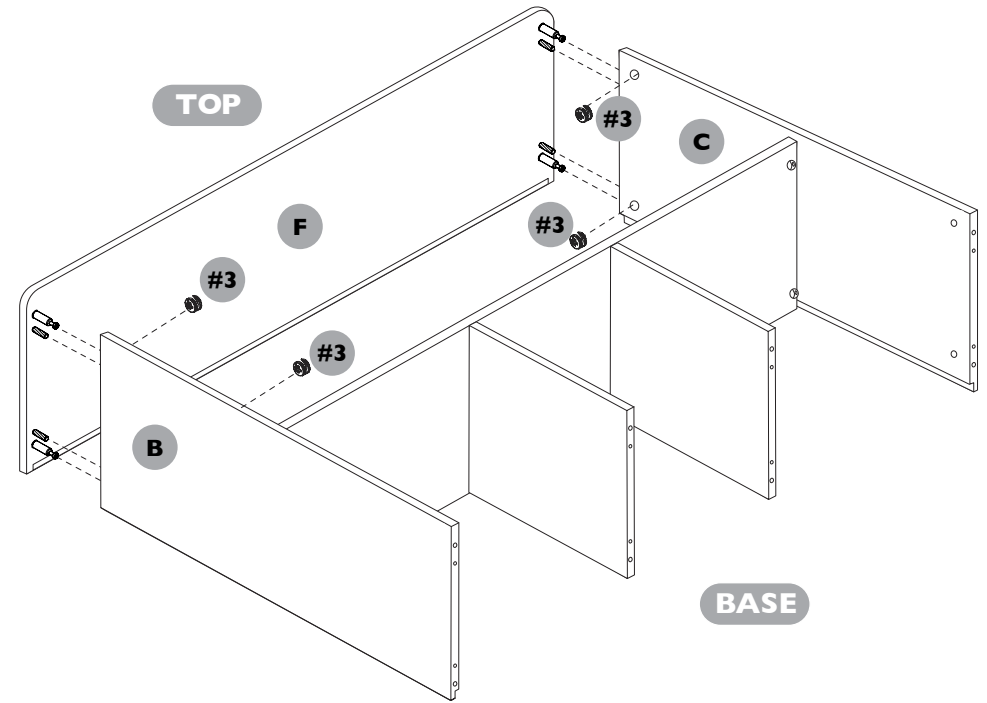

Hardware for Step 6:

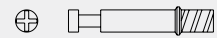

4x #1 Cam Dowels



4x #2 Wooden Dowels (20mm)

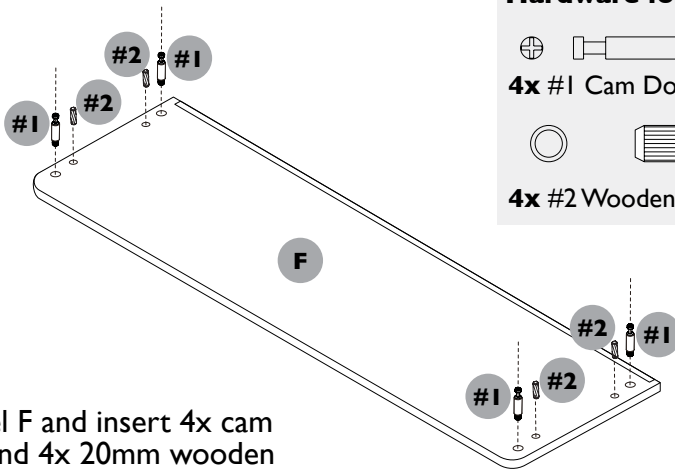

STEP 6:

Take top panel F and insert 4x cam dowels (#1) and 4x 20mm wooden dowels (#2) into the panel as shown.

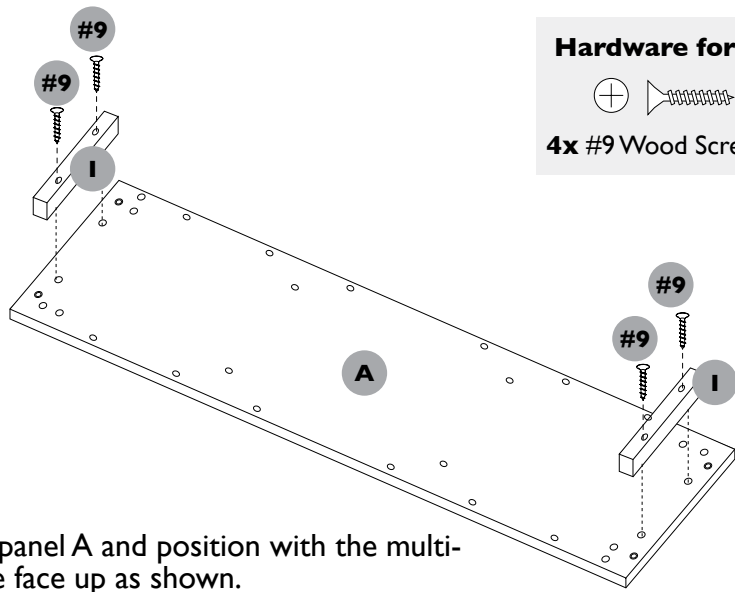

Hardware for Step 8:



4x #9 Wood Screws (25mm)

STEP 8:

Take base panel A and position with the multi-drilled side face up as shown.

Attach the 2x side skirting bars (I) to panel A using 4x 25mm wood screws (#9) in the position shown. The recessed holes on the bars should be facing up.

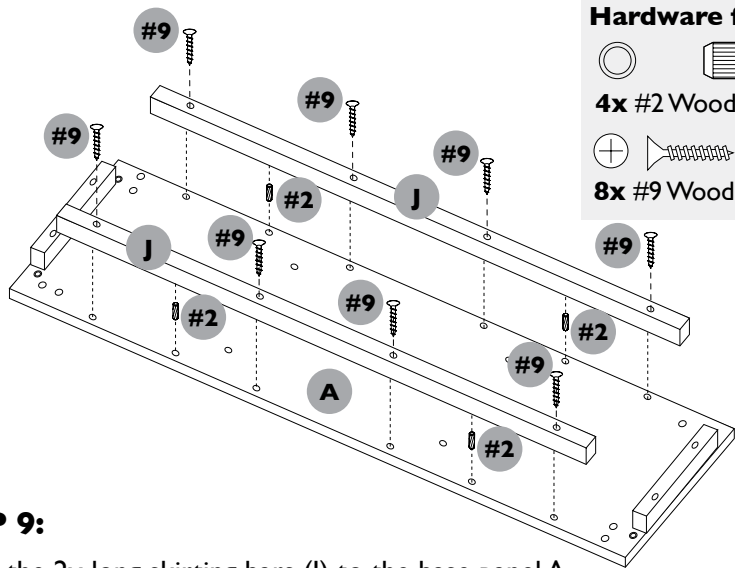

Hardware for Step 9:



4x #2 Wooden Dowels (20mm)



8x #9 Wood Screws (25mm)

STEP 9:

Attach the 2x long skirting bars (J) to the base panel A.

Position the bars along the edges of the base using 2x 20mm wooden dowels (#2) for EACH bar, then fix in place using 4x 25mm wood screws (#9) for EACH bar. Tighten fully. The recessed holes on the bars should be facing up.

Hardware for Step 10:



8x #2 Wooden Dowels (20mm)



8x #8 Cross-Head Bolts (47mm)



8x #4 Barrel Nuts

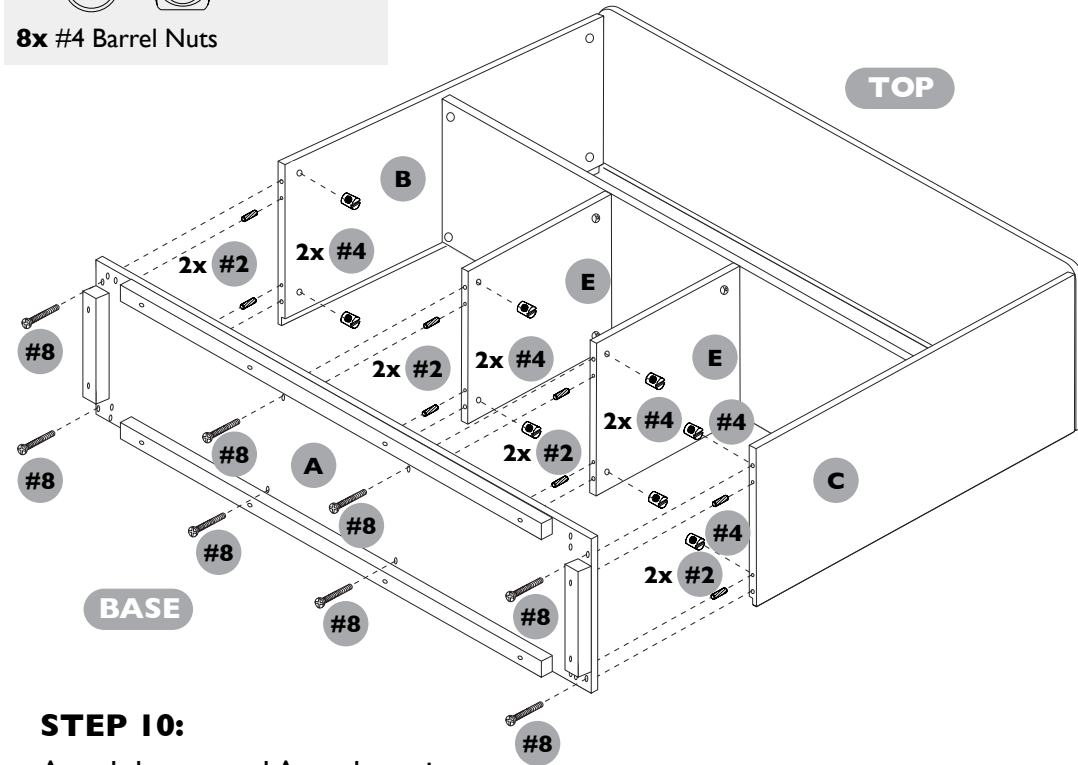

STEP 10:

Attach base panel A to the unit.

Start by inserting 8x 20mm wooden dowels (#2) into the two inner holes of the open edges of panels B, C and 2x E.

Now insert 8x barrel nuts (#4) into the holes on the sides of panels B, C and 2x E. Ensure the holes in the nut are pointing towards the edge where the base panel is joining.

With the grooved edge of the base panel at the back, align base panel A with the wooden dowels on the built unit and push into place.

Now insert 8x cross-head bolts (#8) into the holes as shown. Fully tighten to secure the base.

STEP 11:

Attach the 4x feet (K) to the base panel A.

Each foot uses 1x 25mm wooden dowel (#7) to position it and is then fixed in place with 1x hex bolt (#5).

Fully tighten the bolts using the allen key provided and repeat for all 4 feet.

Hardware for Step 11:



4x #7 Wooden Dowels (25mm)



4x #5 Hex Bolt (42mm)



1x #10 Allen Key

STEP 12:

Align and attach the back panels G & H using 15x back panel screws (#6).

Ensure the panels are positioned in the order shown below.

Please note that the 2x pilot holes indicated at the top of the side of the unit are to attach anti-tip straps included separately with this item. Please see next step.

Hardware for Step 12:



15x #6 16mmL Screws

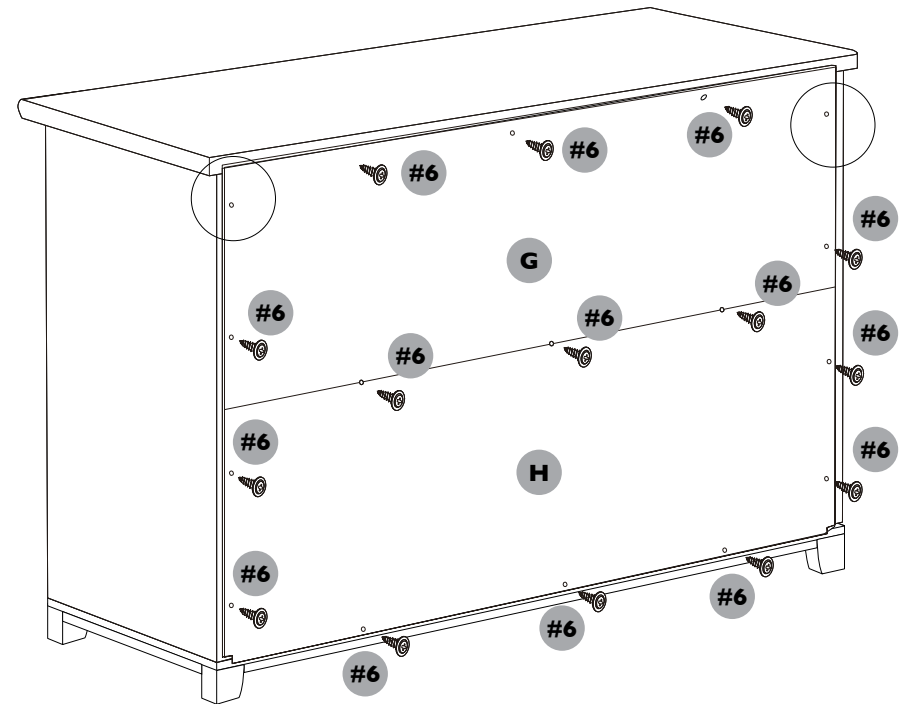
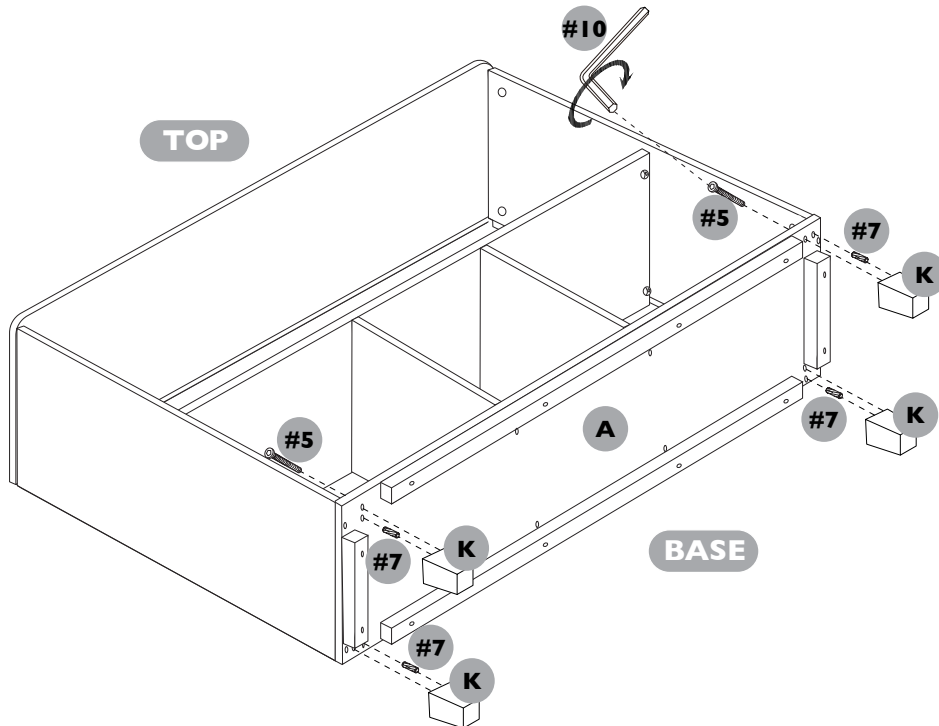

STEP 13:

Finally, open the anti tip kit included with your unit and attach 2 of the brackets to the unit using the screws in the kit in the position shown.

Your unit is now ready to be attached to the wall using hardware suitable for the wall type in your home (not provided). Please see kit instructions for details.

Hardware for Step 13:



1x #11 Anti-tip Kit

