

スリムレトロワークデスク 組立説明書

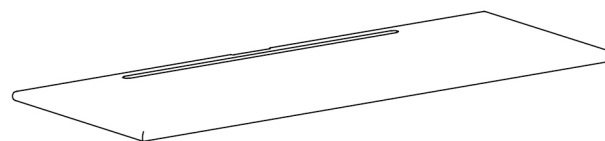

①天板*1

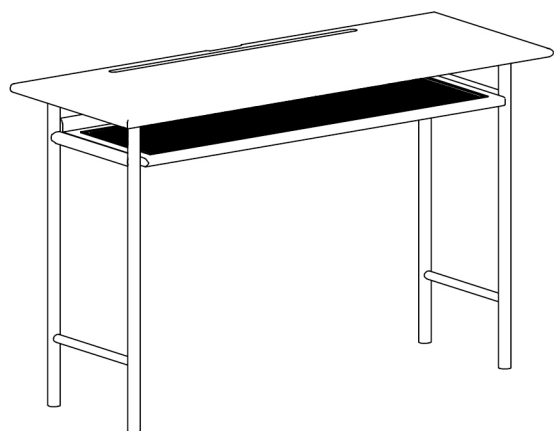
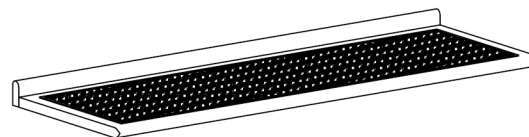

②棚板*1

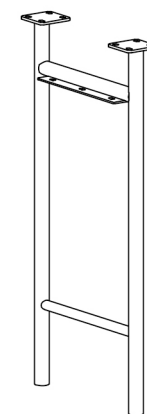

③ステンレス脚フレーム*2

CAGUUU

\ Follow me /

お友達追加・フォローをお願いします!
各SNSにて商品やクーポン情報を配信中です。





LINE



Instagram

☆レビューも書いていただくと、大変励みになります☆

A		Ø6mmX16mm	22
B		Ø8mmX18mmX1.2mm	22
C		M4mX57mm	1

製品の組立:

組立難易度: ★★

推奨組立人数: 2人

所要時間: 15分

1

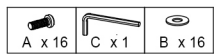

ステンレス脚フレームを固定

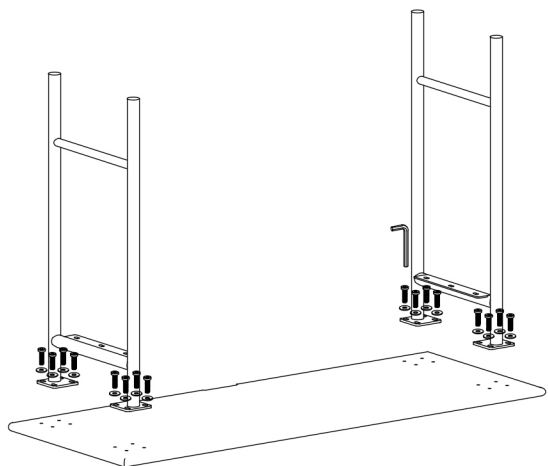

2

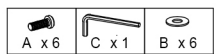

棚板の固定

