

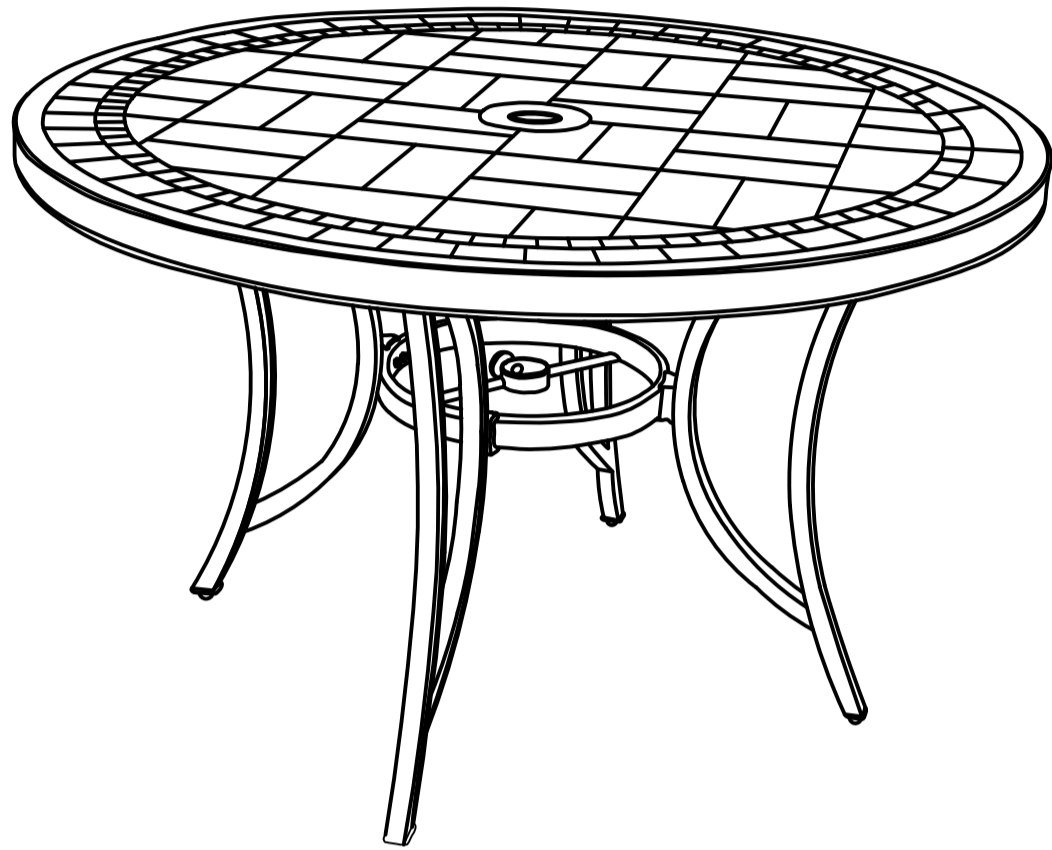

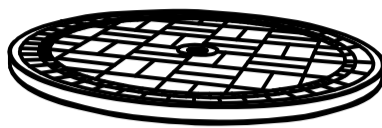







21OD112055FF

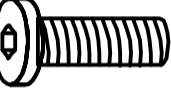

<b>A</b>		<b>F</b>		$\phi 6.5 \times 1.6$	x4
<b>B</b>		<b>G</b>		$\phi 6.5 \times 1.0$	x12
<b>C</b>		<b>H</b>		SZ043	x4
<b>D</b>		<b>I</b>		SZ092	x8
<b>E</b>		<b>J</b>		F1994	x1
		<b>K</b>		F1997	x1
					x8

1

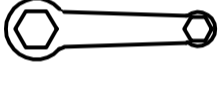
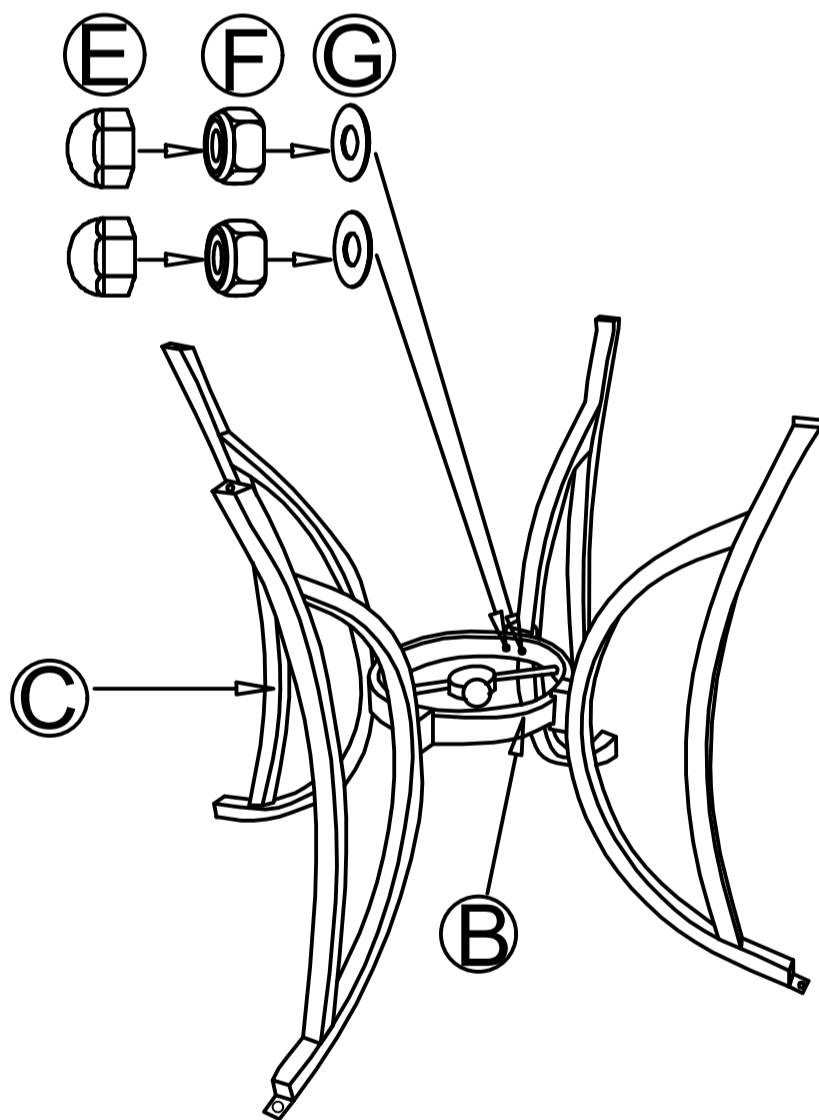

2

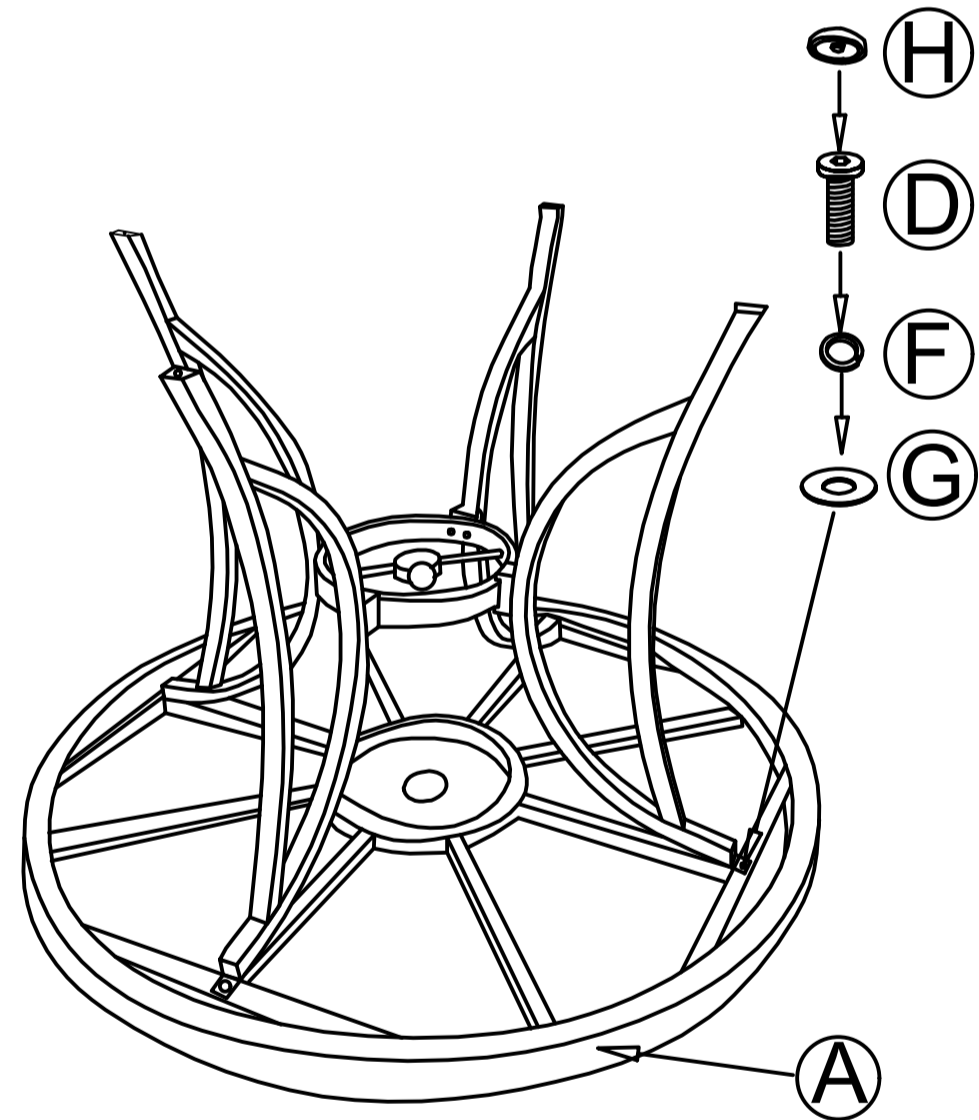

NOTE: Fix all the bolts in place, without tightening them first. After confirming the position of all the bolts, tighten the bolts and nuts. Each bolt must be tighten 3~4 revolutions only at a time and then move to another bolt until completely tighten, **DO NOT TIGHTEN COMPLETELY** one bolt first and then try to fix another bolt, as this operation will lead the other bolt hole to misalign.

NOTE : Fixez tous les boulons en place, sans les serrer au préalable. Après en confirmant la position de tous les boulons, serrez les boulons et les écrous. Chaque Le boulon doit être serré de 3~4 tours à la fois, puis passer à un autre boulon jusqu'à ce qu'il soit complètement serré, **NE PAS SERRER COMPLÈTEMENT** d'abord un boulon et ensuite essayer de fixer un autre boulon, car cette opération conduira le l'autre trou de boulon de se désaligner.