

THERMOSTATIC SHOWER Series INSTALLATION GUIDE



Model: 6001

Model: 6371

◆ INSTALLATION CONDITION



1. Refer to the 《Standard Part List》 when unpacking , check all parts available .

2. Do not disassemble mixer body by yourself.

3. Connect inlet hoses to supply valves.

4. Make sure inlet pipes and supply valves have been installed and cleaned, also ensure no impurities in pipeline.

5. After installation , check all joints for leakages.

6. Suggest don't fit the faucet in the severely corrosive environments.

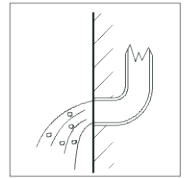
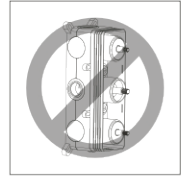

YOU MAY NEED:

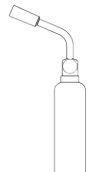
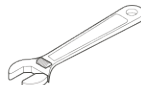
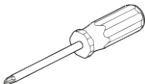

◆ **MODEL:6001**
PRODUCT LIST

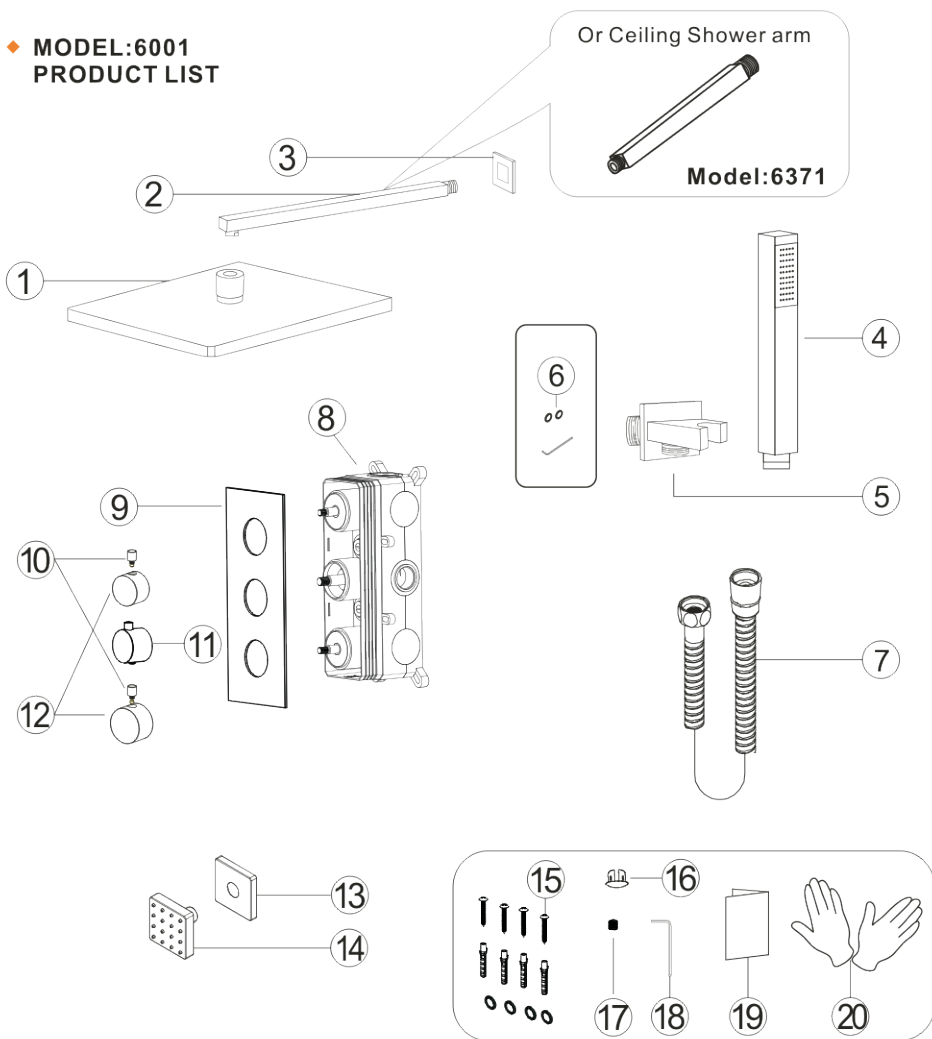

No.	Part name	Qty	No.	Part name	Qty
1	Shower head	1	11	Handle	1
2	Shower arm	1	12	Water diverter	2
3	Shower arm cup	1	13	Body jet cup	6
4	Shower hand	1	14	Body jet	6
5	Hand shower holder	1	15	Main body spare parts	4
6	Holder parts	1	16	Handle cup	1
7	Shower hose	1	17	Screw	3
8	Main body	1	18	Wrench	1
9	Panel	1	19	Instruction manual	1
10	Water diverter rod	2	20	Gloves	2

◆ **INSTALLATION SHOWER SET SIZE & WATER PIPE LINE REFERENCE**

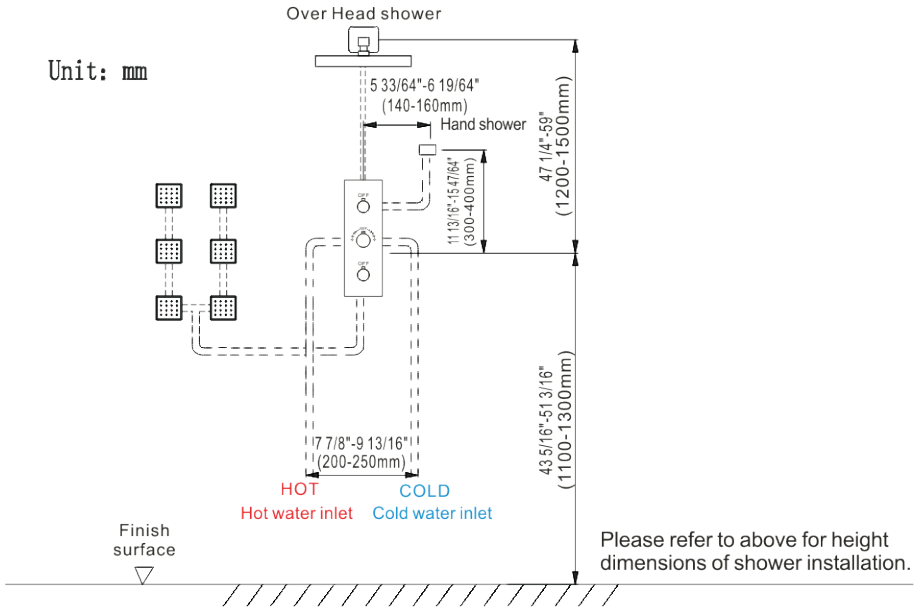

◆ **INSTALLATION DEPTH OF SHOWER ARM & SHOWER HOLDER & BODY JET**

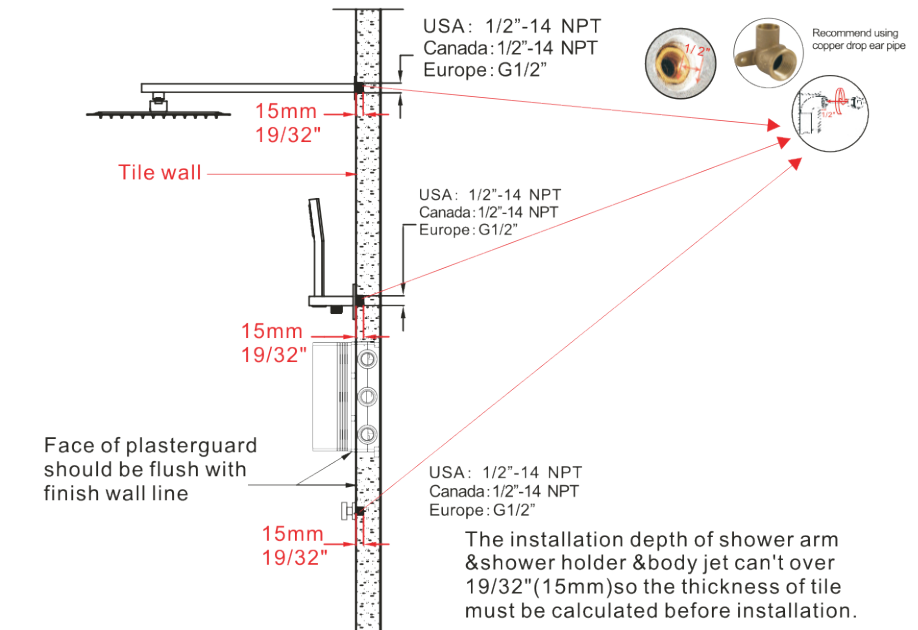

◆ **INSTALLATION DEPTH OF MAIN BODY**

Unit: mm/inch

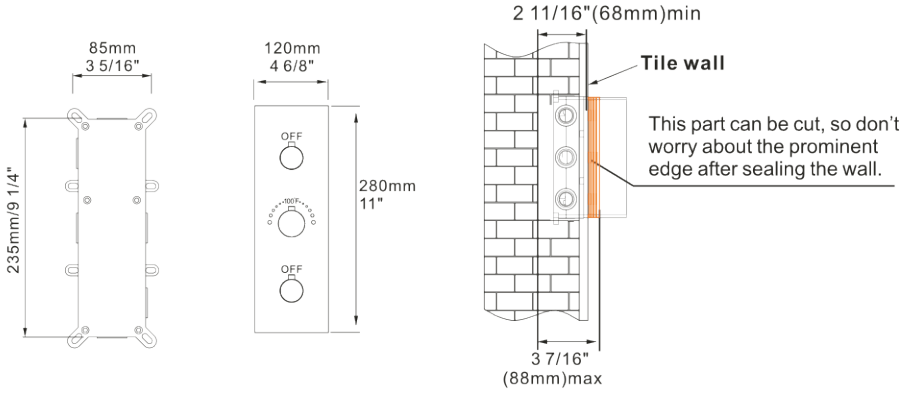

Notice: The installation depth of main body should be no less than 2 11/16"(68mm) and no more than 3 7/16"(88mm), including the thickness of tile, Otherwise, the panel cannot be installed.

◆ MAIN BODY CONNECTING PIPE SCHEMATIC DIAGRAM



Warning: must install hot water and cold water inlet strictly as instructions.

Wrap enough teflon tape

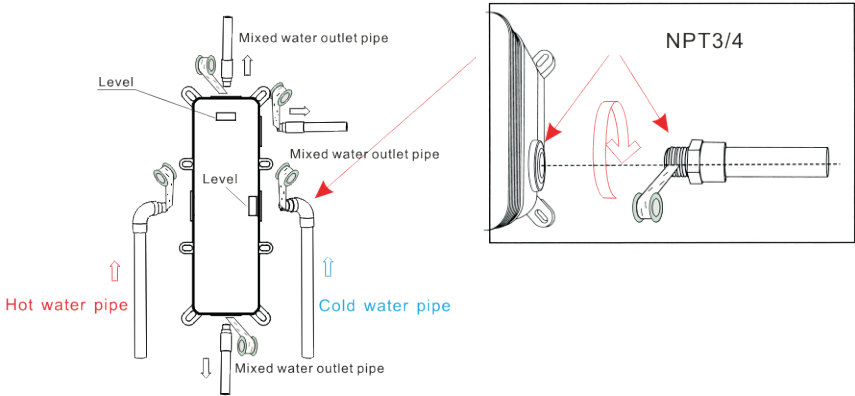

1. As shown in the figure, the inlet and outlet pipes are pre-buried, pay attention to the correct direction of installing the pre-buried main body, and make sure that the mark level on the top of the installation box is facing upward.
2. Install the hot and cold water inlet pipes, Shower head and hand shower holder body jet pipes. Turn on the water source to test whether the left and right inlet pipes are tightly connected without leakage. After the test, adjust the flow switch to be on to test whether the mixed outlet pipe. The connection is tight and there is no leakage.

◆ MAIN BODY VALVE INSTALLATION

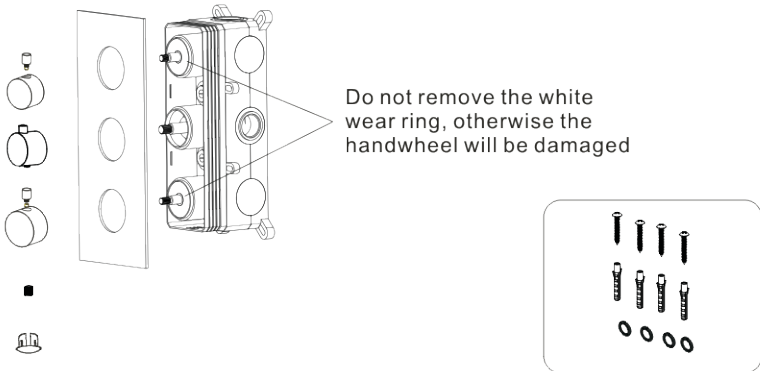

Use Valve gasket spare parts and to fixed Main body on the wall and then install Panel, Then use 3 pcs screws respectively to install 1pcs hand and 2 pcs water separation, and finally install the hand cover.

◆ INSTALLATION OF MASSAGE SHOWER

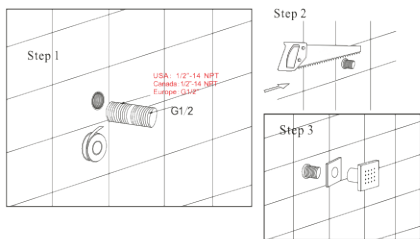

- Step 1. Wrap the threaded pipe of NPT1/2 with Teflon tape and screw it into the wall.
- Step 2. Cut off excess part with a saw.
- Step 3. Put on the decoration cap, then screw the massage shower in.

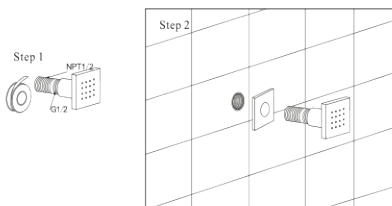

◆ SHOWER HOLDER INSTALLATION INSTALL THE HAND SHOWER HOLDER

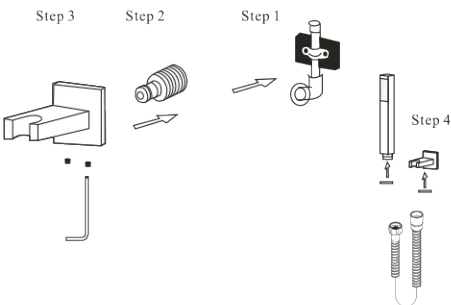

- Step 1. Screw the thread into the water pipe inside the wall.
- Step 2. Screw the hand shower holder with cover into the thread.
- Step 3. Rotate and fix the body with the special-shaped wrench.
- Step 4. Connect hand shower and the hose.

◆ INSTALLATION OF RAIN SHOWER HEAD & SHOWER ARM

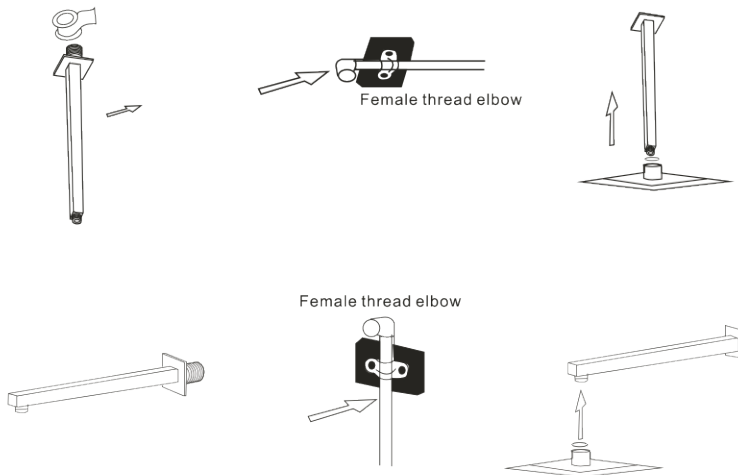

Connect top outlet to shower arm with proper fittings. To prevent damage, to finish on shower arm, insert wall end of shower arm into shower flange before screwing arm into riser connection. Thread showerhead onto shower arm. Apply tape to pipe threads on both ends. Do not overtighten showerhead. The showerhead is 360 swivel connection.

◆ CARE AND MAINTENANCE

In order to keep the mixer surface bright , please clean the mixer regularly.

Rinse faucet with clean water and wipe with soft cotton cloth.

Avoid using cleaning powder , harsh cleaning chemicals, brushes, and cloth with coarse surface to prevent scratching and corrosion.

Do not use acid cleaner to clean the faucet as it may cause surface corrosion of the faucet. If the faucet comes into contact with harmful acid substances, please rinse it with water immediately.



◆ IF A LARGE-SCALE CLEAN-UP IS NECESSARY, FOLLOW THESE PROCEDURES

1: Use clean water and soft cloth to remove dirt on the surface as much as possible.

2: Use one of the following cleaners to remove dirt on the surface

Mild liquid cleaner.

Colorless glass cleaner, powder cleaner which does not have abrasive function and can be dissolved completely.

Polish liquid which does not have abrasive function.

3: After cleaning, remove the cleansing agent with clean water completely and wipe with soft cotton cloth.