

# CARTRIDGE

- Pressure Balance cartridge



# STANDARDS

- Third party certified to meet ASME A112.18.1 all applicable requirements referenced therein

## Important

### IMPORTANT

1. Please check that all components are present.
2. Before installation ensure that all feed lines are clear of debris and on/off valve is present.
3. Ensure water pressure is between 20-125 PSI (includes combination of hot and cold feed lines).
4. Pictures in the manual are general in content and may not represent exactly your purchased faucet. If you are having difficulties please contact a professional plumber.
5. If you will be away from home for an extended period you should shut off the main water supply.
6. Please insure that to make a wash for all water pipe before installation to insure no impurity inside.
7. When you need to welding the shower valve to the water pipe of the valve, please remember to take out the cartridge and any seal parts of the valve. When finish welding, need to wait for body of the valve cool down and then install the cartridge and the seal parts.
8. Need to used the 11-13N.m power to lock the cartridge.

All valve have the pass the the air testing and pressure testing before ship out. If request presssure testing before installation, Must under the guide of the professional Plumber with license. And air pressure do not over 125PSI. If you want to the Brust testing over 50±2PSI, you need to changed a new cartridge for normal using.



MONDAWE  
PICK YOUR FAVORITE

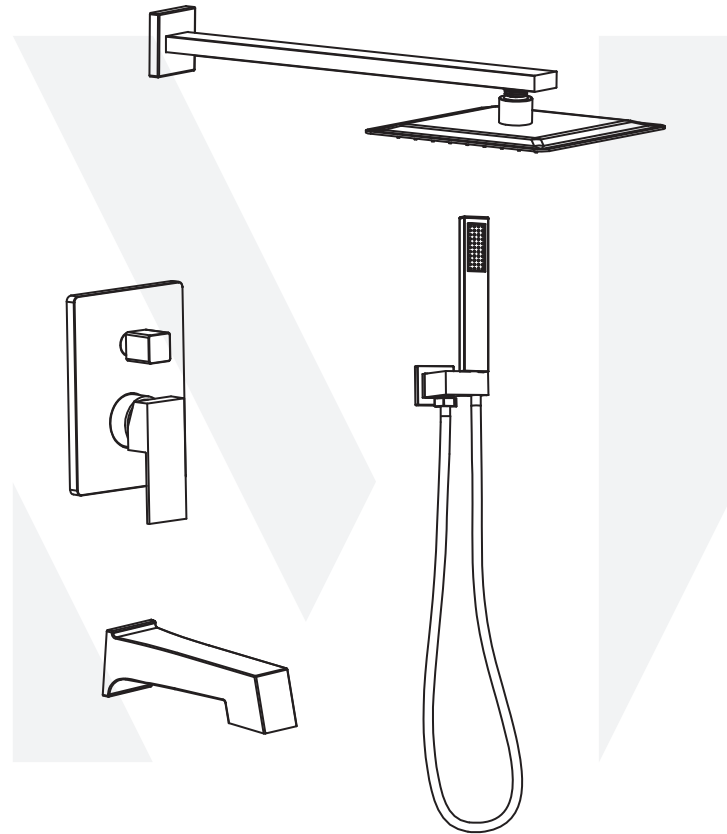

TEL:(720)805-3223

Get More Help by sending emails at [service@mondawe.com](mailto:service@mondawe.com)

You can also view more products at <https://mondawe.com/>

## Technical drawing

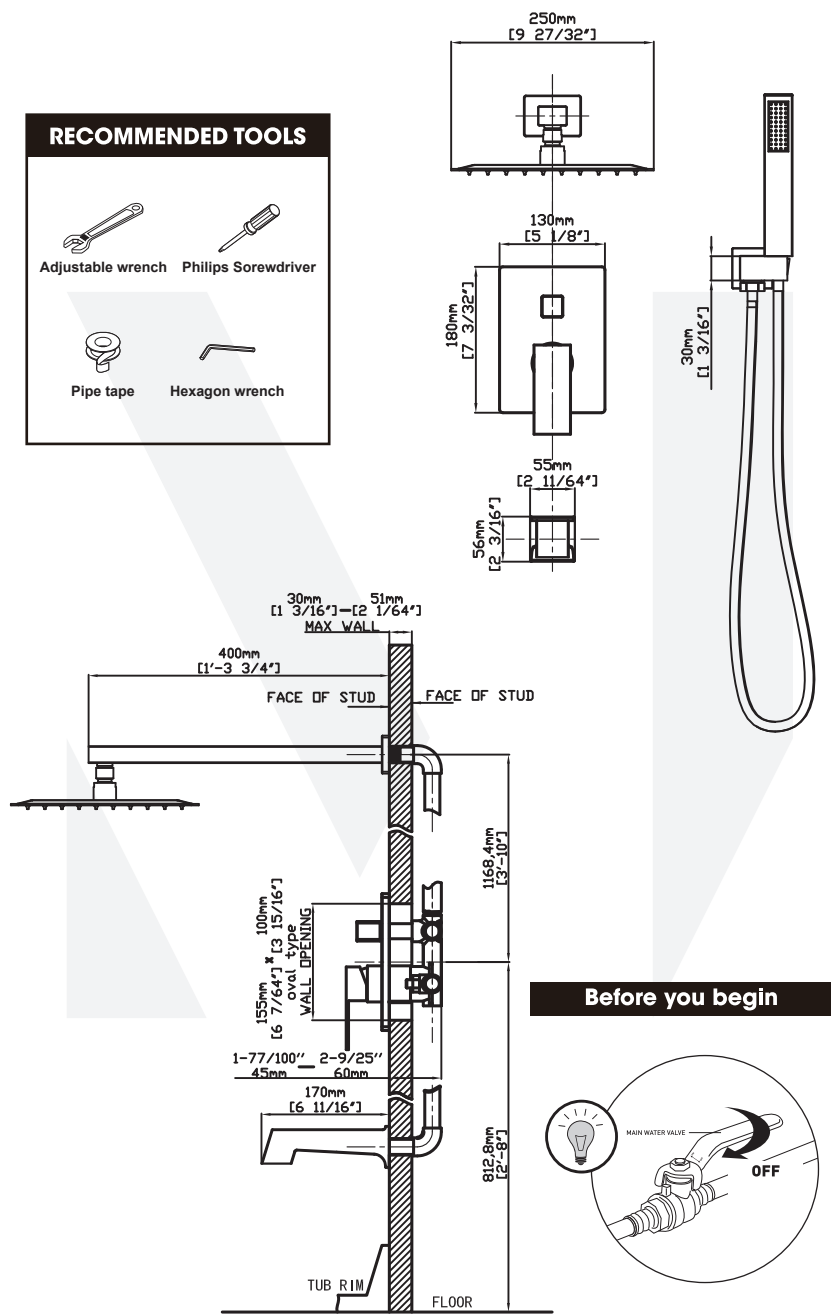

Note: Dimensions are for reference only. Detailed information is in accordance with the final product.

## Installation steps

1

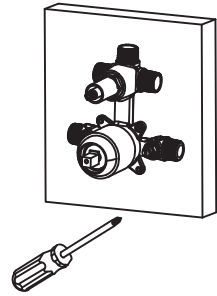

1. Confirm the installed place of the pressure balance valve and fixed on the wood block .

2

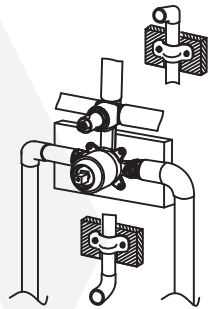

2. Connect the hot&cold inlet tube and outlet tube,then make sure the tube fix stable on the wooden wall.

3

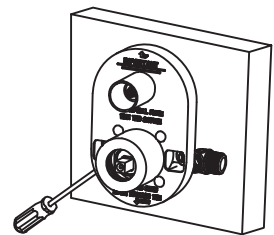

3. Lock the install protective cover into the body. ( 155\*100mm oval type).

## Installation steps

4

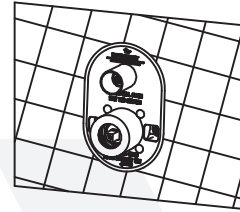

4.Please cut the size of the tile hole according to the size and shape of the protetved cover ( about 5mm bigger than the protetved cover from each side ) . And please put the tile outside the wooden wall ( please noted that wekeep the same central point for the tile hole with the protetved cover ) .

5

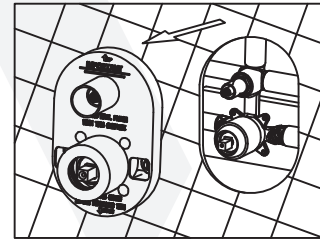

5. Loosen the screw and remove protect cover.

6

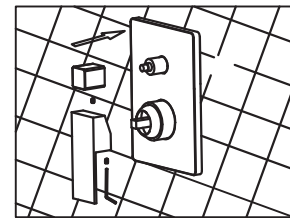

6.Lock the deck plate into the body and cling to the wall. Put on the handle, then tight the screw.

## Installation steps

7

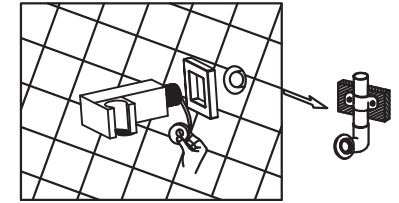

7. Warp the thread of spout with teflon tape (ensure it must warp clockwise).Screw-in to the inlet pipeinside the wall, then install the decorative cover on the wall clingy.

8

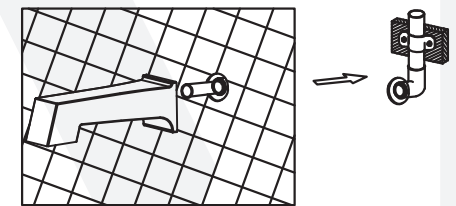

8. Insert the spout to the pipe which outside the wall,then tighten the screw.

9

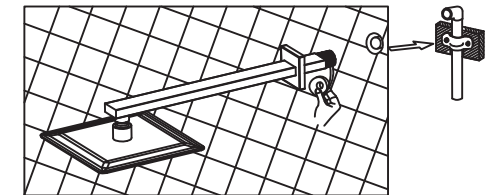

9. Install the shower arm,shower head and flange to the fitting. (stick to the wall) .Tighten the showerhead to the shower arm with the pipe tape.( Make sure the