

10' x 12'

SKU:LGMF8219A

**HARDTOP GAZEBO
WITH DOUBLE ROOF**

Assembly Manual

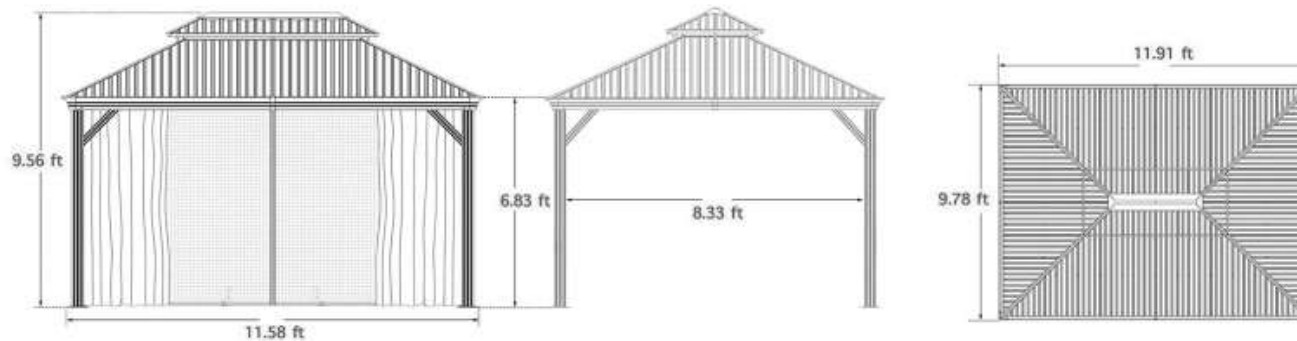

Pre-assembly

TOOLS THAT MAY BE REQUIRED (Not included in boxes)

*NOTE: Tools / equipment are not shown to actual size and scale.



LEVEL

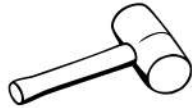

RUBBER Mallet



PHILLIPS SCREW



DRILL



ALLEN KEY



ALLEN KEY

EQUIPMENT REQUIRED (Not included in boxes)

*NOTE: Equipment are not shown to actual size and scale.



SAFETY HAT



GLOVES



SAFETY GOGGLES



STEPLADDER

Matters needing attention



1. Two or more people are required for assembly.



2. Do not fully tighten screws prior to complete assembly.

MOUNTING BLUEPRINT

Gazebo 10×12

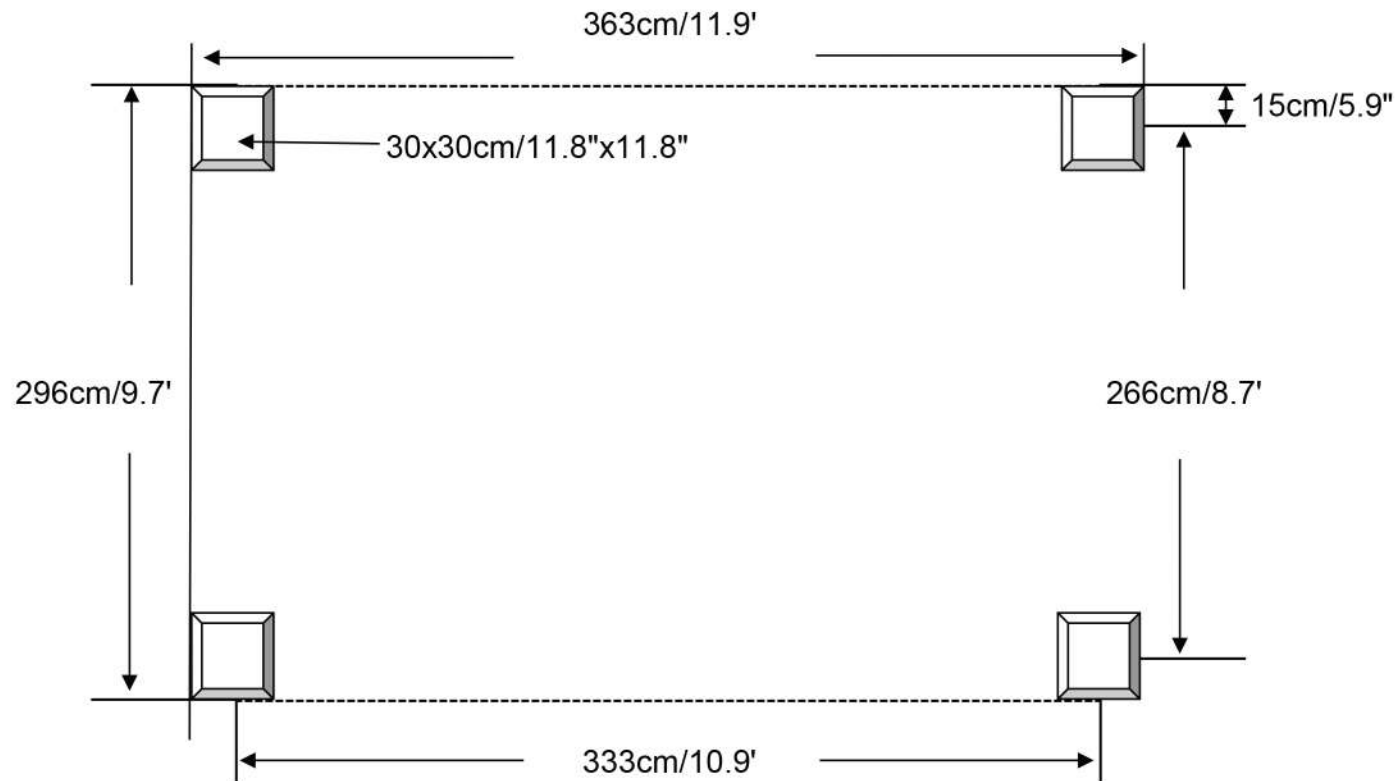

1

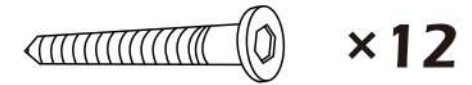
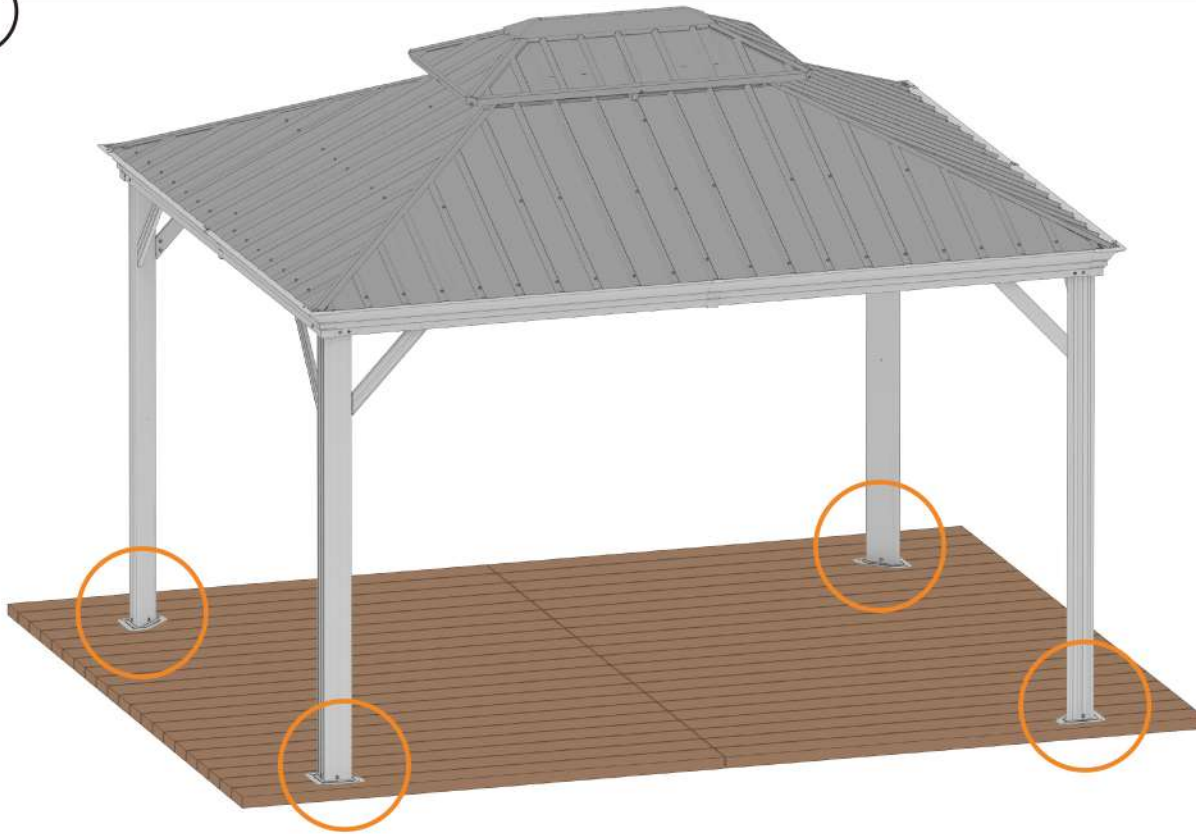

If the deck is hard wood and the depth of it is over 3 inch, you can use **5/16 in. x4 in. Structural Wood Screw** to mount the gazebo.

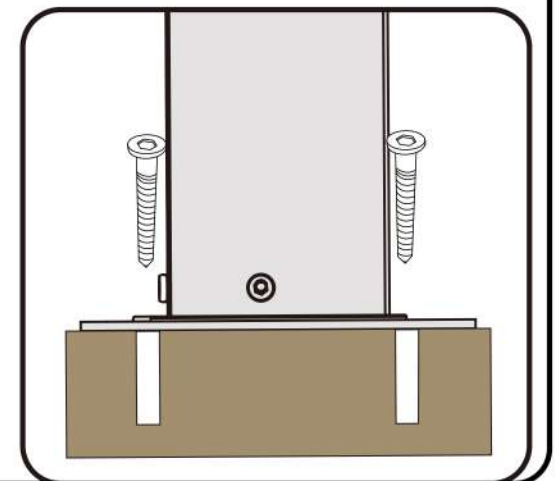
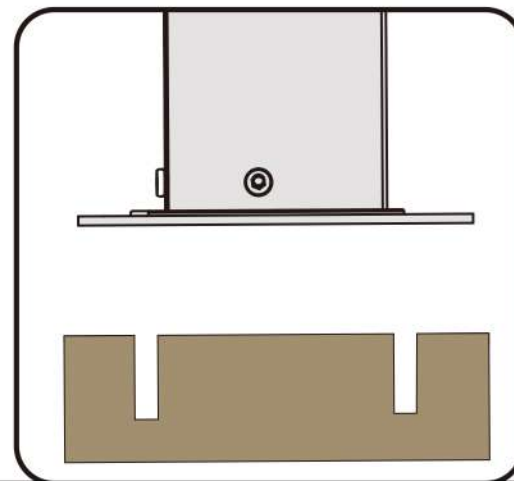

2

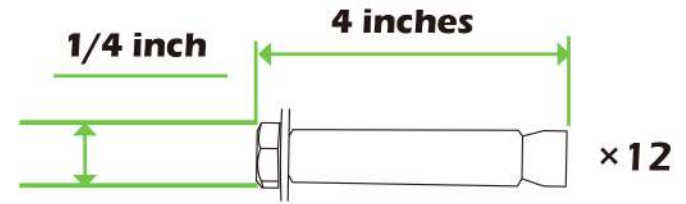
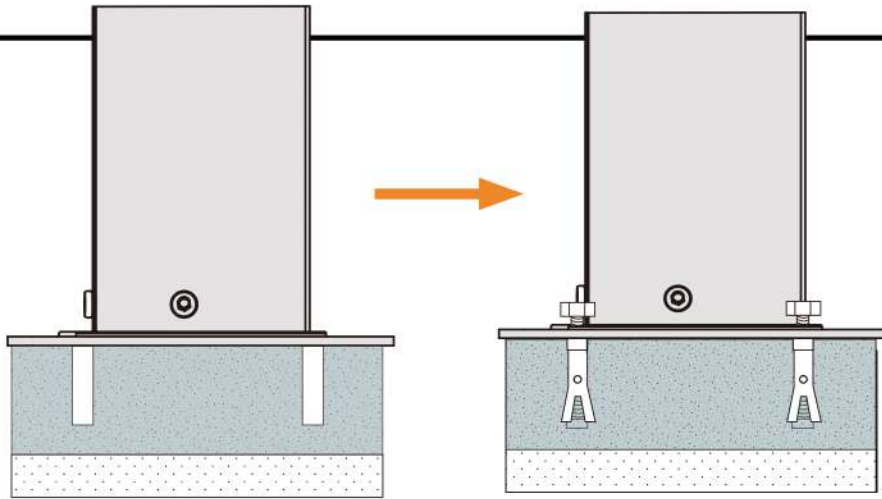

If the ground is concreted and the depth of it is over 3 inch, you can use 1/4 inch expansion bolts to mount the gazebo

3



Or you can make a concrete footing for gazebo, **11.8x11.8x11.8 inches** is recommended. Use expansion bolts to mount the gazebo like ② shows.



IMPORTANT:
Anchor is not recommended

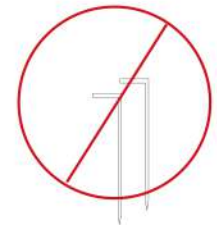

CHECK LIST



A × 4



B × 2

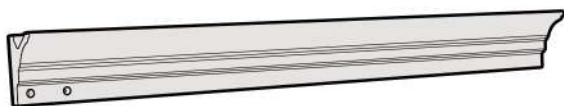

B1 × 2



B2 × 2



C × 2

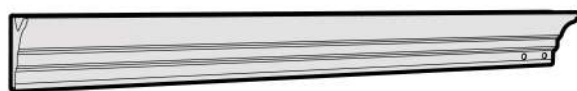

C1 × 2



C2 × 2



D × 2

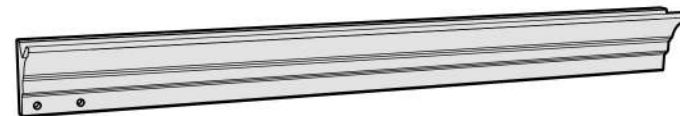

D1 × 2



D2 × 2



E × 2

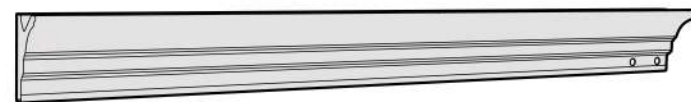

E1 × 2



E2 × 2



F × 4

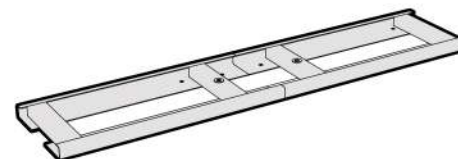

G×4



H×4

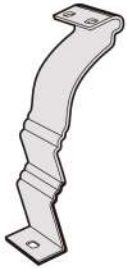

H1×4

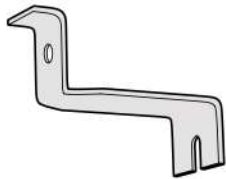

H2×1

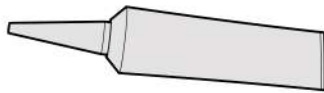

J1×4



J2×4



K×1

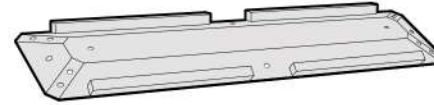

K1×1

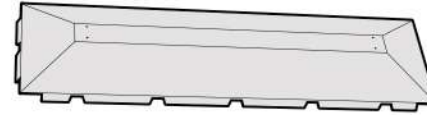

L×4

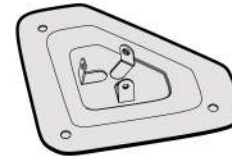

M×4

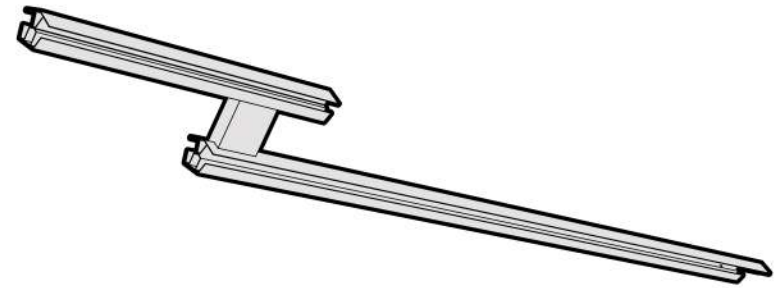

N×4



P×2



P1×2

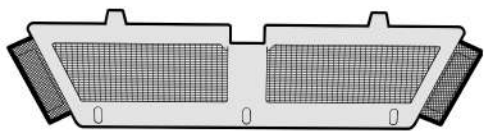

Q×2



Q1×2

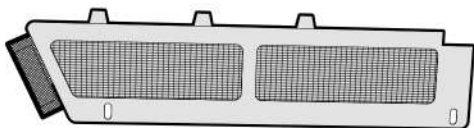

Q2×2

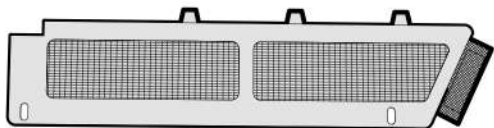

R×8

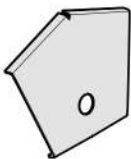

S×104

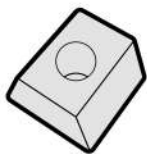

T1×2



T2×2



U1×4



U2×4



U3×4

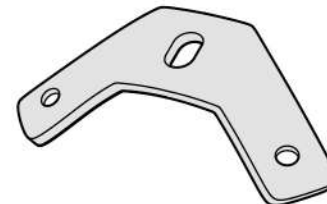

U4×4



Y×4

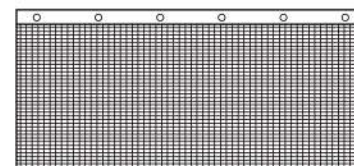

Y1×4

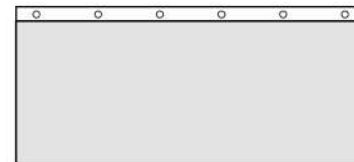

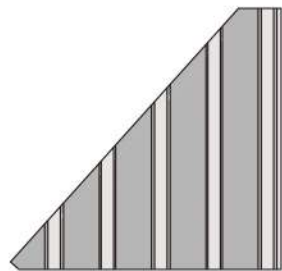

V1×2

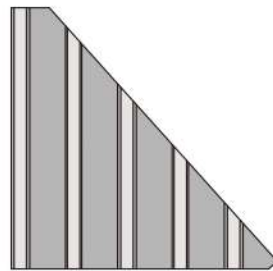

V2×2

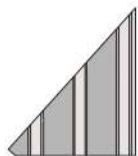

V3×2

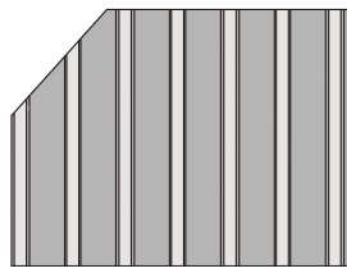

V4×2

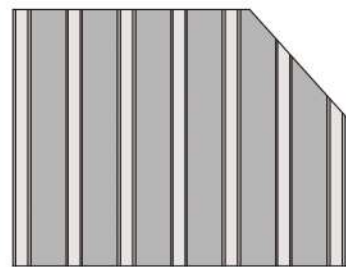

V5×2

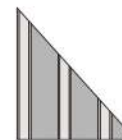

V6×2

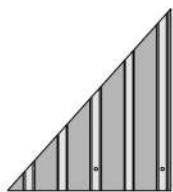

W1×2

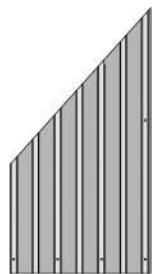

W2×2

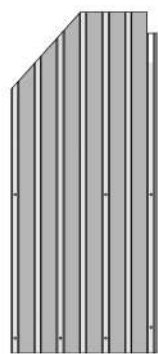

W3×2

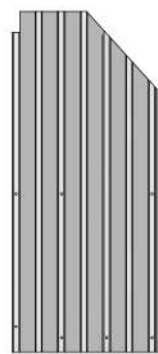

W4×2

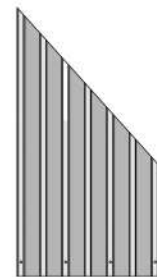

W5×2

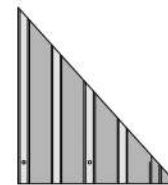

W6×2

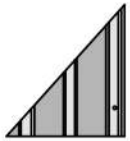

X1x2

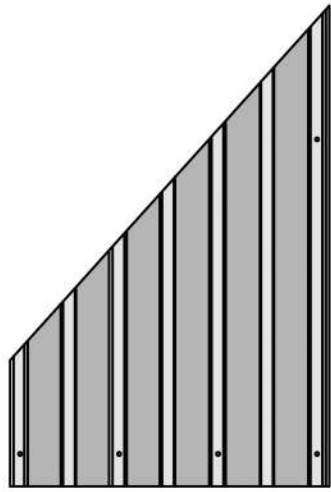

X2x2

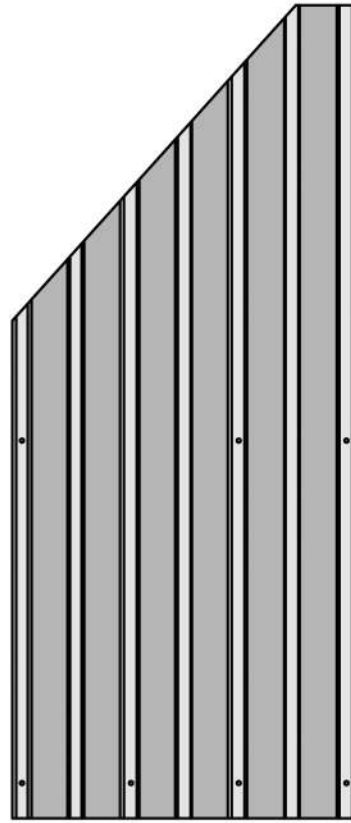

X3x2

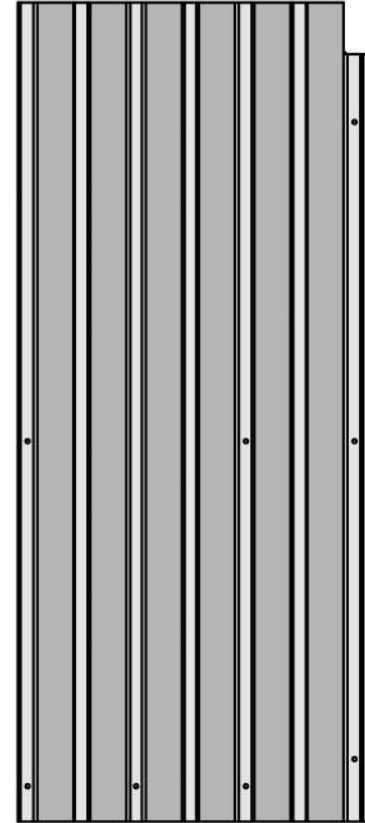

X4x2

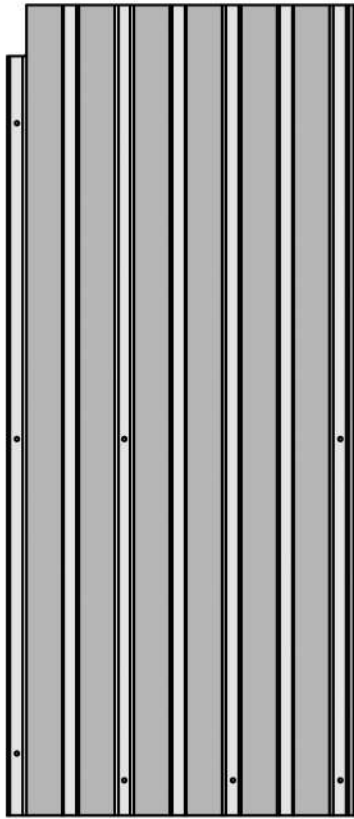

X5×2

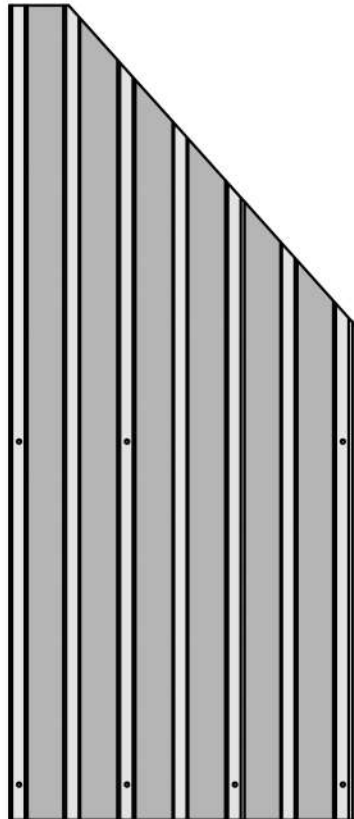

X6×2

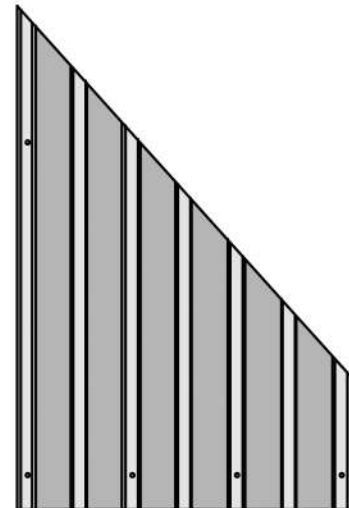

X7×2

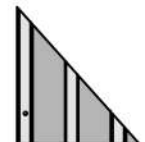

X8×2

Z×56



Z1×4



Z2×4



Z3×4



Z4×4



1#×206

(M6×16)



2#×16

(M6×20)



3#×16



4#×104



5#×64

(M6×28)



6#×8

(M6×45)

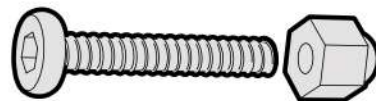

7#×28

(M6×50)

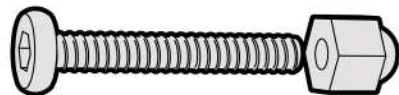

8#×4

(M5×16)

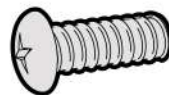

9#×24

(ST4.8×13)

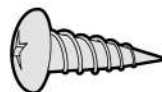

10#×4

(M6×25)

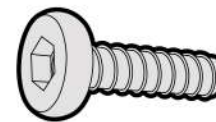

11#×8

(M6×10)

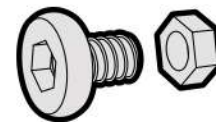

12#×1

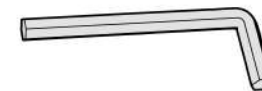

13#×1

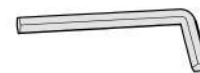

14#×1

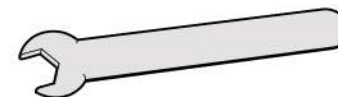

15#×1

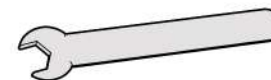

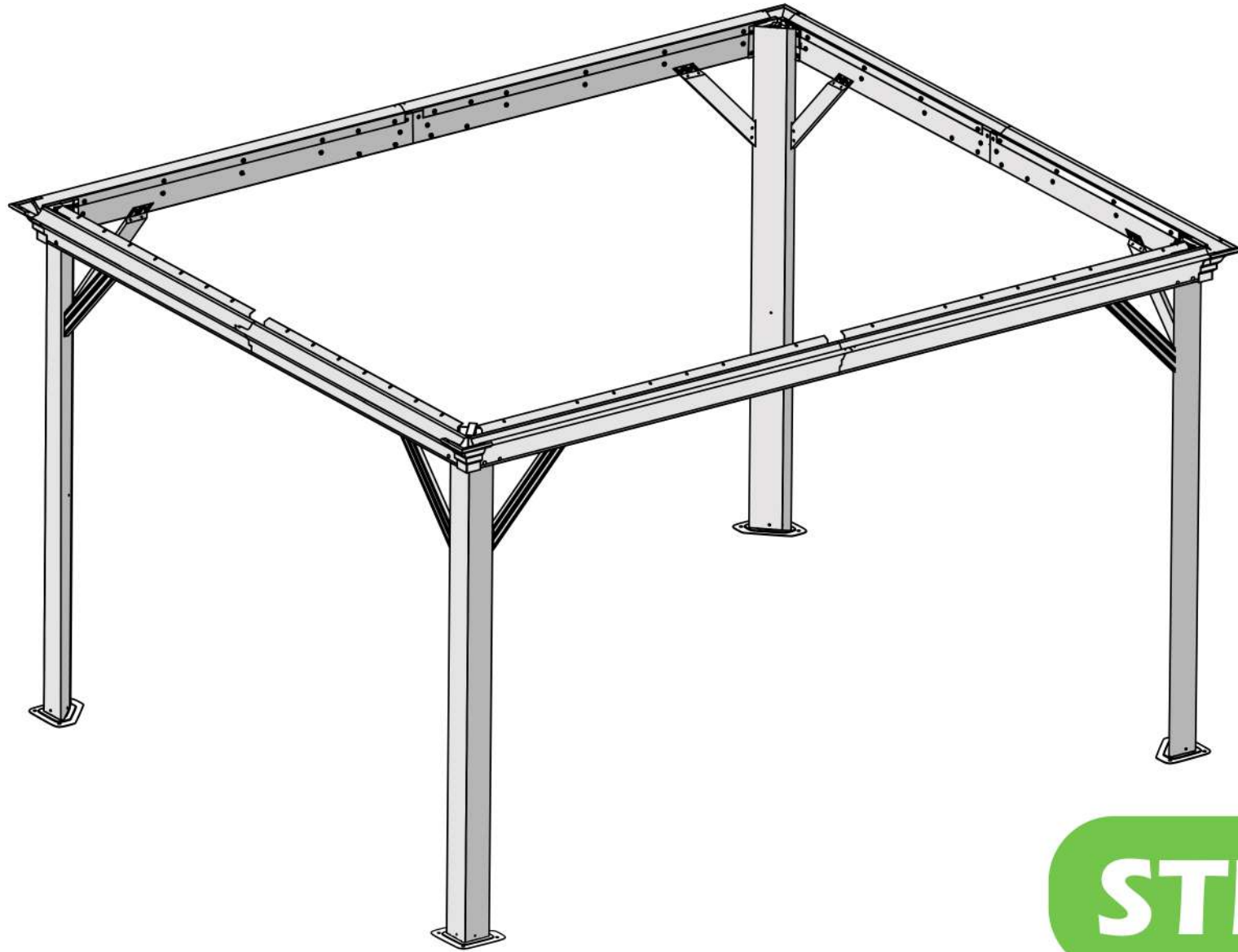

STEP 1



A × 4



L × 4



1# × 12

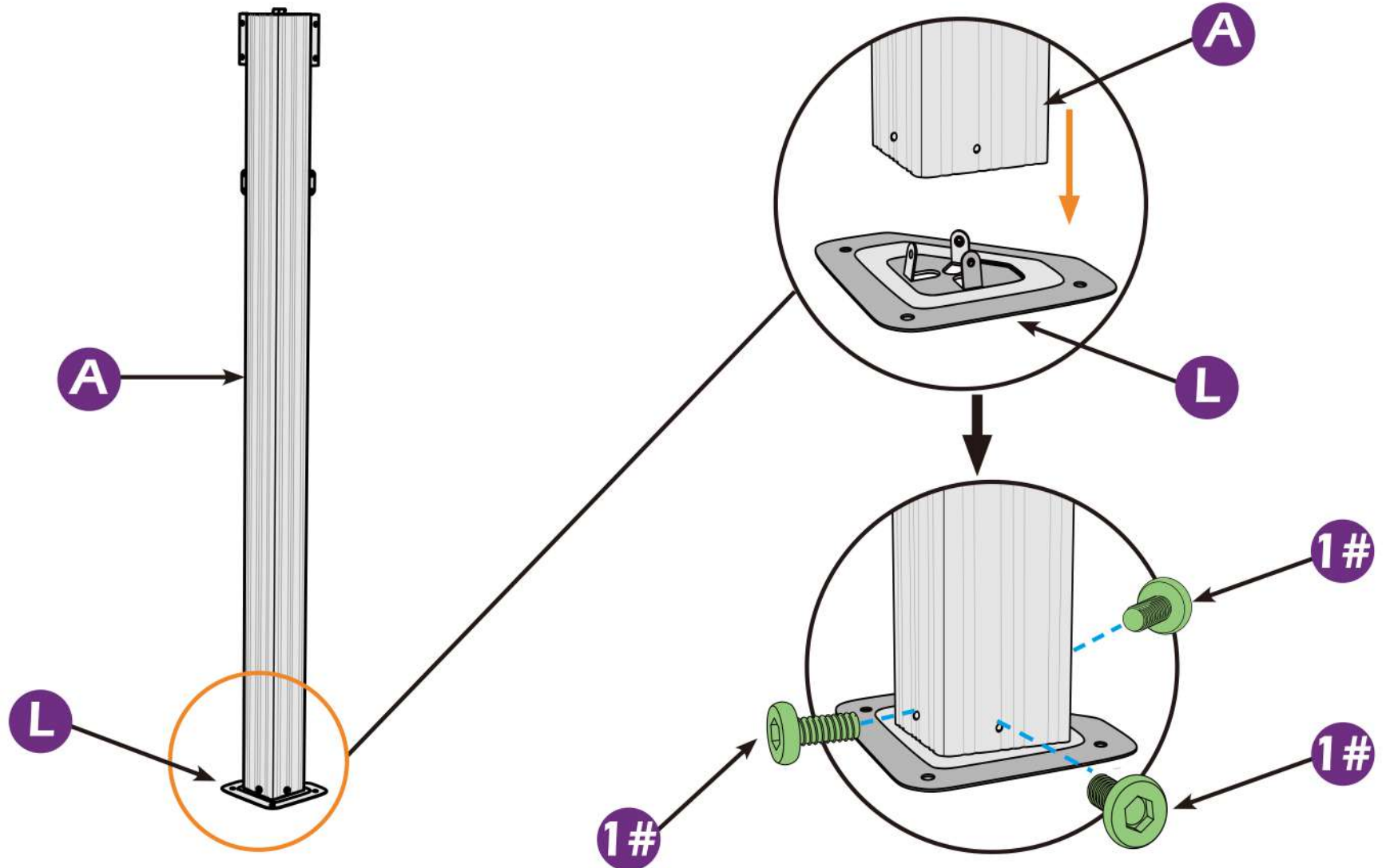

STEP 1



B × 2



F × 2

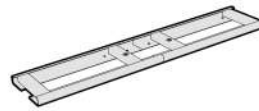

C × 2



1# × 8

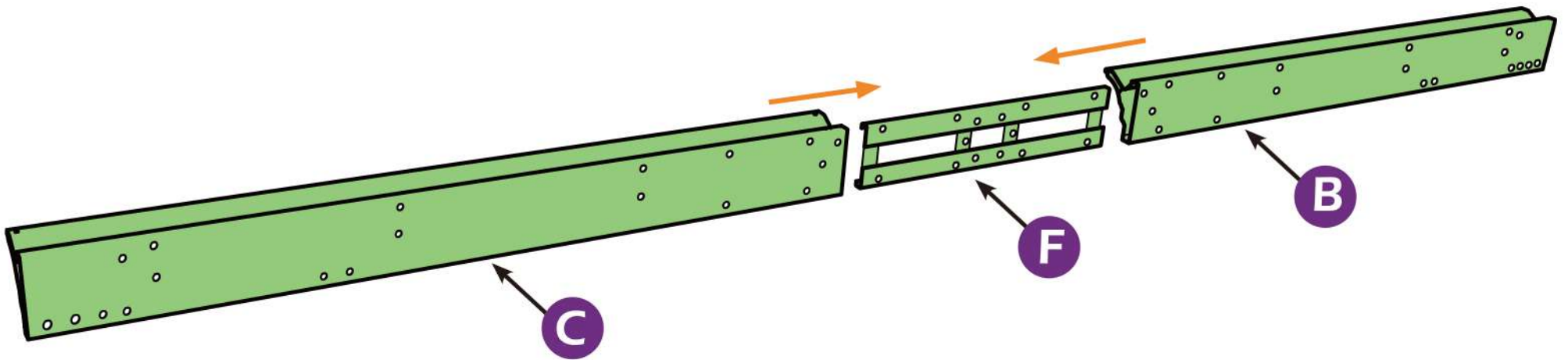

STEP 1

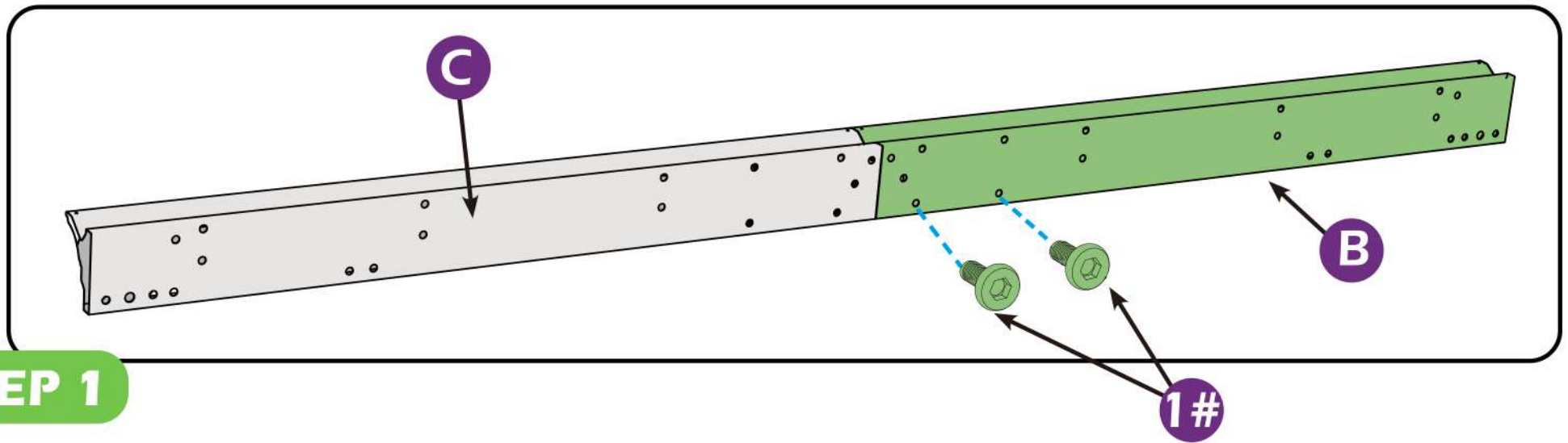
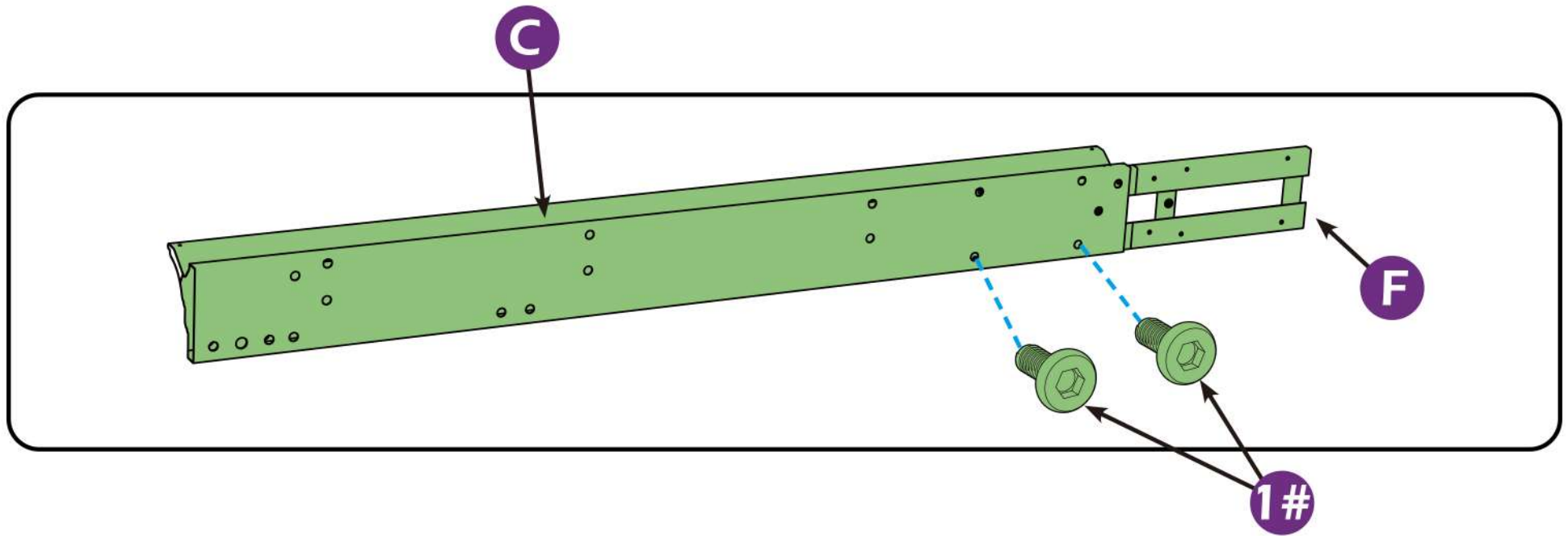

STEP 1



C1 × 2



1# × 20



B1 × 2

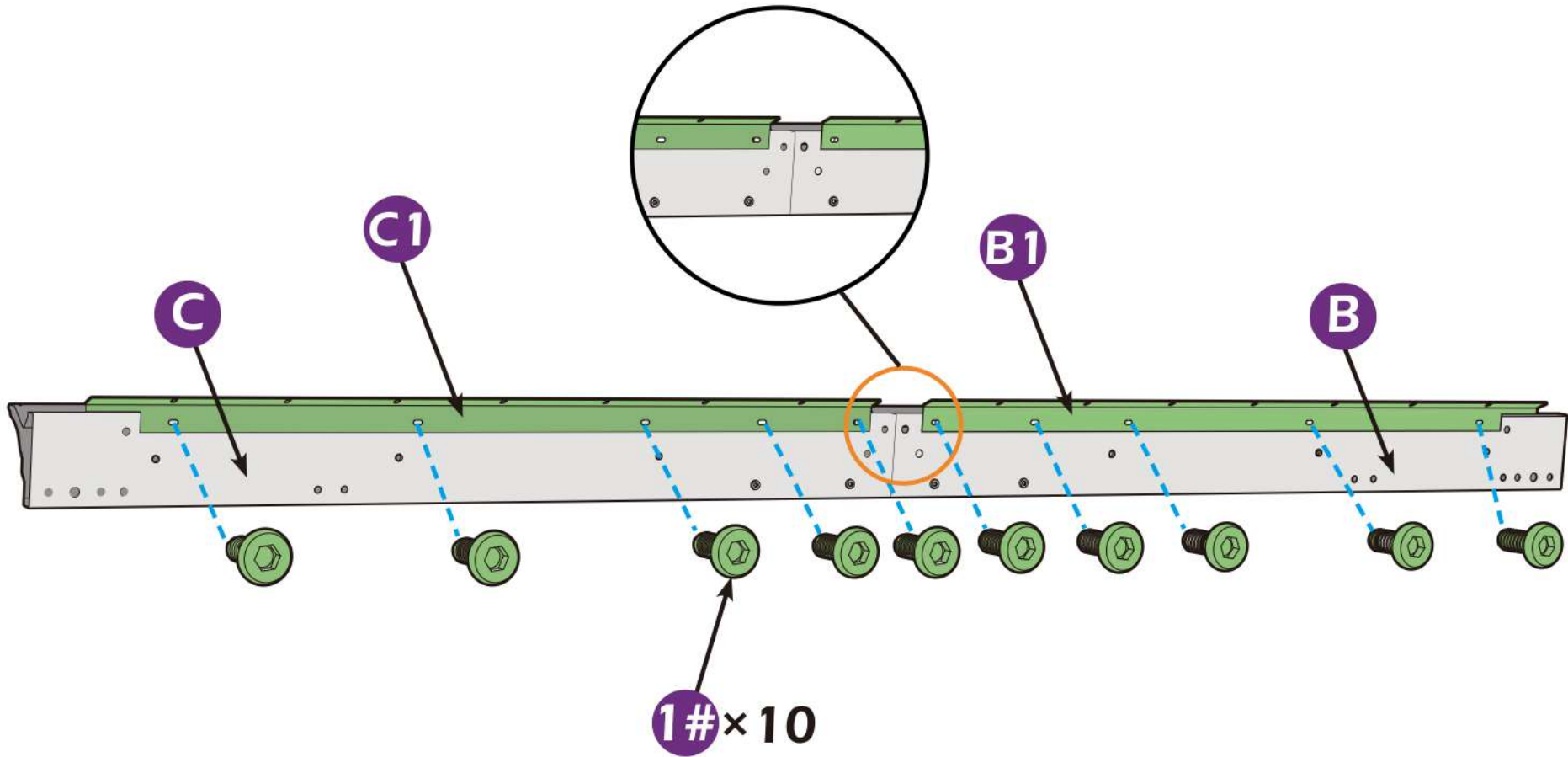

STEP 1



D × 2



F × 2

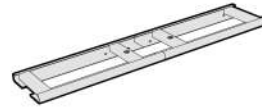

E × 2



1# × 8

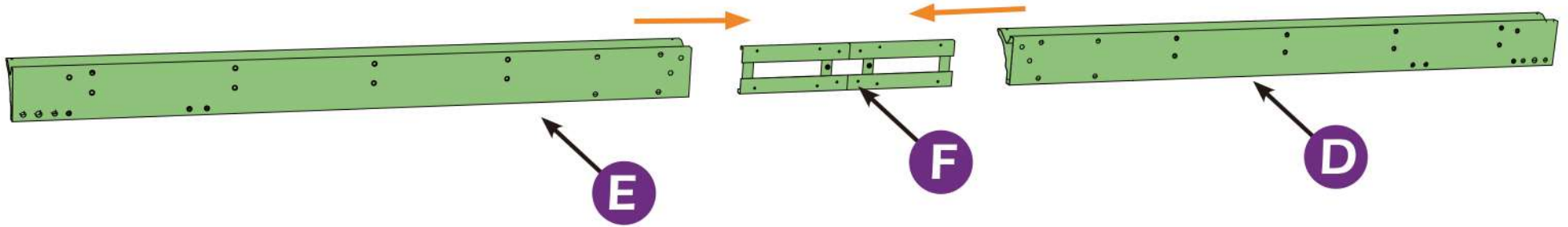

STEP 1

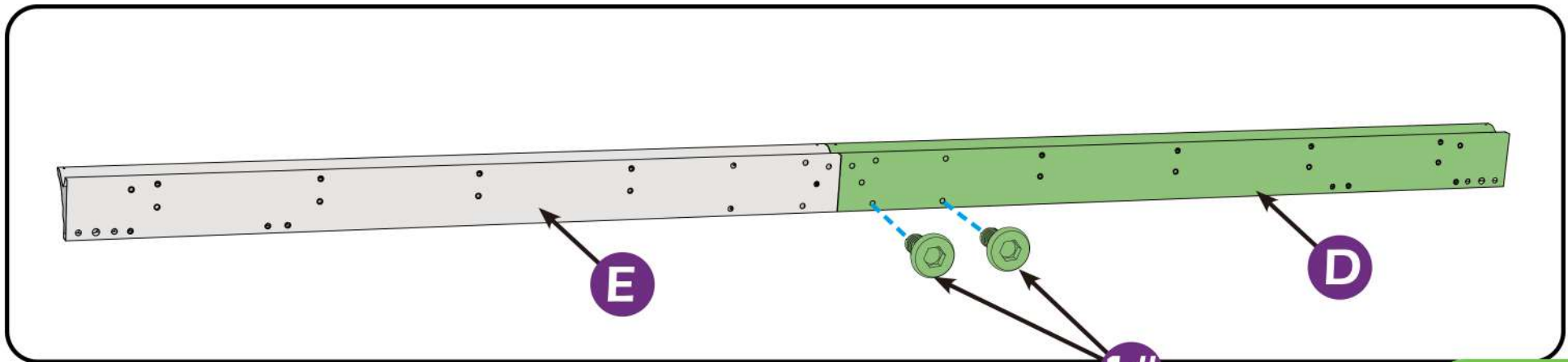
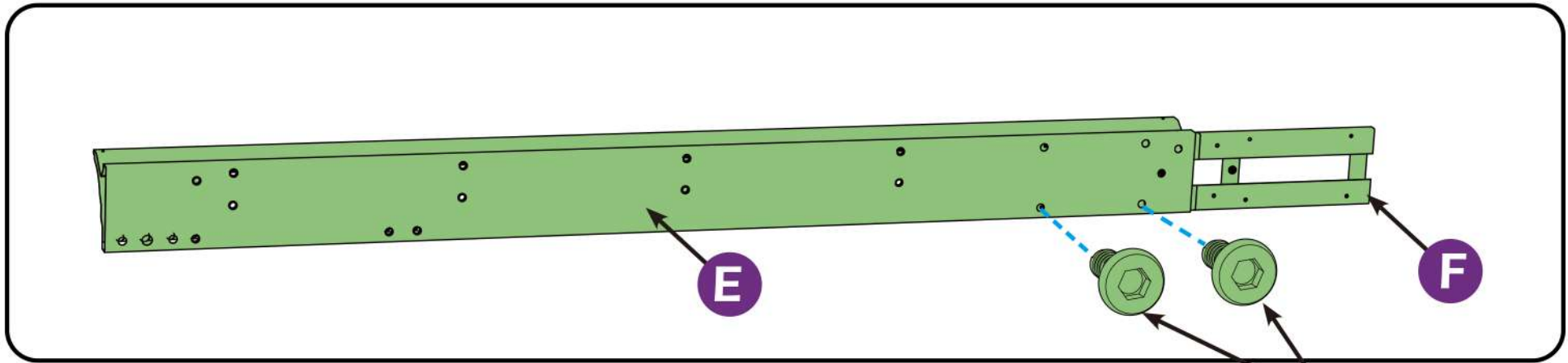

STEP 1



E1 × 2



1# × 24



D1 × 2

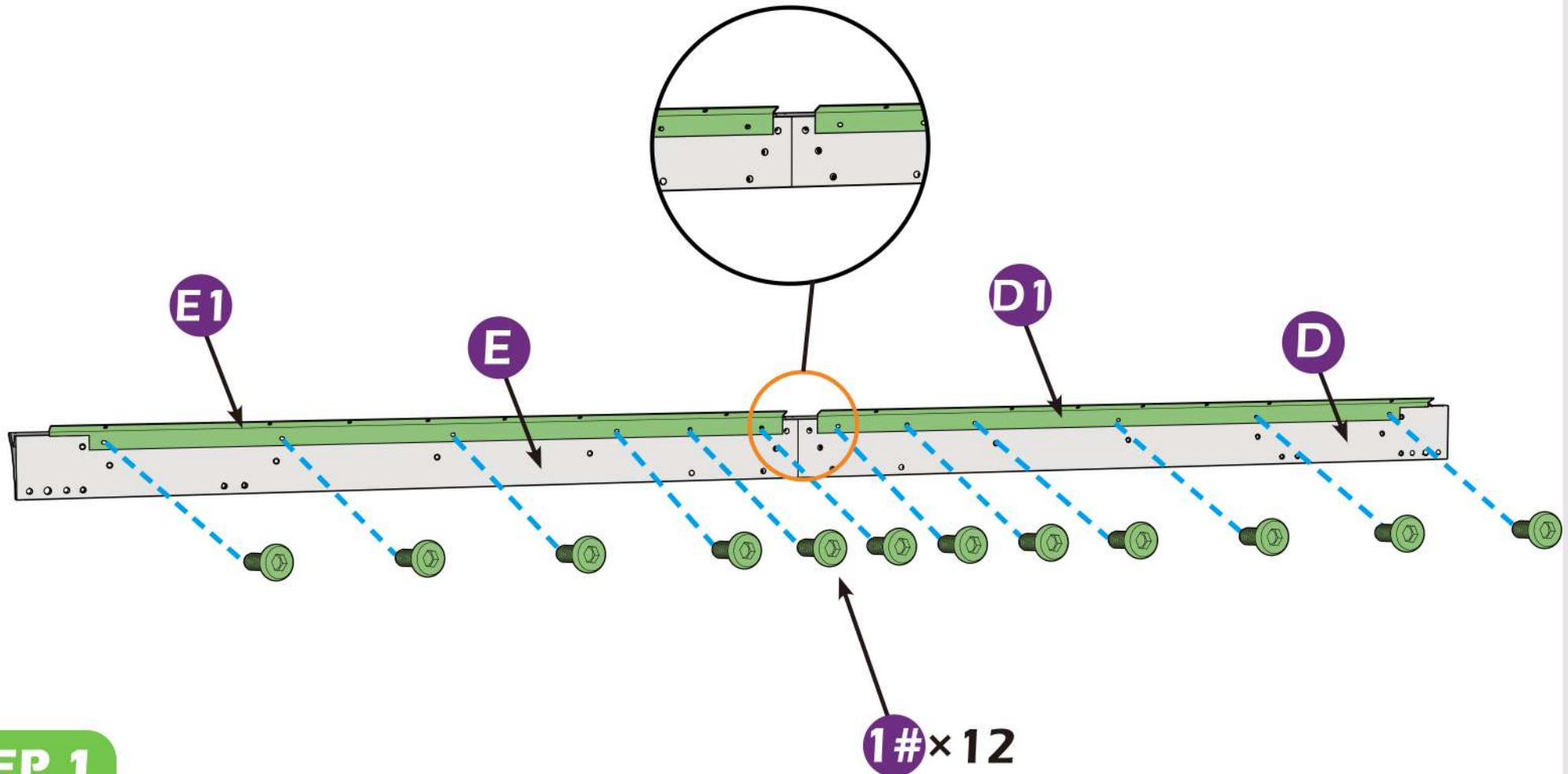

STEP 1



2#×16



3#×16

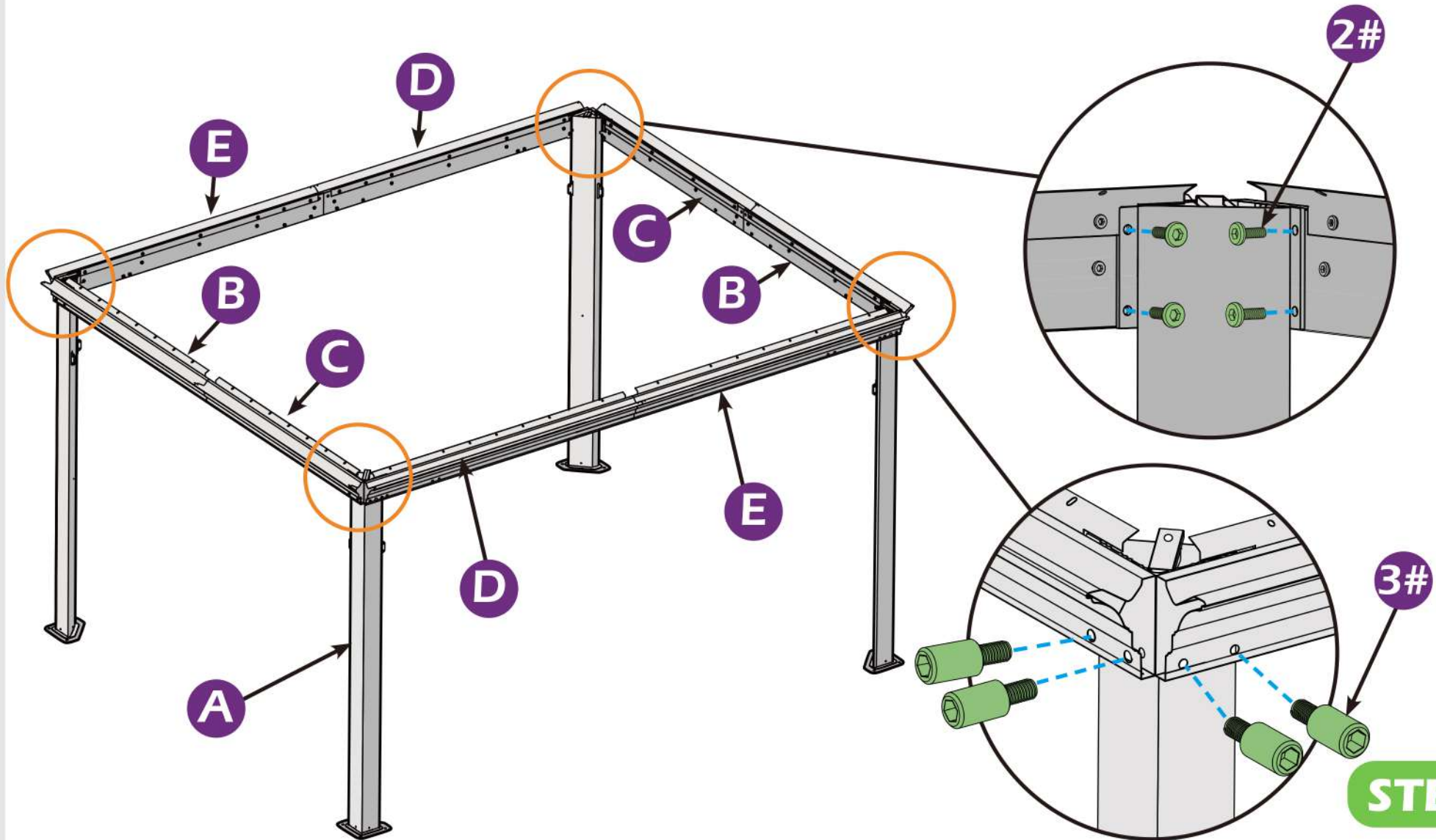

STEP 1



J1 × 4



1# × 32



J2 × 4

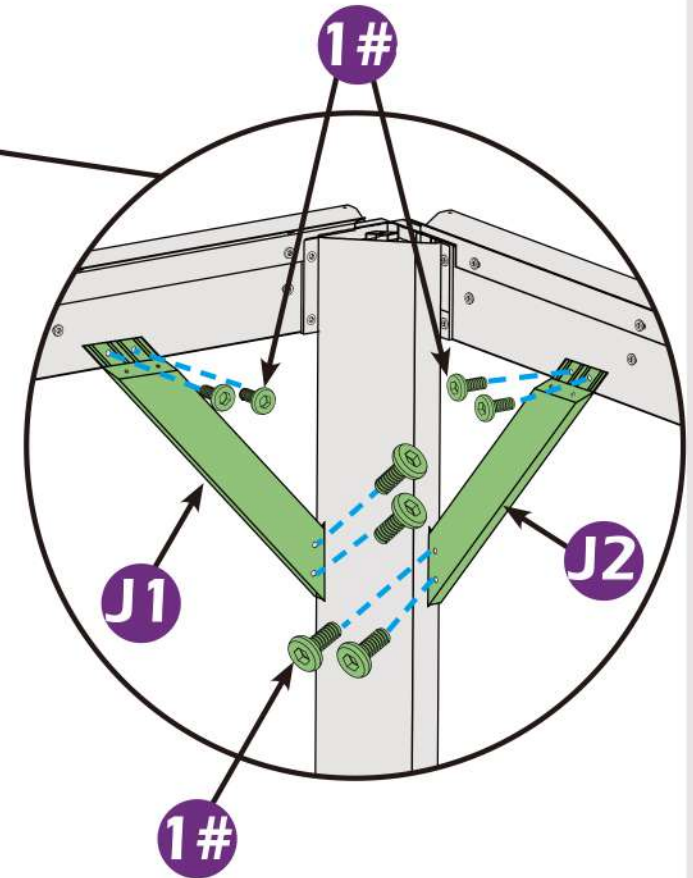
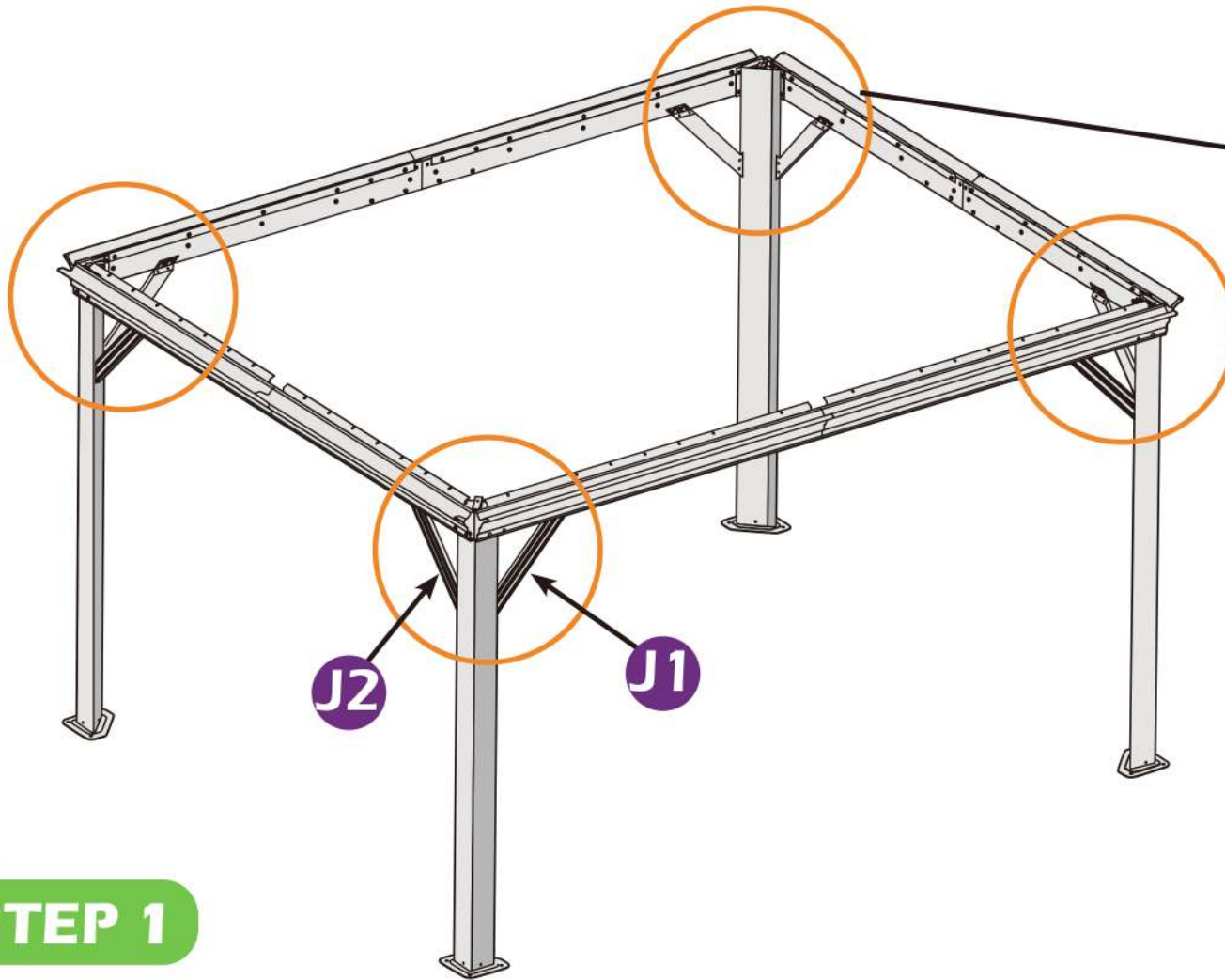

STEP 1



G × 4



9# × 16

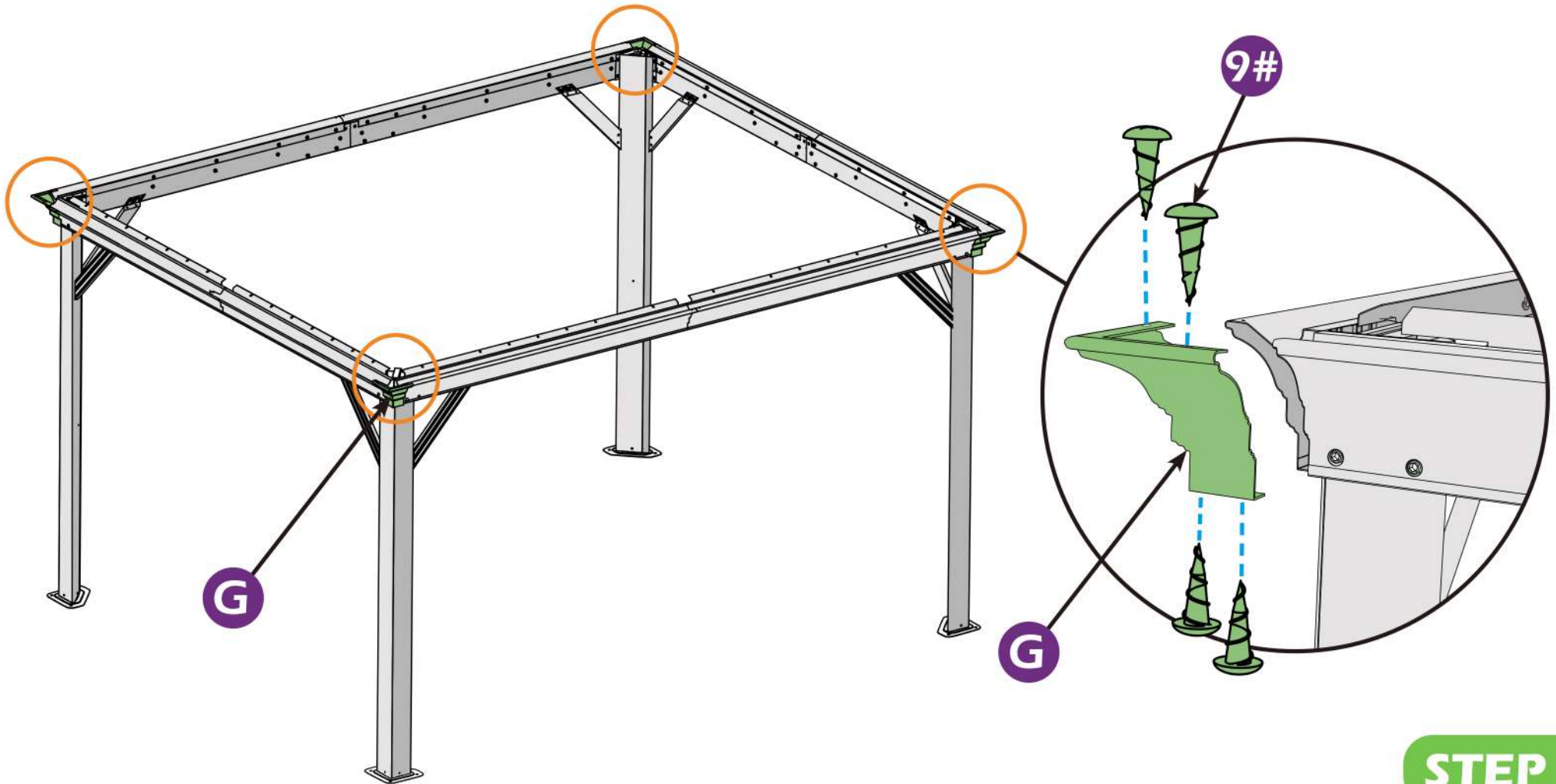
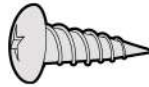

STEP 1



STEP 2



K × 1

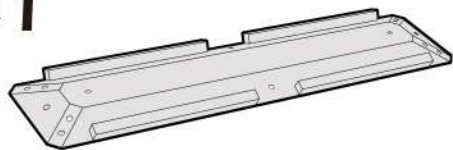

K1 × 1

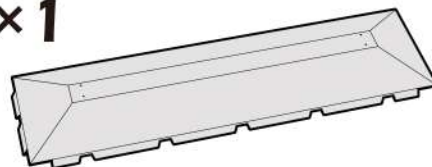

1# × 2

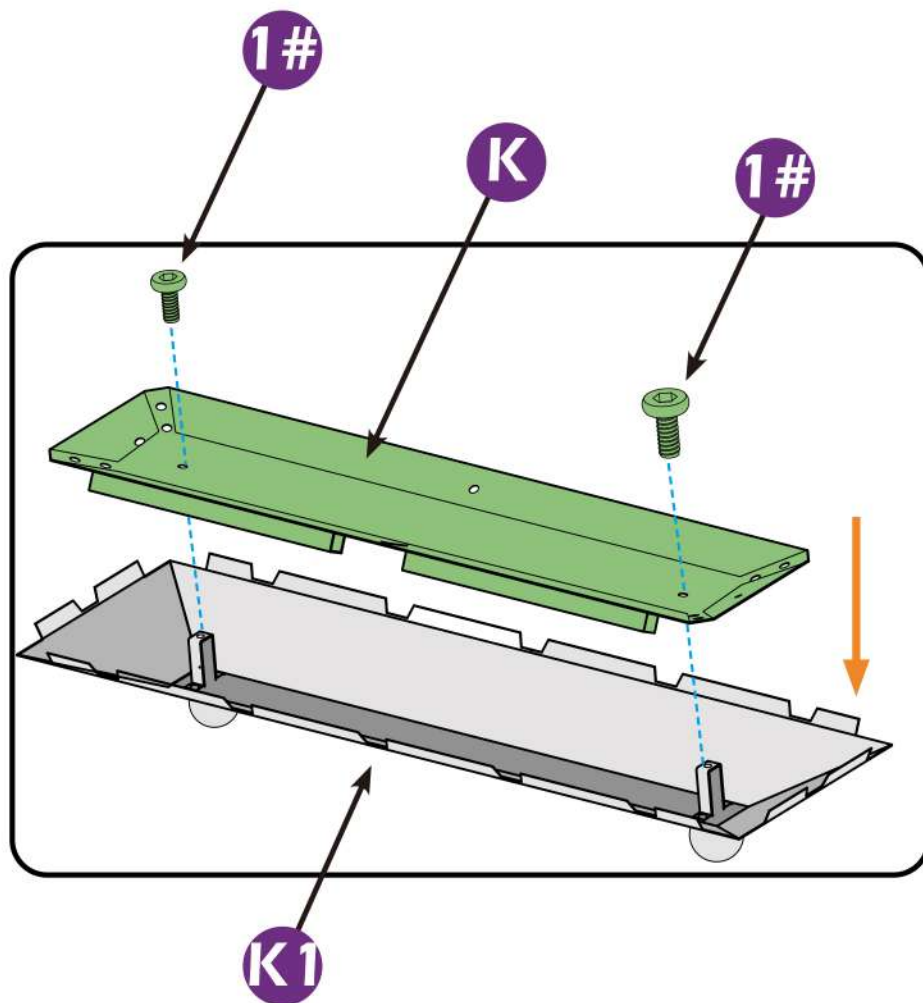
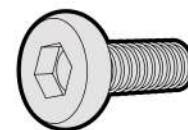

Don't fully tighten the screw **1#**, It might cause problem on roofs installation.

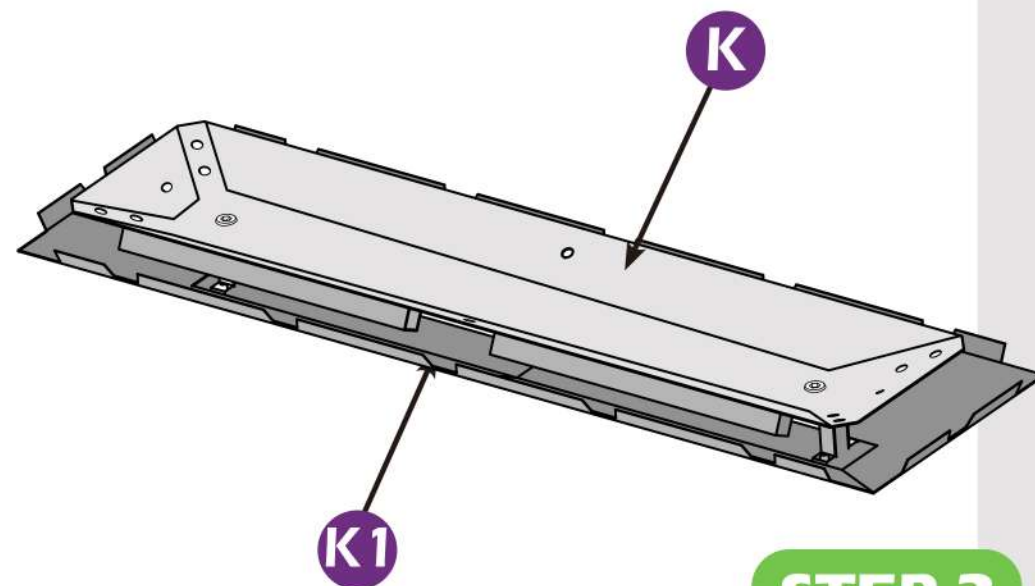

STEP 2



M × 1

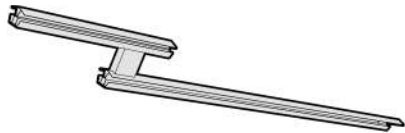

N × 1



1# × 3

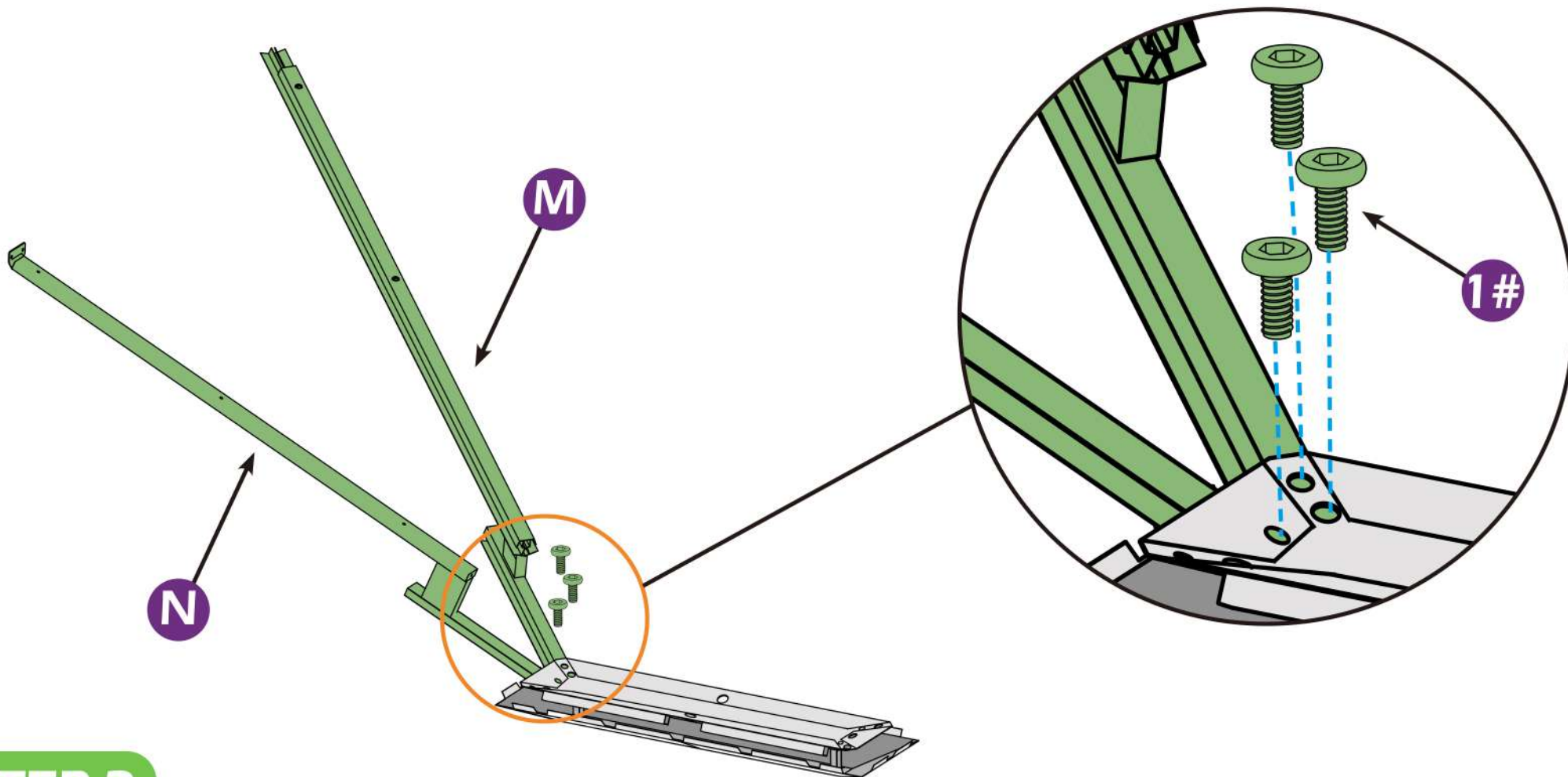
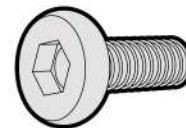

STEP 2



1# x 3

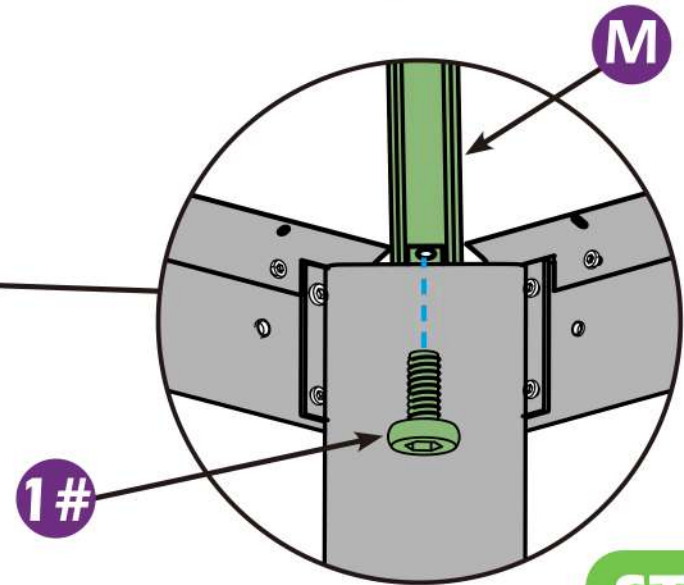
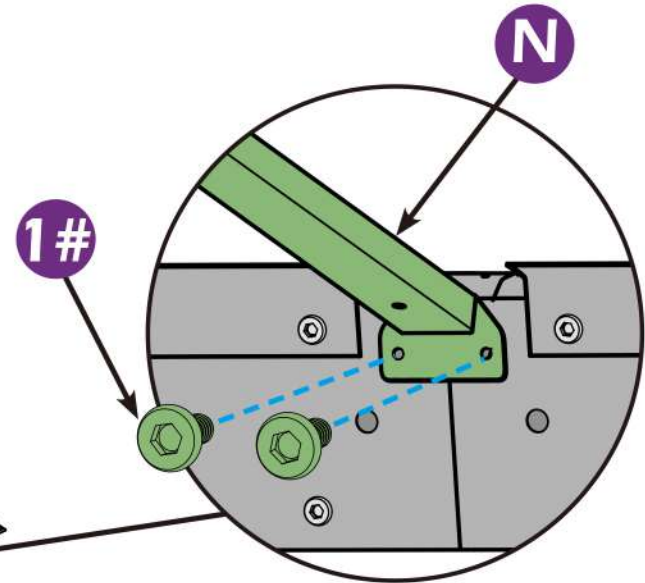
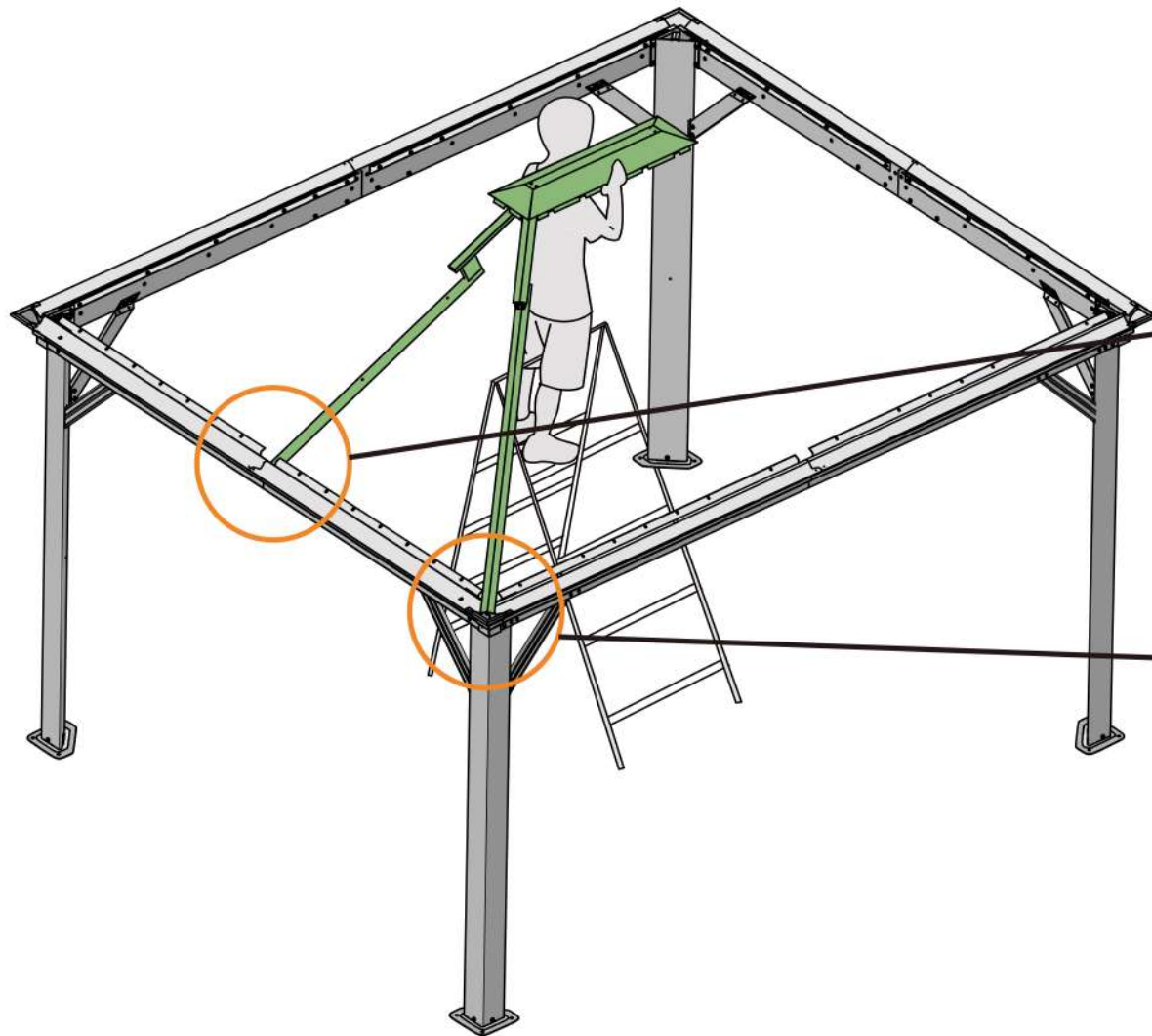
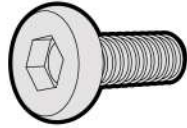

STEP 2



M × 3

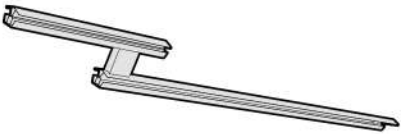

1# × 9

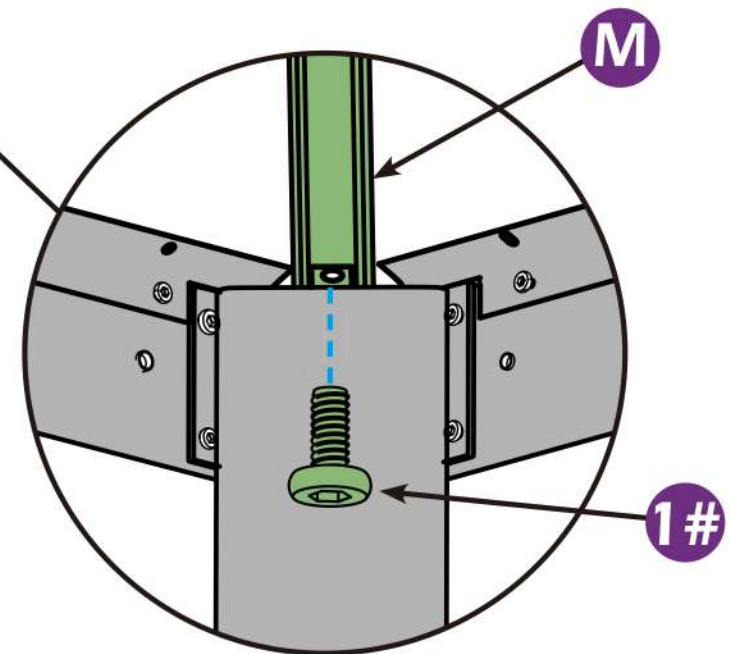
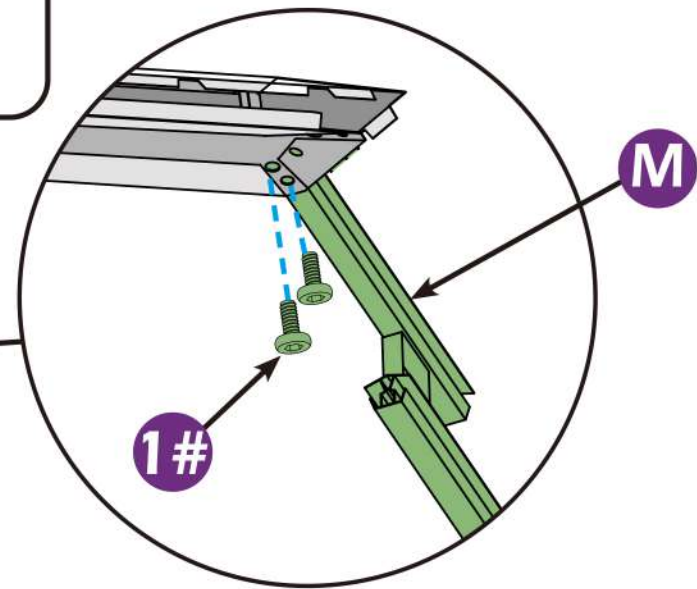
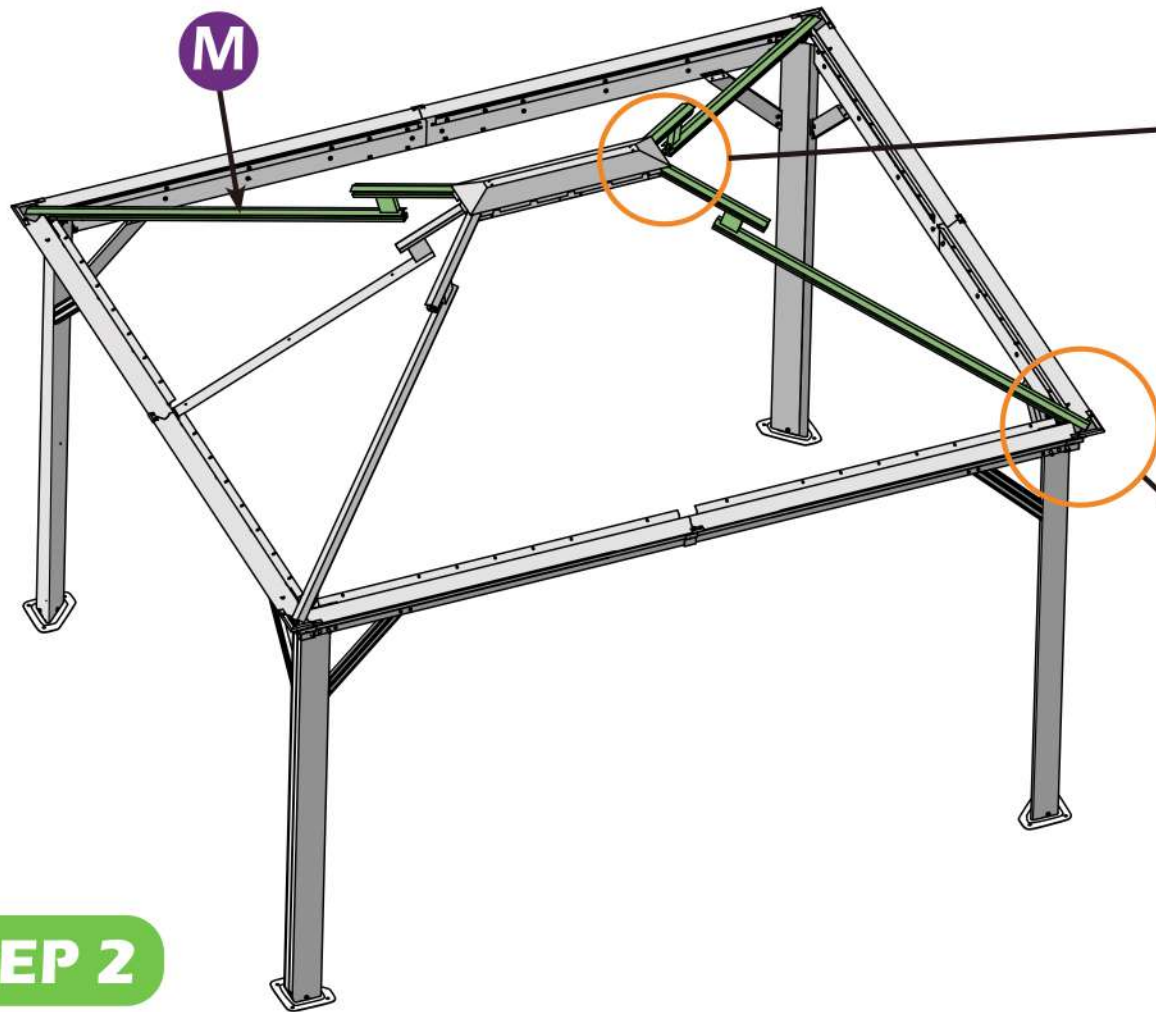
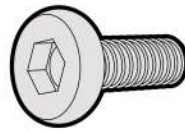

STEP 2



N × 1



1# × 3

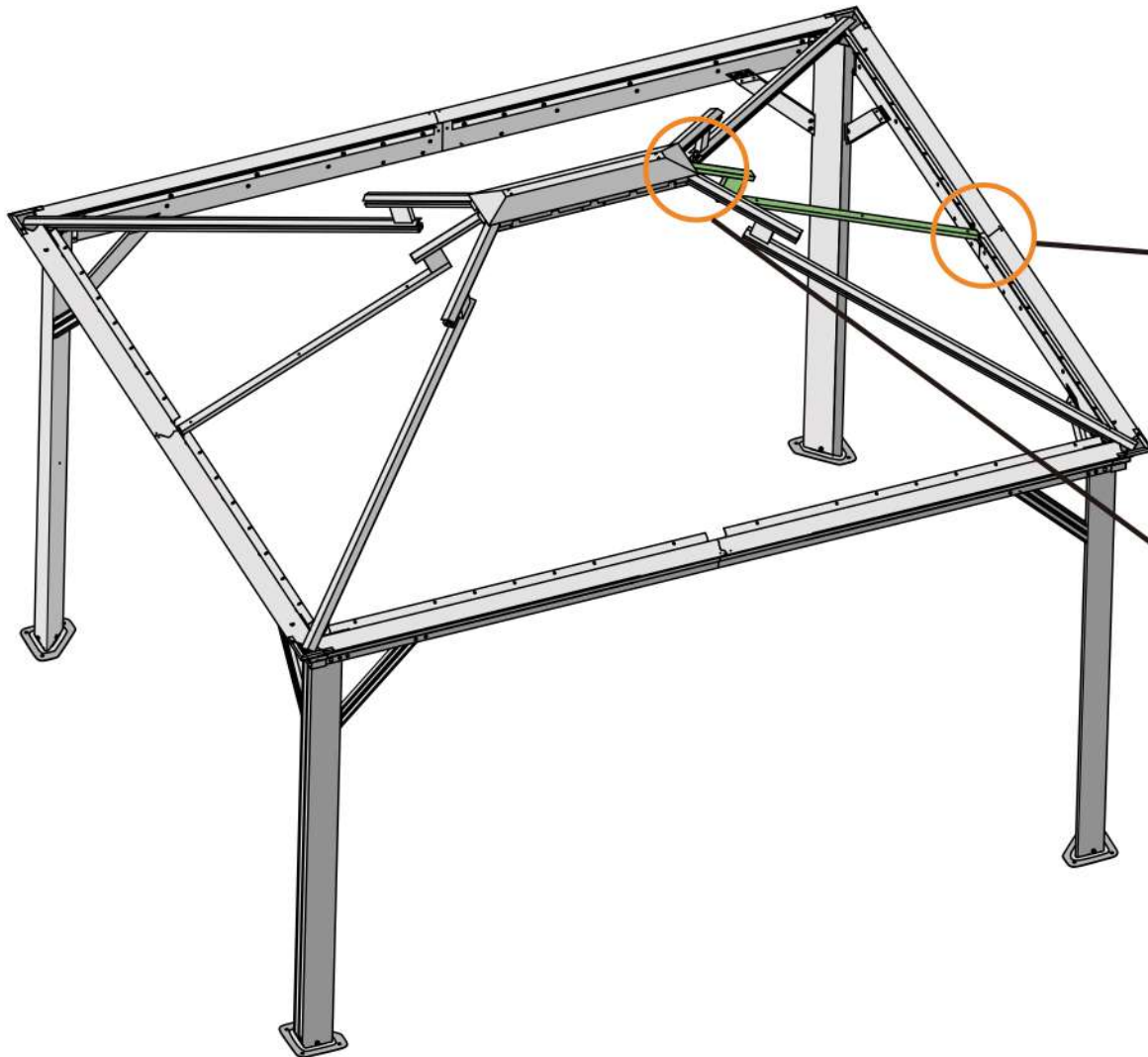
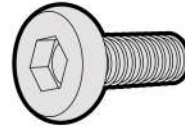

1#

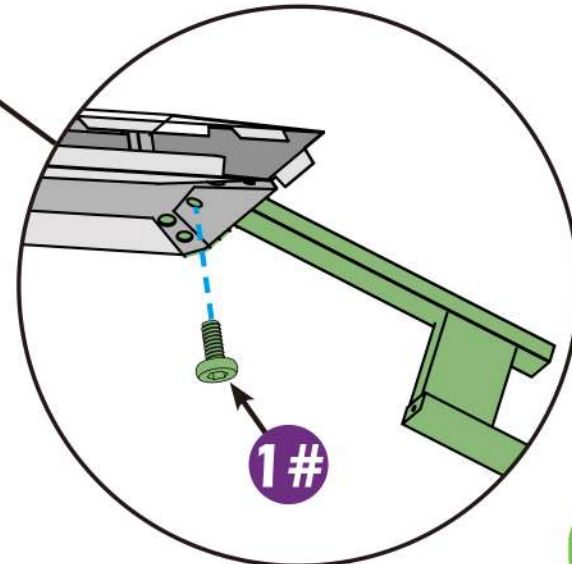
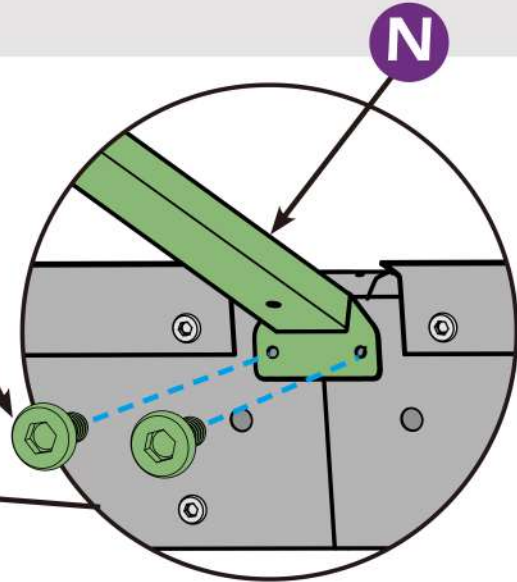

STEP 2

Check the the frame as pictures below shows.

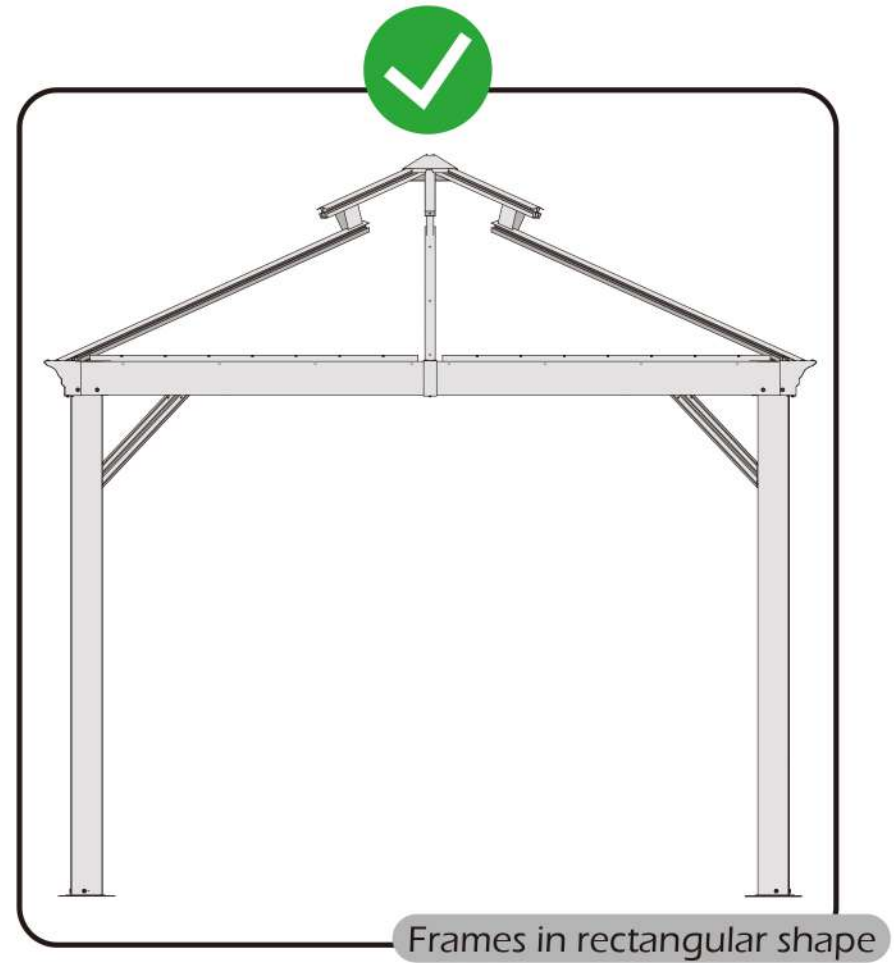
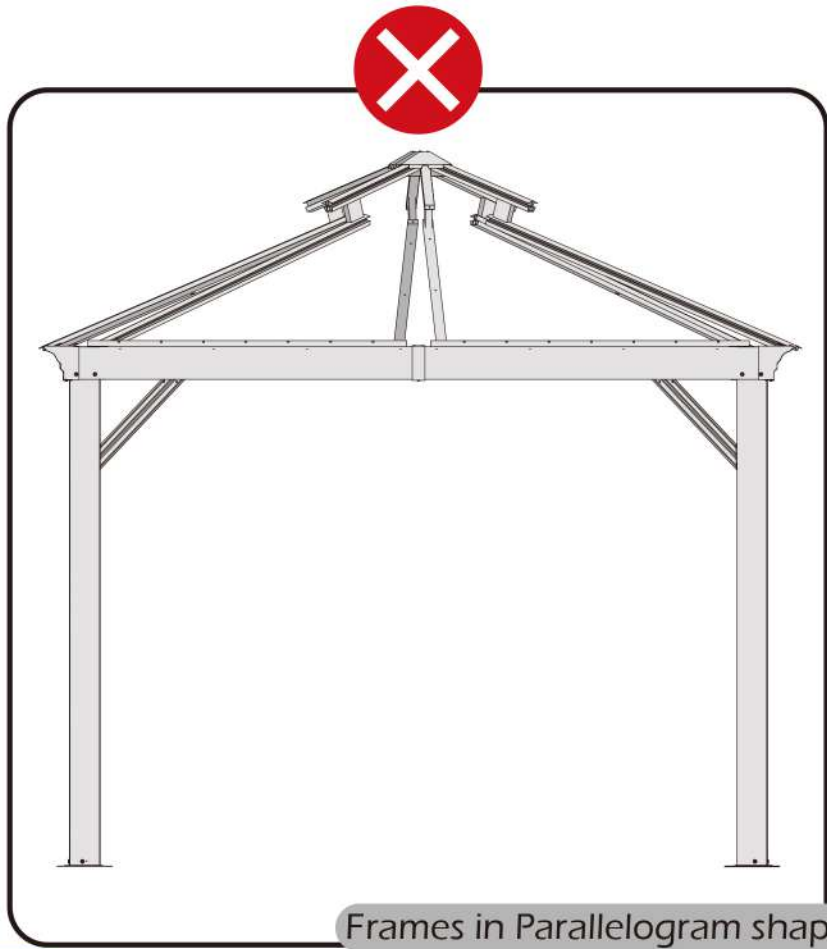

STEP 2