

Boyel Living

Website: www.boyelliving.com
Service contact: service@boyelliving.com
Customer Service : 323-982-8955 833-998-6986

SHOWER FAUCET

Installation Manual



MB/BN/BG/ORB/CH

SHOWER SET INSTALLATION

BEFORE YOU BEGIN

We recommend consulting a professional if you are unfamiliar with installing plumbing fixtures. We accept no liability for any damage to the plumbing, floor, walls, tub, or for personal injury during installation.

Observe all local plumbing and building codes.

Unpack and inspect the product for shipping damage. If any damage is found, contact our Customer Relations team at 323-982-8955 or send emails to hd@boyelliving.com.

GETTING STARTED

- Ensure that you have gathered all the required materials that are needed for the installation.
- For the following installation instructions, it is assumed that the wall has been opened and that the existing shower set has been removed.
- Before you begin, the main water supply to your home should be shut off.

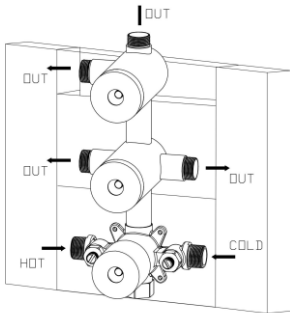

TOOLS AND MATERIALS:

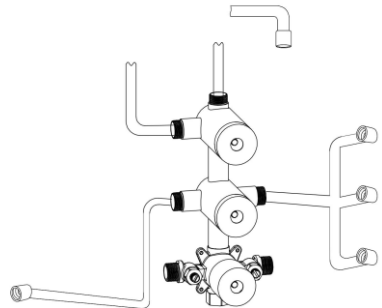
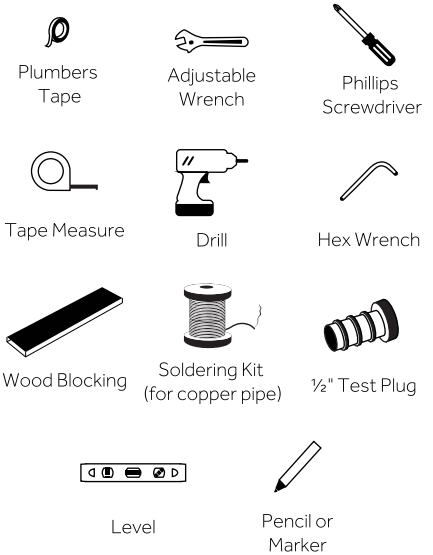

SHOWER SET INSTALLATION

Step 1: Valve Installation

1. To prepare for installation, wood blocking should be installed between the two studs where the valve will mount. The face of the wood blocking should rest $1\frac{1}{4}$ " behind the face of the wall studs.

Important: Take into consideration the thickness of the finished wall materials, such as tile, when calculating measurements.

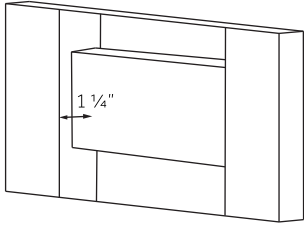

2. Secure the valve to the prepared wood blocking using the provided hardware. Ensure that the "cold" inlet is pointing to the right, and the "hot" inlet is pointing to the left. Use a level to ensure that the valve is straight and level. Leave the protective sleeves on the valve stems until your finished wall is complete, and you are ready to install the trim pieces.

Important: Handle screws may be located in the small box containing other hardware. Do not discard.

3. Route, assemble, and connect all in-wall piping as desired to and from the shower valve. Make all connections appropriately depending upon the type of pipe that is being used. For copper pipe, soldering will be required and should be completed by a licensed plumber. Apply plumber's tape to any threaded connections if applicable. Install any wood blocking that is necessary to support the piping and valve.

Important Notes:

- A) The valve has a single function outlet on the bottom, and a 3-way diverter on the top of the valve.
- B) One shower function of your choosing can be routed to the bottom valve outlet, while the other three functions will route to the 3-way diverter.
- C) The functions routed to the 3-way diverter will not be able to be used simultaneously, but each can be used in conjunction with the function routed to the bottom outlet.
- D) Female fittings will need to be placed where the body jets will be installed. The fittings should sit no more than $1/4$ " behind the finished wall.
- E) A $1/2$ " NPT pipe nipple will need to be placed where the supply elbow for the hand shower will be installed. The nipple should extend $9/16$ " beyond the finished wall.

SHOWER SET INSTALLATION

4. Once all piping is routed and connections have been made, use the provided ½" test plug to perform a water pressure test. Turn on the main water supply to the home and water test the installed plumbing. Ensure that there are no leaks, then shut the water off. Remove the test plug.

Note: Water pressure testing should be performed by a licensed plumber if you are not familiar with this procedure.

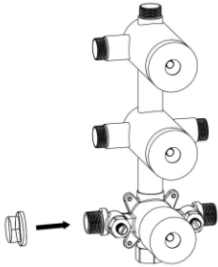

IMPORTANT: COMPLETE THE CONSTRUCTION OF YOUR WALL, INCLUDING ANY FINISHED WALL MATERIALS SUCH AS TILE, BEFORE PROCEEDING WITH THE REMAINDER OF THE INSTALLATION.



Step 2: Trim Installation

1. Once the finished wall is complete, remove the protective sleeves from the valve stems. If the test plug has not yet been removed, remove that as well.

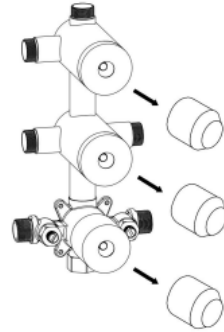

2. Slide the decorative back plate onto the valve. Ensure that the markings located above each opening on the back plate are facing up.

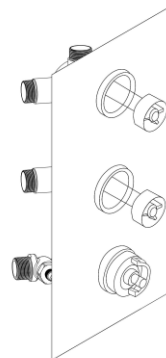

SHOWER SET INSTALLATION

3. Attach the 3-way diverter handle to the top stem by sliding it onto the spindle and tightening the set screw underneath, using the provided hex wrench. Repeat these steps to install the bottom single-function handle.

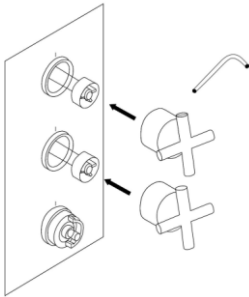

4. To install the temperature control handle, loosen the set screw and remove the handle from the handle base. Attach the handle base to the center stem using the provided screw. Tighten with a Phillip's screwdriver, then reattach the handle.

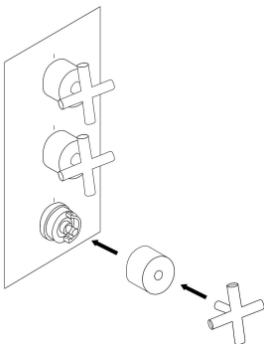

5. To install the hand shower's water supply elbow, thread it onto the prepared 1/2" NPT pipe nipple. Apply thread sealant or plumber's tape to the threads before tightening. Be sure to use the decorative escutcheon to conceal the rough-in.

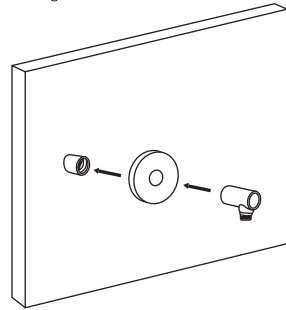

6. Determine a location to mount the hand shower's slide bar. Temporarily install the mounting brackets onto the bar, and hold the bar against the wall at its desired mounting location. Use a level to ensure that the slide bar is straight, then mark the locations of the mounting brackets by outlining them with a pencil. Remove the bar, then attach the brackets to the wall using the provided anchors and screws.

Important: If drilling through tile, you must use a masonry drill bit and drill carefully.

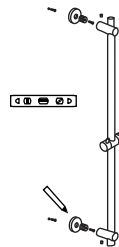

SHOWER SET INSTALLATION

7. Once the mounting brackets are attached to the wall, attach the slide bar by mounting it onto the brackets. To secure, tighten the set screws located on the slide bar using the provided hex wrench.

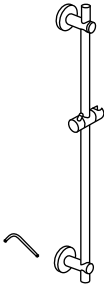

8. Attach the hand shower to the supply elbow using the hand shower hose. Apply thread sealant or plumber's tape to the threads before tightening. Hand tighten the connections firmly.

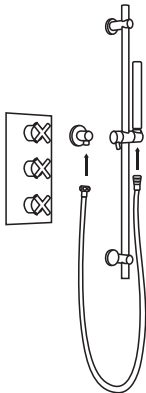

9. Install each of the body jets by threading them into the prepared female fittings. Be sure to use the decorative escutcheons to conceal the rough-ins. Apply thread sealant or plumber's tape to the threads before tightening.

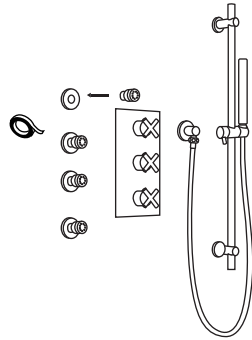

10. Attach the shower arms by threading each of them into their prepared female fittings. Be sure to use the decorative escutcheons to conceal the rough-ins. Apply thread sealant or plumber's tape to the threads before tightening.

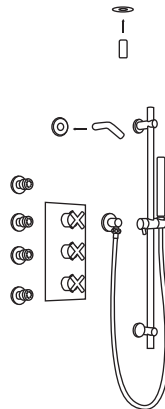

SHOWER SET INSTALLATION

11. Complete the installation by attaching the shower heads to the installed shower arms. Apply thread sealant or plumber's tape to the threads before tightening.

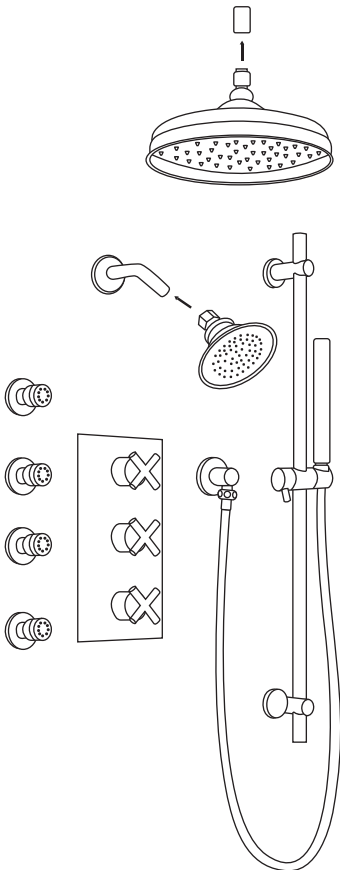

12. Turn the main water supply back on, and test the completed shower system. Ensure that there are no leaks and that all functions are working properly.

