





Hardware List			
LATEL		DESCRIPTION	QTY
D		Connector	4
E		Cap	4
F		Bolt	4
G		Bolt	2
H		Bolt	2
M8		M8 Allen Wrench	1

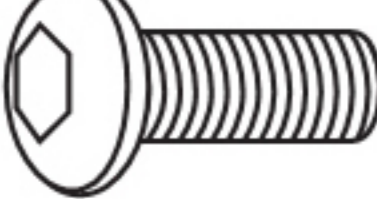
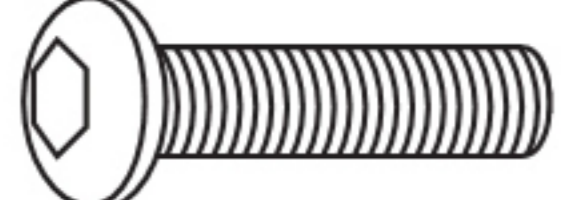

ASSEMBLY INSTRUCTION

Office Chair

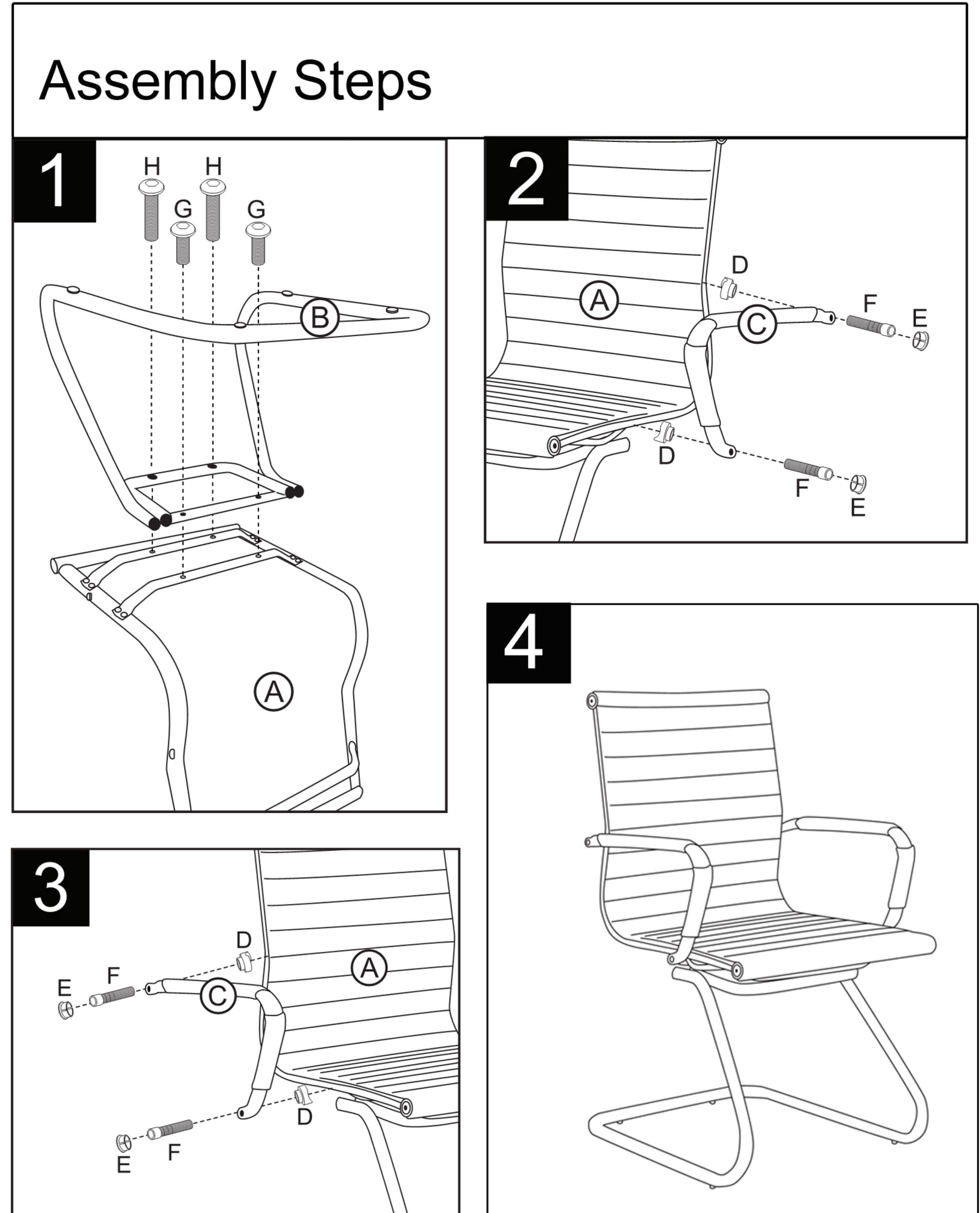
WS-401B

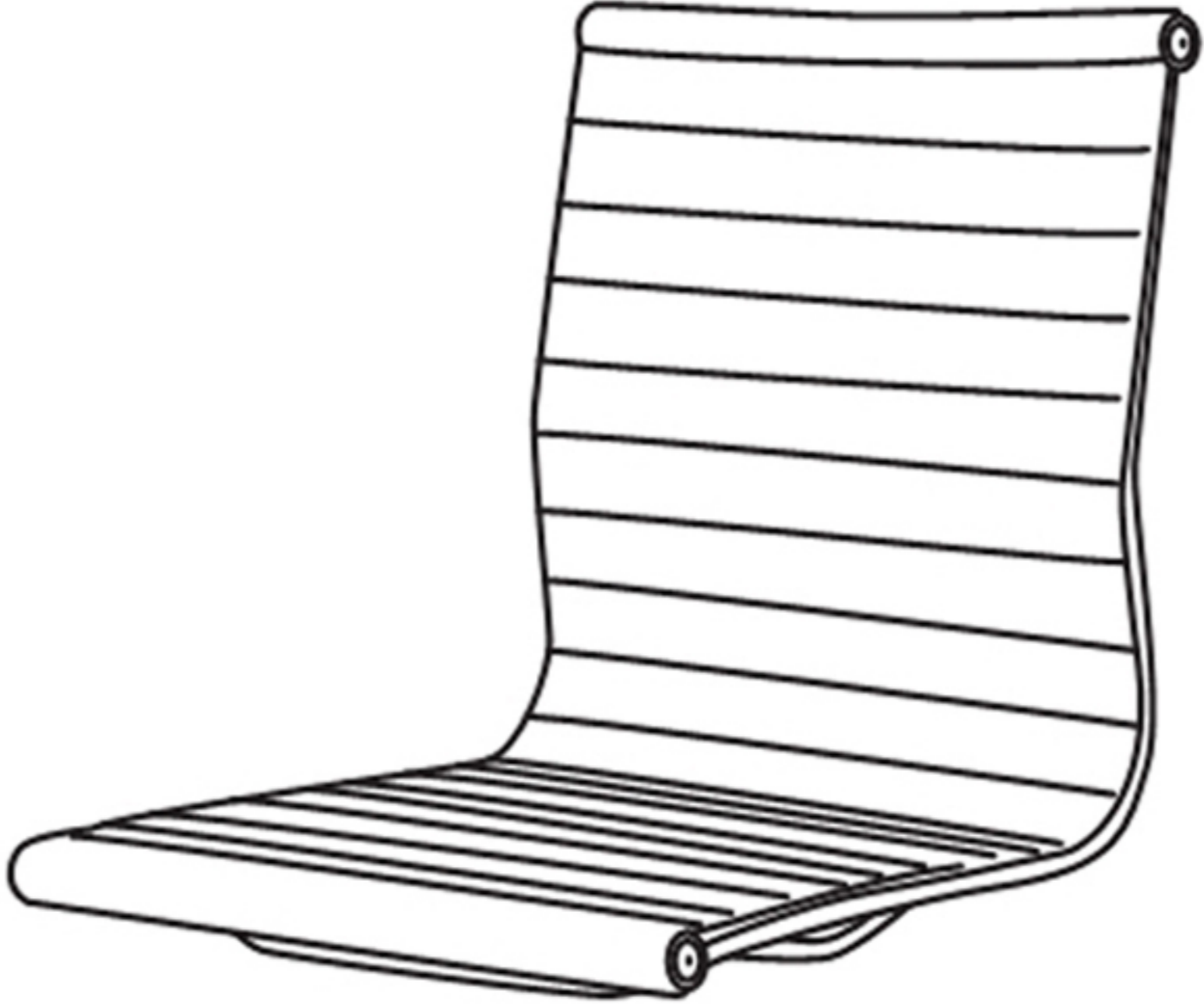
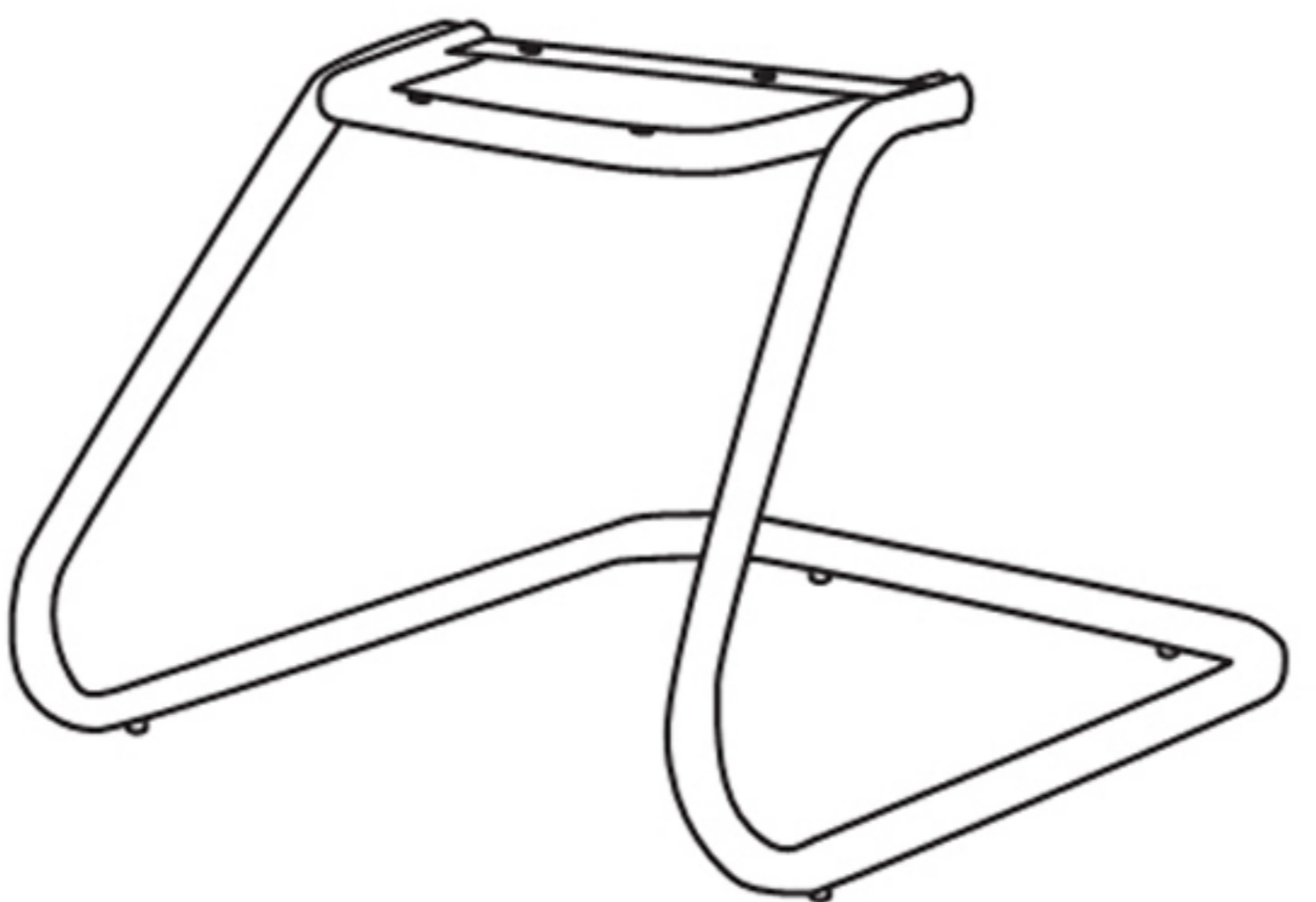
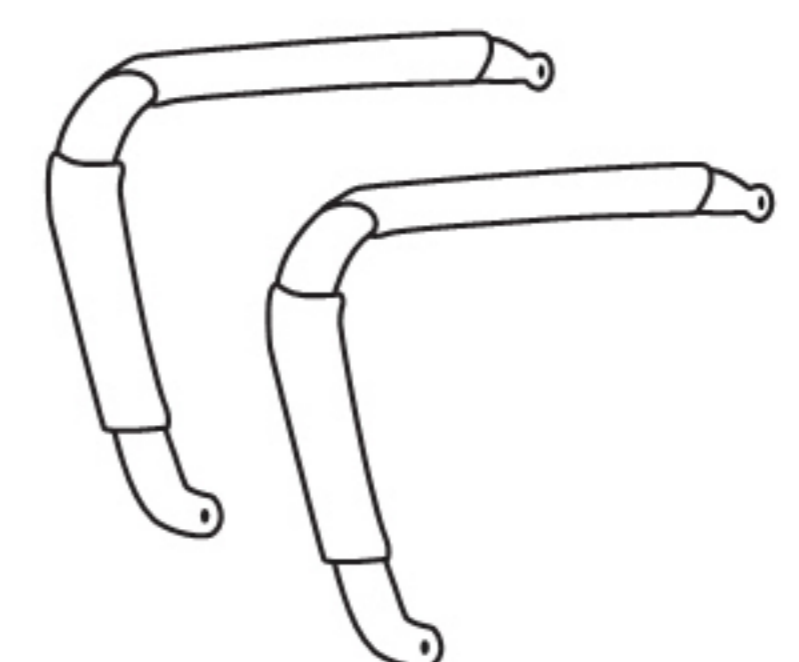

Component List

LABEL		DESCRIPTION	QTY
A		Seat	1
B		Sled Base	1
C		Armrest	2