

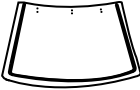







ASSEMBLY INSTRUCTION

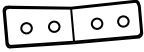





Accent Chair
DY-WX19018-1PC



Component List

LABEL		DESCRIPTION	QTY
A		Chair Back	1
B		Seat	1
C		Cushion	1
D		Connection piece	3
E	 (L)	Leg frame	1
F	 (R)	Leg frame	1
G		The cross	1
H	 (L)	Leg	1
J	 (R)	Leg	1

Hardware List

LABEL		DESCRIPTION	QTY
H1	 M6*25	Bolts	16
H2	 M6*35	Bolts	4
H3	 M6*12	Bolts	4
H4		Flat gasket	4
H5		Flat gasket	12
H6	 5#	Allen Key	1

Assembly Steps

1

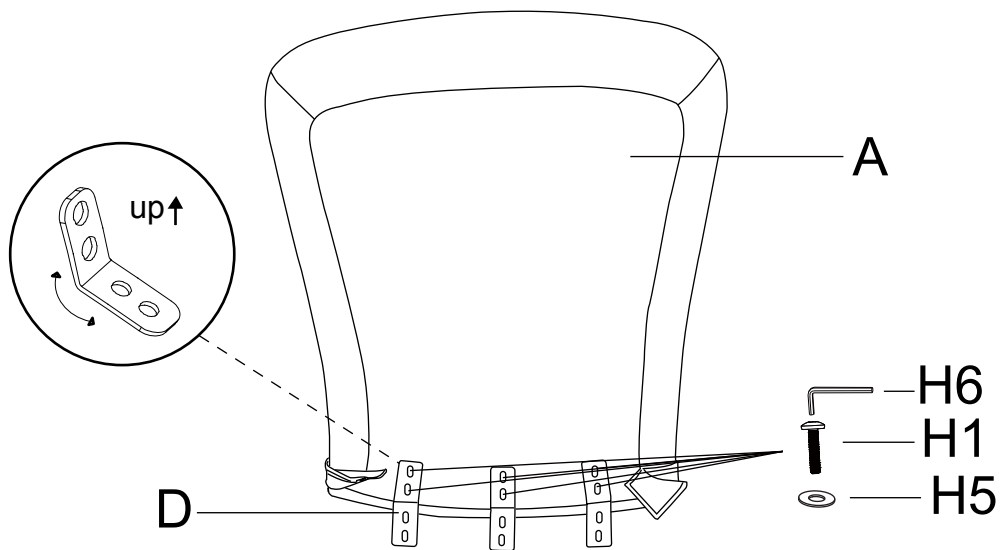

Assemble the metal brackets with back and tighten the bolts.

2

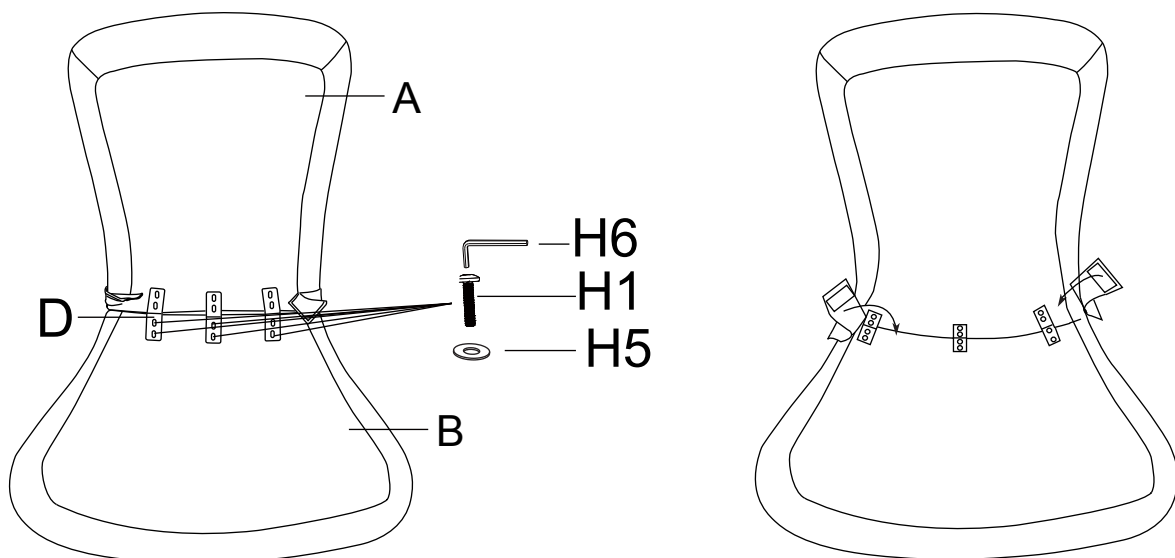

Engage all the bolts, then fully tighten them.

Assembly Steps

3

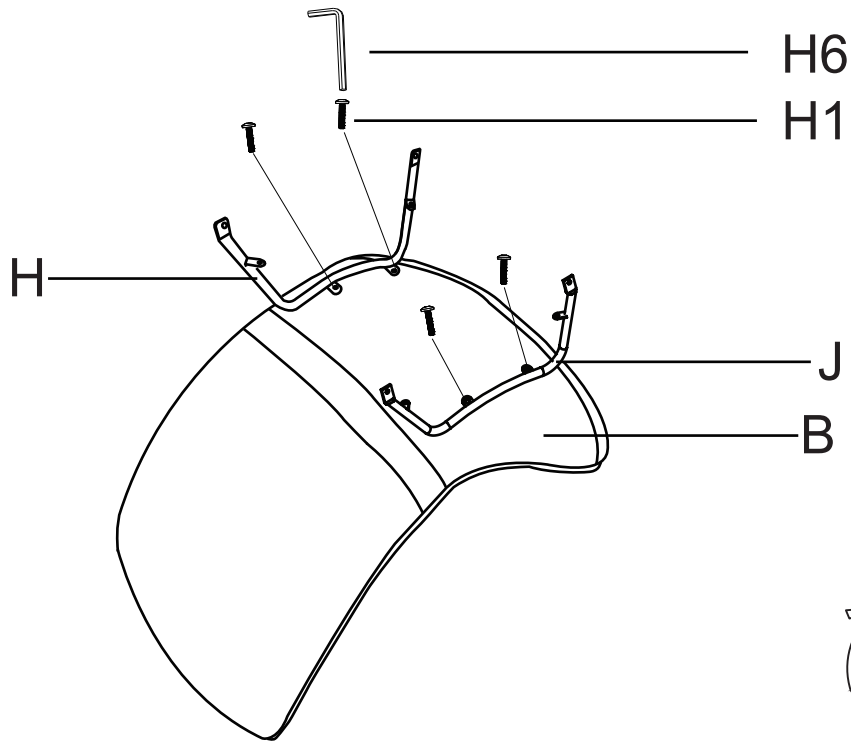

4

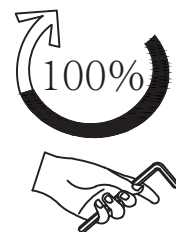
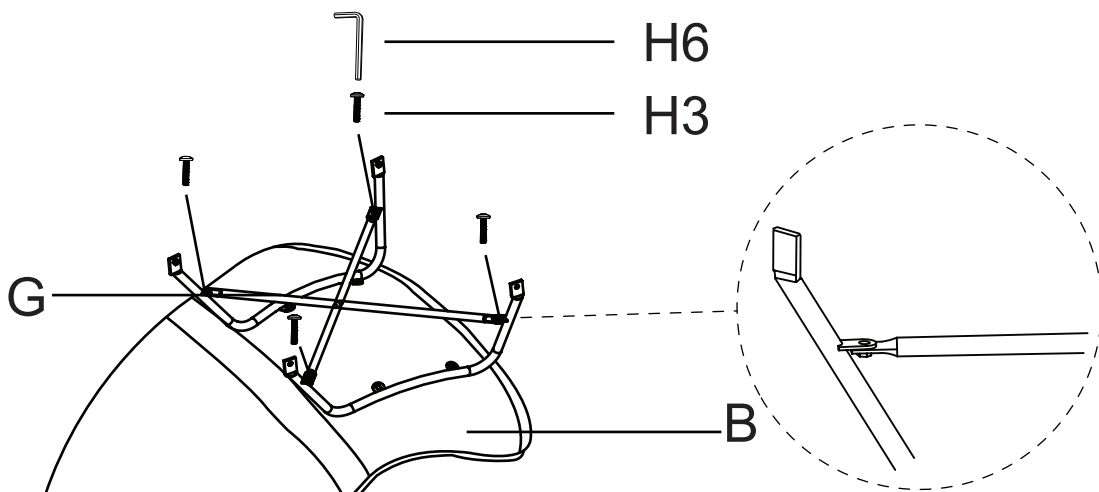

Assembly Steps

5

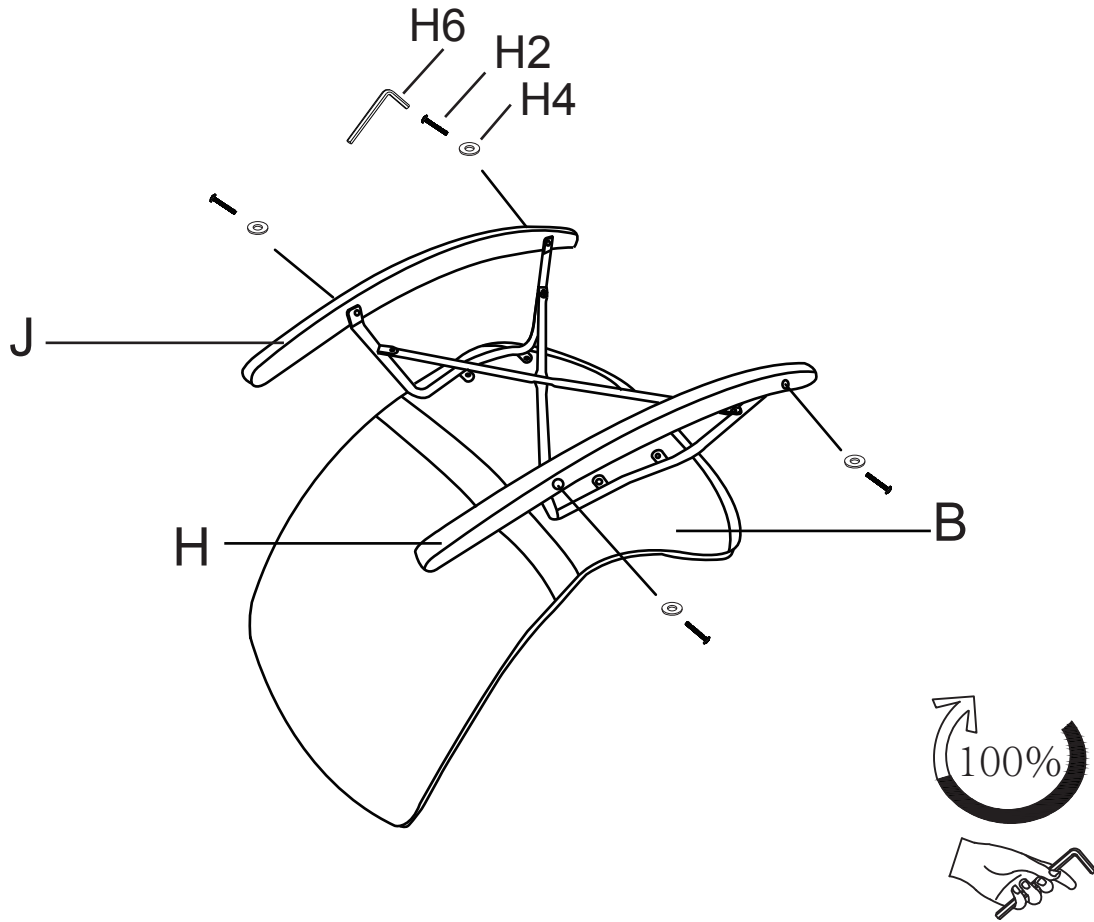

6

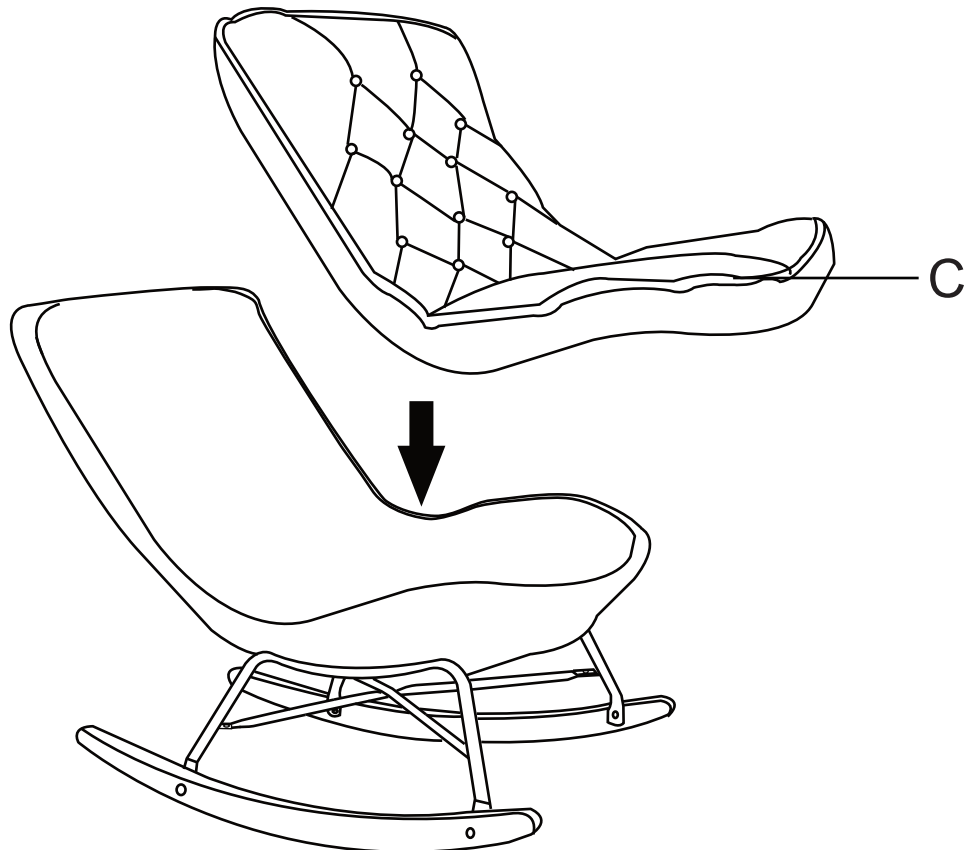

Assembly Steps

