



Originate from TezePower

LiFePO4

12V200AH

(200A BMS)

PRODUCT MANUAL

Lithium Iron Phosphate (LiFePO4) Battery

<https://tezepower.com/>



service@tezepower.com



Shenzhen Teze Power Co.,Ltd.



PRODUCT OVERVIEW

BATTERY

Combination: 12.8V200Ah

Dimension: L20.55*W9.45*H8.58 inch

Plastic Shell Color: Black



TERMINAL & POST BOLTS

Terminal Size:

M8 (1.25mm Metric Thread)

Post Bolts:

M8 (1.25mm Metric Thread*16mm Bolt Length)

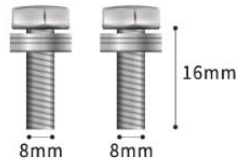

(The bolts can be replaced with M8 bolts of other lengths based on actual needs.)

GENERAL INFORMATION

Operating Voltage	12.8V
Charging Voltage	14.4±0.2V
Max Continuous Load Power	2560W
Max Continuous Charge/ Discharge Current	200A



NOTICE BEFORE USING

Step 1: [CONTACT US](mailto:service@tezepower.com) at service@tezepower.com to activate the FIVE-YEAR WARRANTY

Step 2: [PULL OUT](#) Insulating Plugs

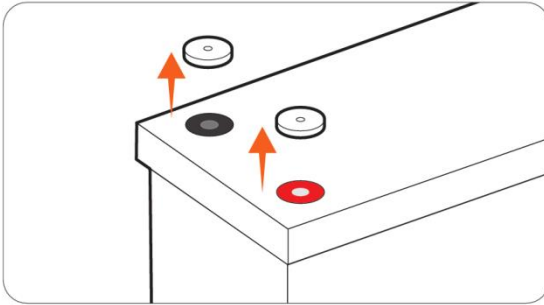

Step 3: [TIGHTLY SCREW IN](#) Post Bolts

⚠ Please tightly screw in the post bolts. Having loose battery terminals will cause the terminals to build up heat resulting in damage to the battery.

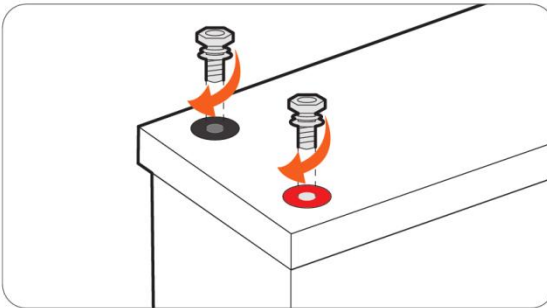

Step 4: [PUT ON](#) Insulating Covers

Please put on the insulating covers to avoid metal or conductive objects touching the positive and negative terminals of the battery at the same time, otherwise it is likely to cause a short circuit.

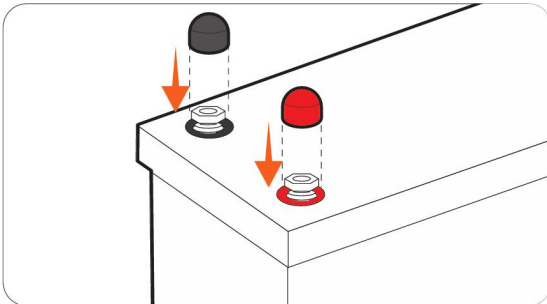



Step 5: TEST The Battery Voltage with Multimeter
≥12V To Step6
<12V Contact us at service@tezepower.com to help solve the problem.

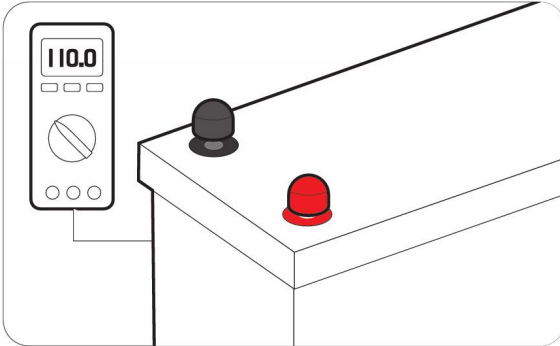

Step 6: FULLY CHARGE The Battery Separately
(Refer to Page 06 for battery charging methods)

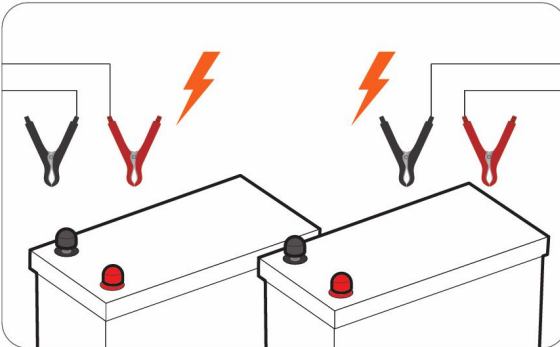

Step 7: CONNECT To Use

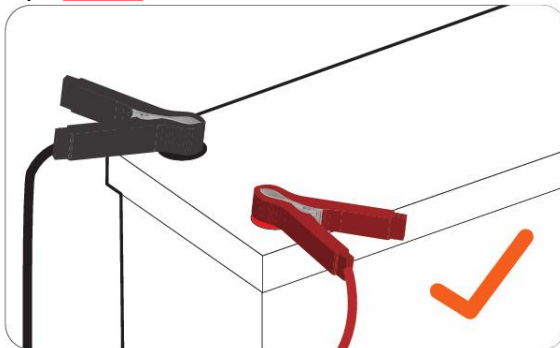



contents

BATTERY- PACK MAIN PARAMETERS	5
APP type battery function	5
Bluetooth module	6
Self -heating module	8
Active equilibrium module (Optional Features)	8
THINGS TO KNOW BEFORE USING	8
CHARGING METHODS	9
THE VOLTAGE WHEN CHARGING & DISCHARGING	9
Battery Charging Logic	10
LiFePO4 Battery Charging Mode	10
SOLAR PANEL(S) & CONTROLLER	10
Solar Panel	10
Controller	10
Controller Settings	11
BATTERY CHARGER	11
ALTERNATOR/GENERATOR	11
HOW TO ESTIMATE THE BATTERY CAPACITY	12
STATE OF CHARGE (SOC)	12
SERIES/PARALLEL CONNECTION	13
THE PREMISE OF CONNECTION	13
LIMITATION FOR SERIES/PARALLEL CONNECTION	13
HOW TO CONNECT BATTERIES	13
Accessory Recommendation	13
Step 1 Wear Insulating Gloves	14
Step 2 Voltage Balancing Before Connection	14
Step 3 Battery-to-Battery Connection	15
Step 4 Rebalancing Every 6 Months	16
Wiring Diagrams	17
INVERTER SETTINGS	19
WHAT TO DO WHEN THE BATTERY STOPS WORKING?	20
ATTENTION	21
WARNING	21



BATTERY-PACK MAIN PARAMETERS

Cell	Prismatic LiFePO4 Battery
Nominal Capacity	200Ah
Usable Capacity	200Ah
Nominal Voltage	12.8V
Energy	2560Wh
Charge Method	CC/CV
Charge Voltage	14.4V±0.2V
Recommend Charge Current	40A(0.2C)
Battery Management System (BMS) Board	200A
Max. Continuous Charge / Discharge Current	200A
Max. Discharge Current 5 Seconds	400A
Max. Continuous Load Power	2560W
Cycle Life	≥4000 times
Internal Impedance	≤40mΩ
Battery Pack Case	Acrylonitrile Butadiene Styrene (ABS) Plastic
Protection Class	IP65
Weight	45.64lb/20.7kg
Dimension	L20.55*W9.45*H8.58 inch
	L522*W240*H218 mm
Temperature Range	Normal-Charge:0℃ to 50℃/32°F to 122°F
	Normal-Discharge:-20℃ to 60℃/-4°F to 140°F
	Self-Heating Charge: -20℃~50℃/-4°F-122°F
	Self-Heating Discharge: -20℃~60℃/-4°F-140°F
	Storage:-10℃ to 50℃/14F to 122°F



APP Type Battery Function (Optional Features)

Bluetooth Module

How to download “Smart BMS” APP

Android:

1. Redirect to download: https://www.dalyelec.cn/daly/SMART_BMS.apk .
2. Redirect to download: <https://www.appgallery.huawei.com/#/app/C102450269> .
3. Scan the QR code download below:



Apple:

1. Redirect to download: <http://apps.apple.com/cn/app/smart-bms/id1519968339> .
2. Search and Download ‘Smart BMS’ APP in Apple Store.
3. Scan the QR code download below:



Smart APP instruction

1. Once you download “Smart BMS” APP, make sure the Bluetooth in function.
2. Be sure the battery has been activated or follow the included product instruction to activate the battery.
3. Click “Smart BMS” APP icon to launch.
4. You can see related Bluetooth series number on the APP interface.
5. Click the Bluetooth series number, direct to an interface with real time parameters of voltage, current, capacity etc.
6. Entering the parameter interface, you will see 5 blocks, including protection, cell, acquisition, temperature and charge/discharge control.
7. To get stable date, non-professional not recommended to make these setting.
8. Professionals need to use initial password 123456 to set up.

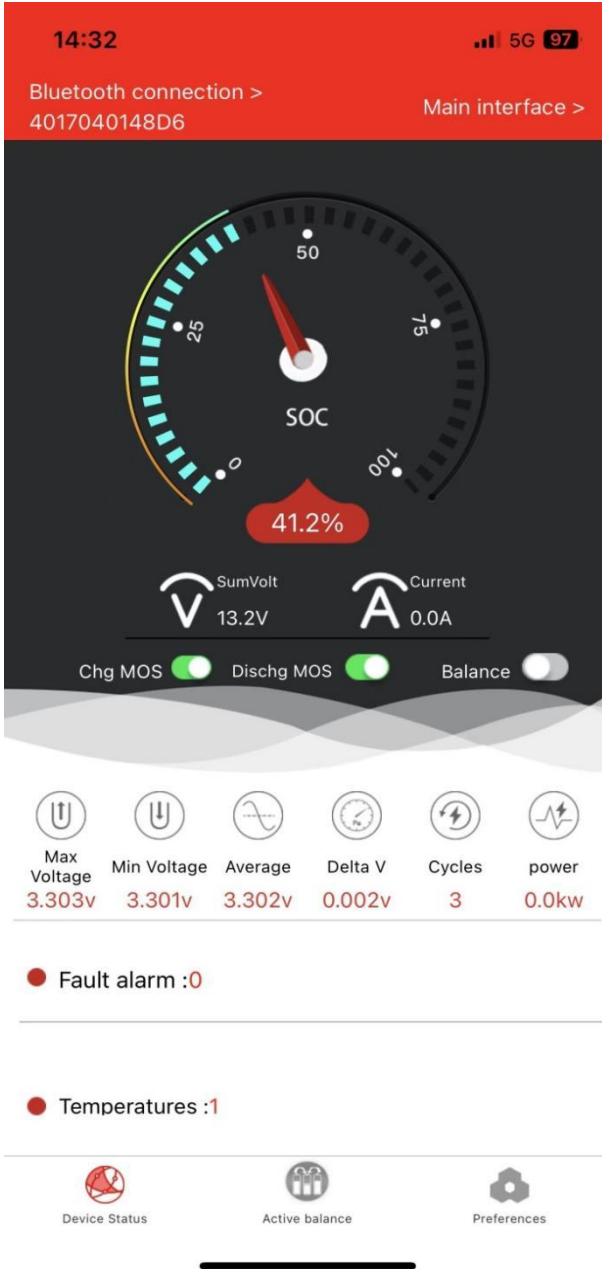



Self-heating Module(Optional Features)

Heating power: Use the charger/battery itself to heat. heating

Logic: Connect the charger.

A. When the ambient temperature is detected to be lower than the set temperature (the customer provides the temperature value), the heating is started and the charge and discharge are disconnected

B. When the ambient temperature is detected higher than the set temperature (the customer provides the temperature value), the heating is disconnected and can be charged and discharged

Heating module: Use a separate heating module. It is used separately from the protective plate, but the heating is controlled by the protective plate.

Active Equilibrium Module

qualification	Data specification
Balance current	0.5~1A
Balance mode	Active equilibrium
Balance on condition	Reach the user-defined opening voltage and differential pressure Minimum voltage of single unit $\geq 3.2V$ (factory default) and equalizing opening differential pressure: $\geq 50mV$ (factory default)
Balance closing condition	Closing voltage and differential pressure reaching the user-defined setting Minimum voltage of single unit $< 3.2V$ (factory default) and equalizing differential pressure: $< 50mV$ (factory default)
Working power consumption	$< 11mA$
Sleep current	300uA
working temperature	$-20^{\circ}C \sim 60^{\circ}C$
Data Monitoring	Bluetooth APP

THINGS TO KNOW BEFORE USING

- Always **put on the insulating covers** on the post bolts to avoid metal or conductive objects touching the positive and negative terminals of the battery at the same time, otherwise it is likely to cause a short circuit.
- **Install the battery upright with post bolt facing up**, and it could not be mounted upside down. If you need to mount the battery at its side, please contact service@tezepower.com to confirm the direction.
- **Tightly screw in the post bolts**. Having loose battery terminals will cause the terminals to build up heat resulting in damage to the battery.
- This battery is not intended to be used to start any devices, please **DO NOT use it as a starting battery**.



➤ Suggestions for **Long-term Storage**:

- Temperature

The battery can be operated at a temperature of -20 °C to 60 °C / -4°F to 140°F, and a temperature between 10 °C to 35 °C / 50°F to 95°F is ideal for long-term storage. Store in a fireproof container and away from children.

- Capacity

For a longer-lasting product, it is best to store your battery at a 50% charge level and recharge every three months if it is not going to be used for a long time.

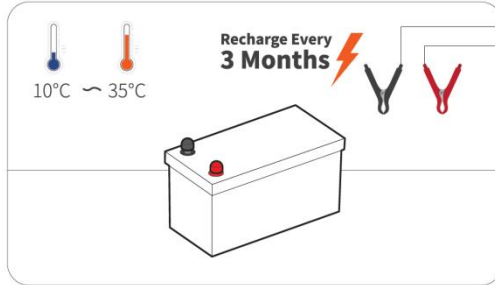

CHARGING METHODS

THE VOLTAGE WHEN CHARGING & DISCHARGING

Based on the characteristics of Lithium Iron Phosphate (LiFePO₄) batteries, the voltage measured by all LiFePO₄ batteries during charging/dis-charging is not the real voltage of the battery.

Therefore, after charging/discharging and disconnecting the battery from the power source, the voltage of the battery will gradually drop/increase to its real voltage.

If you need to test the real voltage of the battery, please disconnect all the connections to the battery and test its voltage after putting it aside for over 30 mins.

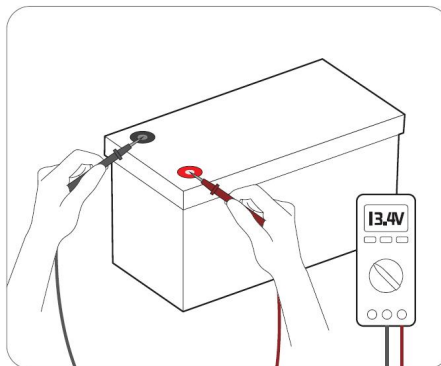

Tips When Testing The Battery Voltage by A Multimeter

① Put the red probe (+) **tightly** on the positive terminal (not the post bolts), and the black probe (-) on the negative terminal.

② Do not touch the metal part of the probes with your hands during use.



Battery Charging Logic

The material characteristics of the LiFePO4 battery determine that its charging curve is obviously different from that of a lead-acid battery. Compared with a lead-acid battery, the LiFePO4 battery has a simpler charging process and mode. Therefore, it is recommended to select LiFePO4 for your charging mode.

If LiFePO4 mode is not available, please refer to the recommended parameters on Page 10 for setting.

LiFePO4 Battery Charging Mode

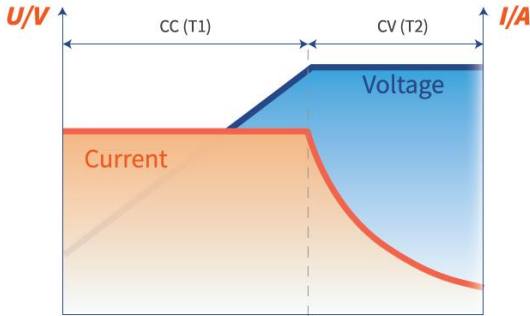

LiFePO4 Battery Charging Curve

- **CC (Constant Current) Phase (T1)**

In the beginning, a discharged battery will be charged with a constant current and voltage will be climbing steadily until reaching the constant voltage setpoint which varies for different charging methods.

- **CV (Constant Voltage) Phase (T2)**

The battery maintains a constant voltage during this phase while the current gradually decreases to 6A (0.02C) which is also known as tail current. At this point, the charging is cut off and the battery is fully charged.

SOLAR PANEL(S) & CONTROLLER

Solar Panel

- Recommend Power: $\geq 900W$
- The battery can be fully charged in one day (with effective sunshine 4.5hrs/day) by 900W solar panels.
- It may take more than one day to fully charge the battery by 900W solar panels since the duration and intensity of light would be a great factor for their charging efficiency.

Controller

➤ Recommend Charging Current:

40A(0.2C)	The battery will be fully charged in around 5hrs to 100% capacity
100A(0.5C)	The battery will be fully charged in around 2hrs to around 97% capacity



- Recommend Charging Mode: 12V (14.6V) LI (LiFePO4)

Controller Settings

Refer to the below parameters if you need to manually set up your controller. As different types of batteries have different charging modes (refer to Page 09), **it is recommended to set only the following parameters for LiFePO4 batteries.** The settings for other types of batteries do not apply to LiFePO4 batteries except for the following settings.

CHARGING	charge/Bulk/Boost Voltage	14.4V/14.6V
	Absorption Voltage	14.4V/14.6V
	Over Voltage Disconnect	15V
	Over Voltage Reconnect	14.2V
	Tail Current	4A(0.02C)
DIS-CHARGING	Under Voltage Warning	11.6V
	Under Voltage Recover	12V
	Low Voltage Disconnect	10.8V
	Low Voltage Reconnect	12.4V

BATTERY CHARGER

Use 14.6V lithium iron phosphate (LiFePO4) battery charger to maximize the capacity.

- **Recommend Charging Voltage:** Between 14.2V to 14.6V
- **Recommend Charging Current:**

40A(0.2C)	The battery will be fully charged in around 5hrs to 100% capacity
100A(0.5C)	The battery will be fully charged in around 2hrs to around 97% capacity

Tips

- ① Connect the charger to the battery before connecting it to the grid power in case of sparks.
- ② It's recommended to disconnect the charger from the battery after fully charging.

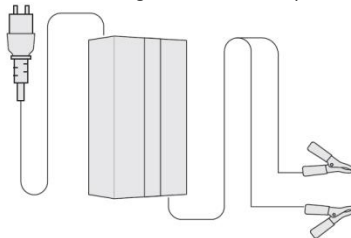

ALTERNATOR/GENERATOR

TEZE battery can be charged by an alternator or generator. If the alternator/generator supports DC output, a DC-to-DC charger needs to be added between the battery and the generator; if the alternator/gen- erator supports AC output, please refer to the recommendations in "Battery Charger" above to add a suitable battery charger between the battery and the generator.



Recommend Charging Voltage: Between 14.2V to 14.6V

Recommend Charging Current:

60A(0.2C)	The battery will be fully charged in around 5hrs to 100% capacity
150A(0.5C)	The battery will be fully charged in around 2hrs to around 97% capacity

HOW TO ESTIMATE THE BATTERY CAPACITY

STATE OF CHARGE (SOC)

The battery capacity could be roughly estimated by its rest voltage (not charging/discharging voltage). As there are subtle differences in the voltage of each battery, the below parameters are for reference only.

Rest Voltage : The voltage needs to be tested at rest (with zero current) after 30 mins of disconnecting from the charger & loads.

CAPACITY	CHARGE VOLTAGE
100%	13.5V
99%	13.4V
90%	13.3V
70%	13.2V
40%	13.1V
30%	13.0V
20%	12.9V
10%	12.8V
1%	10.8V(recommend low voltage disconnect voltage)
0%	9.5V



SERIES/PARALLEL CONNECTION

THE PREMISE OF CONNECTION

To connect in series or/and parallel, batteries should meet the below conditions;

- a. identical batteries with the same battery capacity (Ah) and BMS (A);
- b. from the same brand (as lithium battery from different brands has their special BMS);
- c. purchased in near time (within one month).

LIMITATION FOR SERIES/PARALLEL CONNECTION

Support connecting [up to 16 identical batteries](#) for up to 4 in series as 48V (51.2V) battery system/
4 in parallel as 1200Ah battery system.

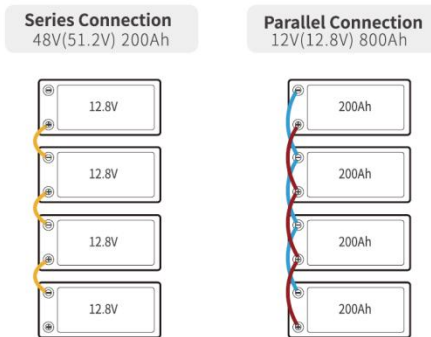

HOW TO CONNECT BATTERIES

Accessory Recommendation

- **Battery-to-Battery Connection Cable:** 2*6AWG Copper Cable
- **Total Input & Output Connection:** Adding two copper bars except for the cables.

Step 1: Refer to Page 14-16 to finish your battery-to-battery connection.

Step 2: Connect all the positive output cables of the batteries to one copper bar.

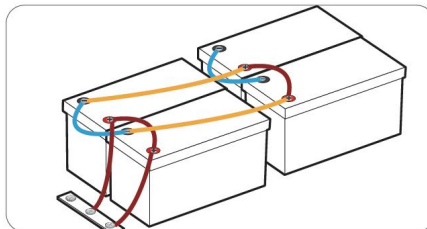

If the positive (+) of the battery is connected to the negative (-) of other batteries (i.e. in series



connection), the + cannot be connected to the copper bar, otherwise the battery system will fail to connect in series.)

Step 3: Connect the **+** of the load to the copper bar.

The cable gauge used in this step should be able to support the total input & output current of the entire battery system.

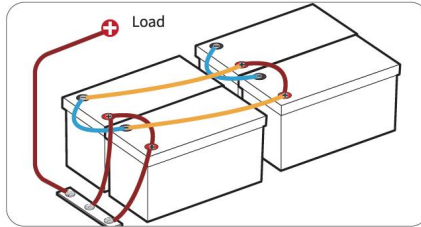

Step 4: The **-** of the battery system and load are also connected to another copper bar following the above steps.

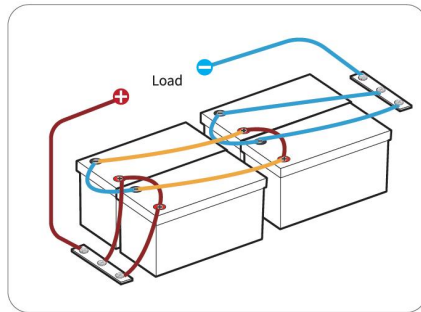

Step 1 Wear Insulating Gloves

Wear Insulating Gloves for protection before connecting. Please pay attention to operation safety in the process of connection.

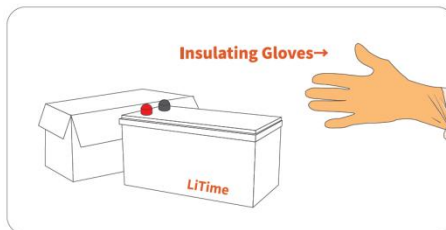

Step 2 Voltage Balancing Before Connection

Below two steps are necessary to reduce the voltage difference between batteries and let the battery system perform the best of it in series or/and in parallel.

- Fully charge the batteries separately (voltage at rest: $\geq 13.4V$)

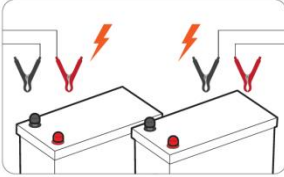

- Connect the batteries one by one in parallel, and leave them together for 12~24 hrs.

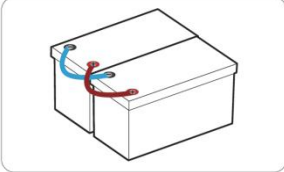

- They can then be connected in series or parallel.

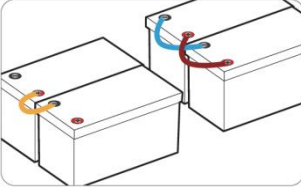

Step 3 Battery-to-Battery Connection

- Connect Batteries in Series **+** to **-**

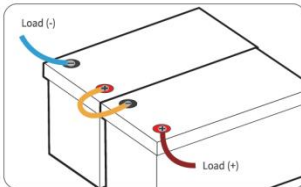

After series connection, the voltage of the battery system will be doubled according to the number of batteries you connect.

E.g. If two 12V 200Ah batteries are connected in series, the battery system will be 24V (25.6V) 200Ah.

- Connect Batteries in Parallel **+** to **+** **-** to **-**

Refer to Page 11 for total input & output connection

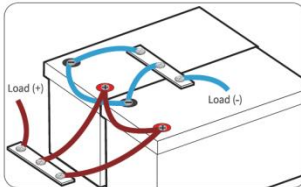

After parallel connection, the capacity of the battery system will be doubled according to the number of batteries you connect.

E.g. If two 12V 200Ah batteries are connected in parallel, the battery system will be 12V (12.8V) 400Ah.



➤ Connect Batteries Both in Series & Parallel
Optimal Connection Method Recommendation

1. Connect the batteries in **parallel**

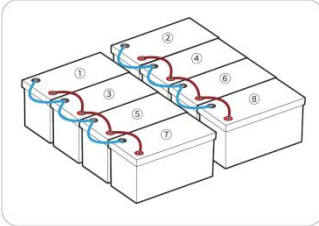

2. Connect the paralleled battery systems in **series**.

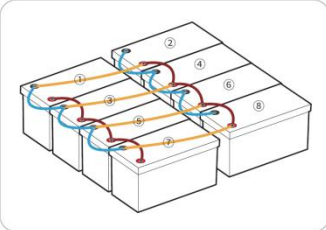

- Connect the positive **+** of battery ①/③/⑤/⑦ to a copper bar and the **+** of the load to the same copper bar. And then connect the negative **-** of ②/④/⑥/⑧ to another copper bar and the **-** of the load to the same copper bar.
Refer to Page16-17 for 2P2S, 2P4S battery system wiring diagram

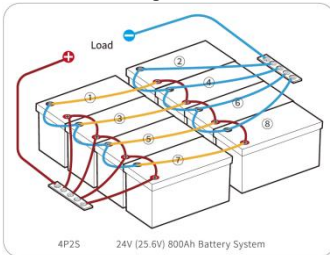

As **-** of ①/③/⑤/⑦ is connected in series with **+** of ②/④/⑥/⑧, please do not connect **-** of ①/③/⑤/⑦ with **-** of load or **+** of ②/④/⑥/⑧ with **+** of load, otherwise the battery system will fail to connect in series.

Step 4 Rebalancing Every 6 Months

It is recommended to rebalance the battery voltage every six months following Step 2 on Page 13 if you're connecting multiple batteries as a battery system, as there might be voltage differences after six months of the battery system running.

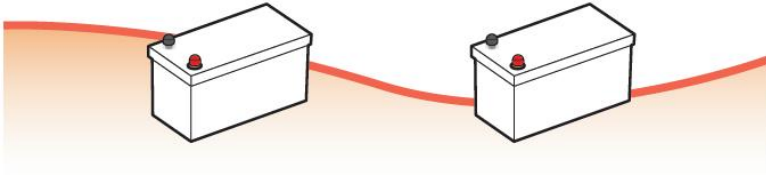

Wiring Diagrams

2S2P	Battery System	24V(25.6V)400Ah
	Energy	10,240Wh
	Max. Continuous Charge / Discharge Current	200A
	Max. Continuous Load Power	5120W

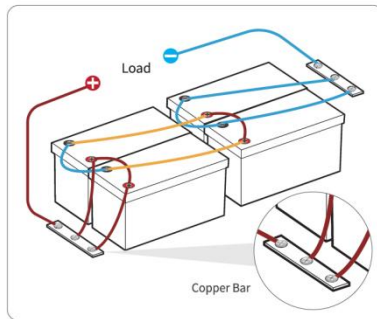

2P4S	Battery System	48V (51.2V)400Ah
	Energy	20,480Wh
	Max. Continuous Charge / Discharge Current	200A
	Max. Continuous Load Power	10,240W

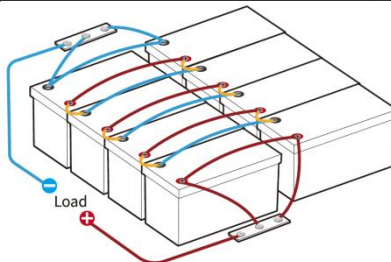



4P2S	Battery System	24V (25.6V)800Ah
	Energy	20,480Wh
	Max. Continuous Charge / Discharge Current	200A
	Max. Continuous Load Power	10,240W

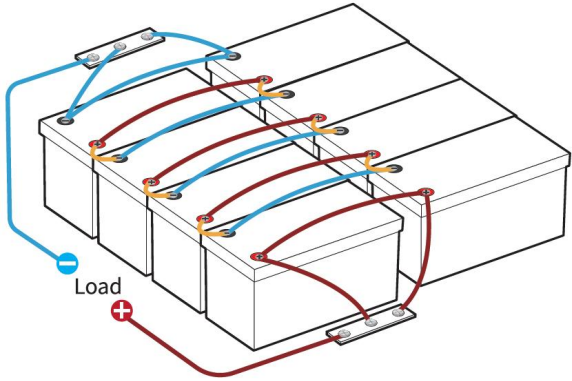



INVERTER SETTINGS

METHOD ONE (RECOMMEND)

Select "12V (14.6V) LI (LiFePQ4) Mode"

METHOD TWO

If method one is not available, select "User Mode" to enter values according to below parameters.

CHARGING	Charge Voltage	14.6V
	Over Voltage Disconnect	15V
	Over Voltage Reconnect	14.2V

DIS-CHARGING	Under Voltage Warning	11.6V
	Under Voltage Recover	12V
	Low Voltage Disconnect	10.8V
	Low Voltage Reconnect	12.4V

The above setting parameters apply to common inverters on the market (such as Victron, Renogy, Growatt, Xantrex, Go Power, Lux Power, etc.). Different brands have slightly different descriptions or naming methods for each parameter. Please directly set the parameters with the same meaning.

If the inverter parameters to be set are special or cannot correspond to one of the above items, please contact service@tezepower.com for confirmation.

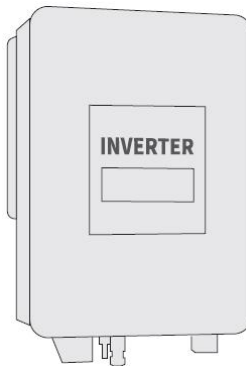



WHAT TO DO WHEN THE BATTERY STOPS WORKING?

When the battery

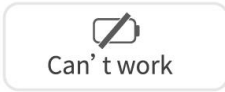

Can't work

or

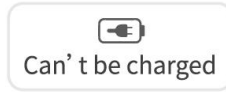

Can't be charged

or



Voltage < 9v

It has 85% chances that BMS has shut it off for protection, and you could try one of below ways to activate the battery.

GENERAL STEPS

If the BMS has cut off the battery for protection, follow the below steps to activate it.

Step 1: **Cut off** all the connections from the battery

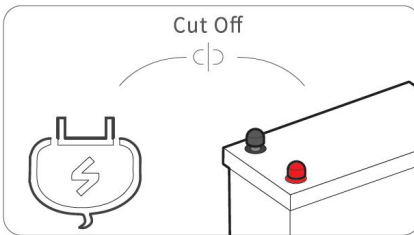

Step 2: **Leave the battery aside for 30mins**

Then the battery will automatically recover itself to normal voltage (>10V) and can be used after fully charged.

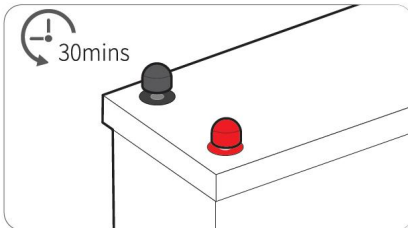

If the battery is unable to recover itself after the above steps, please try activating by **ONE OF BELOW TWO METHODS.**

After activated (voltage>10V) and fully charged by the normal charging method, it can be used normally.

Method ①

Use a **charger with a OV charging function** ① to fully charge the battery

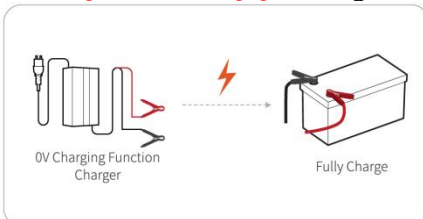



Method ②

Connect an [18V~36V solar panel](#) to charge the battery for 3~10s in sunny daytime.

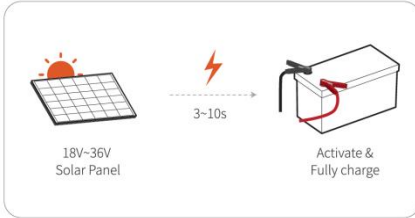

ATTENTION

Caution: Risk of Fire, Explosion or Burns

DO NOT Short circuit

DO NOT Reverse connections from the charger to the battery

DO NOT Disassemble

DO NOT Throw into fire or incinerate

DO NOT Heat above 70 °C /158°F

WARNING

BATTERY DISPOSAL

The electrodes of the waste battery should be wrapped with insulating paper to prevent fire and explosion.

PROHIBITION OF DISASSEMBLY

Never disassemble the cells.

The disassembling may generate an internal short circuit in the cell, which may cause gassing, firing, explosion, or other problems.

The electrolyte is harmful.

Li-Fe battery should not have liquid from electrolyte flowing, but in case the electrolyte comes into contact with the skin, or eyes, physicians shall slush the electrolyte immediately with fresh water and medical advice is to be sought.

PROHIBITION OF DUMPING OF CELLS INTO WATER

Do not soak the battery in which the liquid, like water, seawater and non-alcoholic drinks, fruit juice, coffee or other drinks.

PROHIBITION OF DISASSEMBLY

If any abnormal features of the cells are found such as damages in a plastic envelope of the cell, deformation of the cell package, smelling of an electrolyte, an electrolyte leakage and others, the cells shall never be used anymore.

The cells with a smell of the electrolyte or a leakage shall be placed away from the fire to avoid firing or explosion.

PROHIBITION OF USING IN BELOW PLACES

Do not use the battery in a place with strong static electricity and a strong magnetic field, otherwise, it is easy to damage the battery safety protection device and bring hidden danger.



Originate from TezePower

<https://tezepower.com/> 

<https://tezepower.com/>

 service@tezepower.com

 Shenzhen Teze Power Co.,Ltd.