

Features

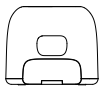

Main Body

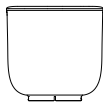

Food Hopper



Food Bowl



Stainless Steel Bowl



Power Adapter



Desiccant



Manual

Desiccant Box

Top Lid

Food Hopper

Body

Stainless Steel Bowl

Food Bowl

Feeding mechanism

Impeller

Food Outlet

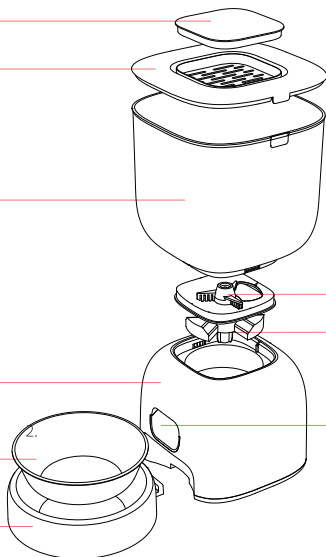

Setup and Assemble Feeder

Lift The Latch

Take out the food hopper and install it by aligning the slot on the base.

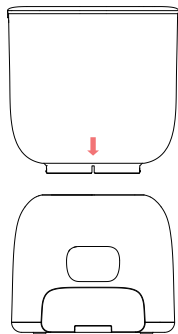

Place Desiccant

Open the desiccant box on top lid, tear off the transparent wrapping paper of the desiccant bag, place it into the box and close it.

Plug in Power Adapter

① Battery power supply: remove the battery cover by releasing the retaining clip, insert 3 good quality alkaline “D” batteries and reinstall the battery cover.

② Power adapter supply: plug in the power adapter and connect the power cable into the card slot.

***Note: Please use safe and standard alkaline batteries. Do not mix batteries of different specifications and models.**

Grain Size Self-check:

Install Food Bowl

Tilt the base unit back slightly, align the buckle of the food bowl with the base unit to install; the same steps to disassemble.

Fill Pet Food

Open the top lid, pour fresh dry food into the food hopper, and close the top lid.

***Note: The device only support 5-12mm dry pet food.**

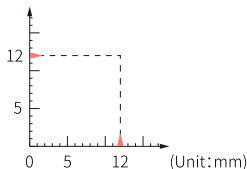

Product Introduction

Unlock The Panel

Long press “⊗” button for 5 seconds to unlock, 30 seconds no operation screen will be automatically locked.

Set Clock

- ①Unlock the panel, Press “⊗” button to enter setting.
- ②Set Clock: Press “+” or “-” to adjust hours, Press “⊗” button to confirm. Press “+” or “-” to adjust minutes Press “⊗” button to confirm.

Program Feeding Schedule

- ①Program Meal Time: “1” icon flash means setting the first meal, Press “+” or “-” to adjust hours and minutes, Press “⊗” button to confirm.
- ②Meal Size: LCD display goes into meal size set mode after setting the meal time “🗄” icon illuminate, Press “+” or “-” to select desired, Press “⊗” button to confirm.
- ③Repeat this process for as meal times portions desired (Up to 4 meals and 9 portions).
- ④If you do not need to set too much feeding schedule, long press the “⊗” button to save and exit the set mode.

Check the feeding schedule



In the locked state, press “+” or “-” to check the 1-4 meal feeding schedule, but it cannot be set.

Manual Feed

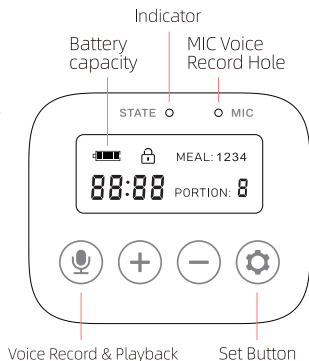
Unlock the panel, long press “+” button to feed one.



Record

Unlock the panel, long press “” to enter recording mode, the “STATE” indicator light is on and record voice toward the “MIC” hole for up to 10 seconds. If the “” button is released within 10 seconds, the recording ends immediately.

**Note: If you need to record again, repeat the above steps.*



Play Record

Unlock the panel, press “” to play record once, no play if no record.

Cancel Feeding Schedule

Set the portion to be “PORTION: ”, then no feed anymore.





Default Meal Settings

Unlock the panel and press the “” and “” simultaneously until heard “DiDi” sound, which reset the time and clears the feeding schedule and recording.

Indicator Information

STATE ○	ON	Working
STATE ●	ON	Voice Recording
	Flash	Device Faulty
		Low Battery Power

LCD Screen Icons Information

	OFF	Battery Uninstalled
	ON	With Battery Inside
	ON	Low Battery Power
	ON	Panel Unlock
	ON	Panel Lock
MEAL: 1234	OFF	Meal OFF
	ON	Meal ON
	FLASH	Meal Setting

Disassemble & Clean

Power Off

Unplug and take out the alkaline batteries.

Clean

- ① Hold the fuselage steady and pull out the food hopper upward.
- ② Disassemble the impeller and feeding mechanism.
- ③ The main body of the feeder is not dishwasher-safe. Do not immerse the main body in water. This could damage the internal electronics and cause the batteries to short out, create an electrical shock, or catch fire.
- ④ Use the dry soft cloth to wipe it, the body is not waterproof, please do not use wet cloth.
- ⑤ Make sure all parts of the feeder are completely clean and dry before filling with food.

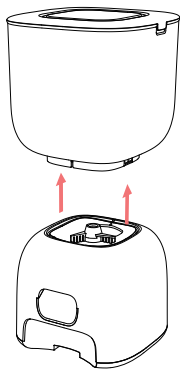

Assemble

- ① Align the triangle mark when installing the impeller.
- ② Install the food hopper by aligning the slot on the base.

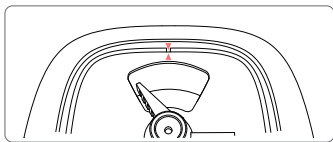

Replace the desiccant pack

Open the desiccant box cover and replace the desiccant. It is suggested to replace it every one months.

Replace Alkaline Batteries

Unplug and open battery lid at the bottom, then you can replace the batteries

*Warnings:

- ① Please keep the food hopper dry after cleaning it.
- ② Please replace the food on a regular basis if your pets did not eat up.
- ③ Please clean and maintenance your device on a regular basis to prolong the using period of your pet feeder.

故障排除

What happened to your device	How to check by yourself	How to solve it
No display on LCD Screen	Not plug or battery inside	Plug in or install batteries
	Feeder faulty	Contact After-sale service
Impeller can not be installed	Food blocked on the installation position	Clear the cat food inside the installation position, align the triangle and reinstall
Food hopper can not be installed	Food blocked on the installation position	Clear the cat food inside the installation position and reinstall
E1 -- Display	Impurities inside food hopper	Clean the impurities inside of food hopper
	Food size inapplicable	Ensure to use 5-12mm dry food

Parameters

Product Name	F14-L Automatic Pet Feeder
Product Model	F14-L
Dimension	168mm*296mm*290mm
Material	Food-grade ABS、SUS 304 Stainless Steel Bowl
NW	Around 1.0KG
Capacity	3.0L
Food Appliance	5~12mm Dry Food
Pets Appliance	Cats & Small size dogs
Power	DC 5V1A Adapter / 3 * D Size Batteries
Rated Power	0.5W

Safety Precautions

Read all instructions carefully before attempting to operate this device.

🕒 Keep Device

1. For indoor use ONLY.
2. Device need to be placed horizontally and firmly, it's not allowed to tipped one side and rock or upside down.
3. Keep device placed in a dry area and not expose the device under sunlight.
4. Not to place the feeder in a high place to avoid the damage from dropping.
5. DO NOT place any foreign objects in the feeder.
6. To avoid tripping, always keep power cord out of the way of foot traffic.
7. Do not place anything on top of this feeder.
8. Ensure there is no barriers near the food outlet to make the pets can be fed normally.

🔌 Electricity safety

1. Please check the power supply before going out.
2. The clock will be maintained for a year if the device is powered off.
3. Please pay attention to the battery display when powered by batteries, users need to replace the batteries when “” shows on LCD screen.
4. It's suggested to replace the batteries once a year if you do not get the device work by batteries, for the power will be running off with time goes by.
5. When powered by batteries, it is normal for the electric quantity icon to fluctuate occasionally because of the large transient current.
6. To prevent electric shock, do not insert the power cord or plug into water or other liquids.
7. The device only supports the use of a 5V/1A adapter; please do not use a non-specific adapter.

⚠️ Caution

1. Intended for use with dogs or cats ONLY.
2. DO NOT use this feeder with puppies, kittens, dogs or cats with any physical disability.
3. NOT recommended for puppies or kittens less than 7 months old or unable to reach the feeding dish.
4. DO NOT allow small children to play with, in or around feeder.
5. DO NOT eat the desiccant. DO NOT use it if it is damaged.
6. For dry food use ONLY. Works best with 5-12mm food diameter or smaller.
7. DO NOT attempt any repairs or modifications to the feeder.
8. DO NOT immerse the feeder in water at any time, as this can cause damage to the electronic components.
9. Dispose of all packaging material properly. Some items may be packed in oily bags; these bags could cause suffocation; keep away from both children and pets.
10. Check with your veterinarian if you are unsure about the proper MEAL SIZE for your pet.
11. DO NOT operate feeder without Bowl, Food Hopper and Lid securely in place.

User Manual

Automatic Pet Feeder

F14-L

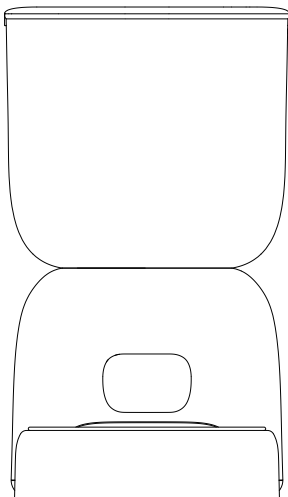

Please read the manual carefully before using this product.