

# **MK15**

## **MINI HANDHELD GROUND STATION USER MANUAL**



**V1.11**

**July 2021**

Thank you for purchasing SIYI Technology's product.

MK15 is a 15-kilometer range Android smart controller with dual 1080p FPV, based on the full high-definition image transmission technology, which is completely and independently developed by SIYI Technology. The system is deeply optimized and integrated with Qualcomm 8-core CPU platform. MK15's abundant features and powerful performance make it a commonly applied device of reliable image transmission and solid control on agriculture drones, commercial drones, unmanned vehicles, and boats, and robotics.

To maintain a safe and orderly public space and to ensure you a good using experience of MK15 mini handheld ground station, please read this manual carefully. If you have any issue using the product, please consult the manual or check online pages of MK15 on SIYI Technology's official website (<http://www.siyi.biz>). You can also send an email to SIYI official A/S center ([support@siyi.biz](mailto:support@siyi.biz)).

## SIYI User Group - Facebook



**SIYI YouTube Channel** (<https://www.youtube.com/channel/UC0vdyQDSRr3fiCffNKnYimA>)

**SIYI Official AliExpress Store** ([https://www.aliexpress.com/store/911142095?spm=a2g0o.store\\_home.1000001.11.22595727131Low](https://www.aliexpress.com/store/911142095?spm=a2g0o.store_home.1000001.11.22595727131Low))

## CONTENT

READ TIPS .....	1
Icons.....	1
Safety.....	1
Battery .....	3
Memory Card (SD/TF).....	3
How to Use SIM Card on MK15 .....	4
Storage/Carrying/Recycling.....	5
1 INTRODUCTION .....	6
1.1 Product Features.....	6
1.2 Parts .....	9
1.2.1 At a Glance .....	9
1.2.2 Button/Switch Types and Default Channel Definitions.....	11
1.2.3 Ports on MK15 Transmitter.....	12
1.2.4 Ports on MK15 Receiver .....	14
1.3 Technical Specification.....	14
1.4 Packing List.....	17
1.5 MK15 Common Diagram.....	19
1.6 MK15 Dual Remote Combo Diagram.....	21
1.7 Indicator Definition .....	22
1.7.1 Transmitter Indicator.....	23
1.7.2 Receiver Indicator .....	24
2 GET READY TO USE MK15 .....	25
2.1 Transmitter .....	25
2.1.1 Power On/Off .....	25
2.1.2 Charging.....	26
2.1.3 Charging Indicator.....	26
2.2 How to Place MK15 Antennas.....	27
2.2.1 How to Place Transmitter Antenna .....	27
2.2.2 How to Place Receiver Antenna.....	28
3 SIYI TX APP .....	30
3.1 Channels.....	31

3.1.1 End Point.....	31
3.1.2 Middle Point .....	32
3.1.3 Channel Reverse .....	33
3.1.4 Channel Mapping.....	33
3.2 Datalink .....	34
3.2.1 Connection .....	35
3.2.2 Flight Controller .....	36
3.2.3 Baud Rate .....	36
3.3 System .....	37
3.3.1 Bind .....	38
3.3.2 Frequency Self-Adapting .....	38
3.3.3 Throttle Type.....	39
3.3.4 Production Date.....	39
3.4 Status .....	39
3.5 Failsafe .....	40
3.6 Buttons / Dials.....	43
3.6.1 Buttons.....	43
3.6.2 Dials .....	44
3.7 Joystick Calibration .....	45
3.8 Dial Calibration .....	47
3.9 Multiple Links .....	50
3.9.1 RC Relay .....	51
3.9.2 Dual RC .....	52
4 DATALINKS.....	55
4.1 Communication with GCS through USB COM (Serial).....	55
4.2 Communication with GCS via Bluetooth.....	57
4.3 Communication with GCS through UDP.....	59
4.4 Solutions to Disconnection .....	60
5 SIYI FPV APP .....	62
5.1 Settings.....	62
5.2 Link Status.....	63
5.3 About SIYI FPV.....	63

6 IMAGE TRANSMISSION .....	65
6.1 Using SIYI IP Cameras .....	65
6.2 Using Third-Party IP Cameras / Pods.....	65
6.3 Using HDMI Cameras / Pods .....	66
6.4 Dual Video Stream Connection.....	67
6.4.1 Dual SIYI IP Cameras .....	67
6.4.2 Dual Third-Party IP Cameras .....	67
6.4.3 SIYI HDMI Converter and SIYI IP Camera .....	68
6.4.4 SIYI HDMI Converter and Third-Party IP Camera.....	68
6.4.5 Dual SIYI HDMI Converter .....	68
6.5 Common IP Addresses .....	69
6.6 Solutions to No Image .....	70
6.7 Output Transmitter Image Display to Other Device .....	71
6.7.1 Through Transmitter HDMI Port .....	71
6.7.2 Through WiFi Hotspot .....	72
7 ANDROID OS.....	74
7.1 Download App.....	74
7.2 Import and Install App.....	74
7.2.1 Through TF Card.....	74
7.2.2 Through USB Drive.....	75
8 Firmware Upgrade.....	76
9 After-sale Service .....	78
9.1 Repair Service .....	78
9.2 Warranty .....	79
9.2.1 7-Day Return & Refund.....	79
9.2.2 15-Day Replacement.....	80
9.2.3 1-Year Warranty Repair .....	82
10 FCC STATEMENT .....	84

## READ TIPS

### Icons

Please pay more attention to content indicated with the following marks:

 **DANGER** Dangerous manipulation probably leads to human injuries.

 **WARNING** Warnings on manipulation possibly leads to human injuries.

 **CAUTION** Cautions on what manipulation may lead to property loss.

 **Prohibited**  **Mandatory**  **Mark**

### Safety

MK15 Mini Handheld Ground Station is designed for professional application in specific industries, users who approaches to the device should have at least the basic knowledge to operate it. Irregular or irresponsible manipulations to the device may cause damage, property loss, or human injuries. Users under 14 years' old should follow an experienced trainer's guide. Disassembling or modification to the system is prohibited without permission from its manufacturer, SIYI Technology.

To maintain a safe and orderly public space and to ensure you a good using experience of SIYI's products, please read the prohibited and mandatory terms carefully.

 Do not use any SIYI radio system to operate your aircraft/vehicle/model at places with intensive crowd (a square, a park), or at places with many obstructions (a street, a parking lot), or in fields with strong magnetic or interference (an electricity plant, a radar station, railways), or in any other fields where an irregular flight/operation may cause property loss or human injuries.

 Do not hold or cover transmitter antenna or obstruct its transmission by any means in a flight or an operation.

 Never point your transmitter antenna's upper ends straightly to your aircraft/vehicle while it is working, they are the weakest parts for transmission.

 Do not start your aircraft/vehicle/model when you are tired, drunk, in sickness or any circumstances you are not feeling good.

 Do not fly an aircraft/model when it is rainy, windy or at night.

 Do not power off the transmitter while your aircraft's/vehicle's/model's engines and motors are still working.

 Please always try to operate your aircraft/vehicle/model within sight range.

 Do not forget to check battery level of the transmitter and the receiver before starting your aircraft/vehicle/model.

 Always power off your aircraft/vehicle/model first, FT24 transmitter the second.

 Before changing any settings on the transmitter, make sure your aircraft's/vehicle's/model's engines are powered off and their motor wires are off connection, in case of a sudden switch-on.





 When you start your aircraft/vehicle for the first time, make sure that the fail-safe settings in your transmitter is activated.

 Always switch on the transmitter first and hold the throttle joystick at its bottom position, then power on your aircraft/vehicle/model.

## Battery

MK15 transmitter is equipped with a built-in and chargeable 10200mAh Li-on battery and a 20W PD fast charger. Please do read the precautions before using and charging MK15 battery.

 Please power off MK15 transmitter before charging. The transmitter does not allow charging while it is working.



 Stop charging immediately if you found the charger damaged, broken or overheat.

 Stop charging immediately if there was a peculiar smell, smokes or leaks. In such cases you shall sent the transmitter back to your dealer for after-sales service.

 Do not charge the transmitter when temperature is high, or battery temperature is over 60°C.

## Memory Card (SD/TF)

The memory card slot at bottom MK15 transmitter supports reading from and writing into high-speed SD/TF card. Please mind the precautions below.

-  Do not disassemble, bend, press, abandon or damage memory card by any means.
-  Stop using the memory card if you find it soaked by water, oil or any other chemical liquid.

## **CAUTION**

A memory card is also an electronic product, keep it away from static electricity.

Keep the memory card slot clean in case of blocking by sand or dirt.

Keep the memory card in slot while you are downloading or uploading data; taking out it mistakenly, hitting it or shattering it may cause damage or data loss.

Keep the memory card away from places that a baby or a kid may reach in case that it was swallowed mistakenly by the baby/kid.

## **How to Use SIM Card on MK15**

MK15 supports 4G network, like a smartphone. You can put in an SIM card into the transmitter to activate the function.

Before putting in an SIM card into MK15 transmitter, please check if it supports your local cellular network.

## **Supported Format and Frequency Bands**

GSM/EGRPS 4 Frequency: EGSM900/DCS1800

WCDMA: B1/B8

LTE FDD: B1/B3/B5/B7/B8

LTE TDD: B34/B38/B39/B40/B41

EVDO/CDMA: BC0



## **CAUTION**

MK15 4G function is not certified. Please refer to your local radio laws or wireless regulations before activating 4G network.

## **Storage/Carrying/Recycling**

When your SIYI radio system is stand idle, or you are bringing it outdoors, or the system reached service life, then please do read the precautions below.



## **CAUTION**

Always place your MK15 transmitter at places where babies or kids do not reach.



## **DANGER**

MK15 transmitter should be placed as below:

Not too hot (above 60°C) or too cold (under -20°C).

Not under direct sunshine or too dusty or too wet.

Not on an unstable holder which lacks solid supports or may cause vibration.

Not nearby steam or other heat sources.

# 1 INTRODUCTION

## 1.1 Product Features

### 15KM 1080P Image Transmission

Once again SIYI made a breakthrough, applying this brand new and cutting edge high-definition image transmission technology on MK15 successfully. The technology comes with a smart ability to adapt its transmission to better frequency bands, which means it always goes to work on the band with least interference. With the standard omni directional antennas, MK15 system's effective range can reach up to 15 kilometers. With the long-range antennas coming with MK15 enterprise combos, the range can be up to 30 kilometers with full HD image transmission, real-time telemetry, and stable control.

### Dual Full HD Low-Latency Video Stream Display

MK15 receiver supports standard RTSP video stream input through its standard ethernet port directly or converted by HDMI module. The stream is up to two-way 1080p video simultaneously, latency low to \*180ms. The pre-installed SIYI FPV application supports switching display of two video streams between the main screen and the floating window, and the video stream SDK is fully open to developers. On agriculture drones, the feature works with front camera and back camera for almost 360-degree visual protection. On commercial drones, the two-way video stream makes it ultimately possible for integrating optical camera and

thermal imaging camera through one link.

*\*The 180ms latency is an average result measured by using SIYI standard IP camera under the following conditions:*

*H.265 format, 720p @ 30 fps, displayed in QGC v4.1 (low-latency mode): end-to-end latency is between 130 and 180ms.*

*H.265 format, 1080p @ 30 fps, displayed in QGC v4.1 (low-latency mode): end-to-end latency is between 180 and 250ms.*

## **Superior Performance**

MK15 transmitter carries Qualcomm Snapdragon 8-core CPU, which can decode 1080p @ 60fps video stream by hardware in both H.264 and H.265 format. The CPU's powerful computational performance lowers image transmission and display latency to 180ms. \*Transmitters coming with MK15 enterprise combos are equipped with standard HDMI port for outputting video stream to an external monitor. It also supports 4G network, after secondary development the video stream can be pushed to cloud network.

*\*Transmitters coming with MK15 agriculture combos do not support HDMI output.*

## **1000 cd/m2 High Brightness, 1920\*1080 High-Definition Monitor**

MK15 has a 5.5-inch high-definition and high-brightness LCD screen. Display definition is 1920\*1080 pixels. Max brightness is 1000cd/m2, which is almost two times of usual smartphones, crystal clear under direct sunshine.

## **Dual Remote Controller**

## **Remote Control Relay**

## **Multiple Wireless Features**

Wireless Binding

*Coming soon*

*OTA Receiver Upgrade*

## **Super Long Battery Life, 30W PD Fast Charging**

With high-capacity built-in li-on batteries with great performance, MK15 transmitter's battery life is up to 12 hours. The batteries' stable and efficient discharging curve secures the system when running in high speed. \*MK15 transmitter supports max 30W PD fast charging, which can charge 95% battery level in three hours.

*\*The standard charger coming with all MK15 combos is PD 20W. The PD 30W charger is optional.*

## 1.2 Parts

### 1.2.1 At a Glance



Overview – Transmitter Front



Overview – Transmitter Back



## 1.2.2 Button/Switch Types and Default Channel Definitions

MK15 transmitter owes 13 physical channels and 16 communicational channels in total. Communicational channel 10 to 14 are mapped with PWM 1 to 5 in default.

Channel No.	Physical Channel Type	Default Mapping	Remark
1	Aileron	Joystick J1	
2	Elevator (Mode 2)	Joystick J2	
3	Throttle (Mode 2)	Joystick J3	
4	Rudder	Joystick J4	
5		3-Stage Switch SA	
6		3-Stage Switch SB	
7		3-Stage Switch SC	
8	Camera LED	Button A	
9		Button B	
10		Button C	PWM 1
11		Button D	PWM 2
12		Left Dial LD	PWM 3
13		Right Dial LD	PWM 4
14			PWM 5
15			Searchlight A
16			Searchlight B

### 1.2.3 Ports on MK15 Transmitter

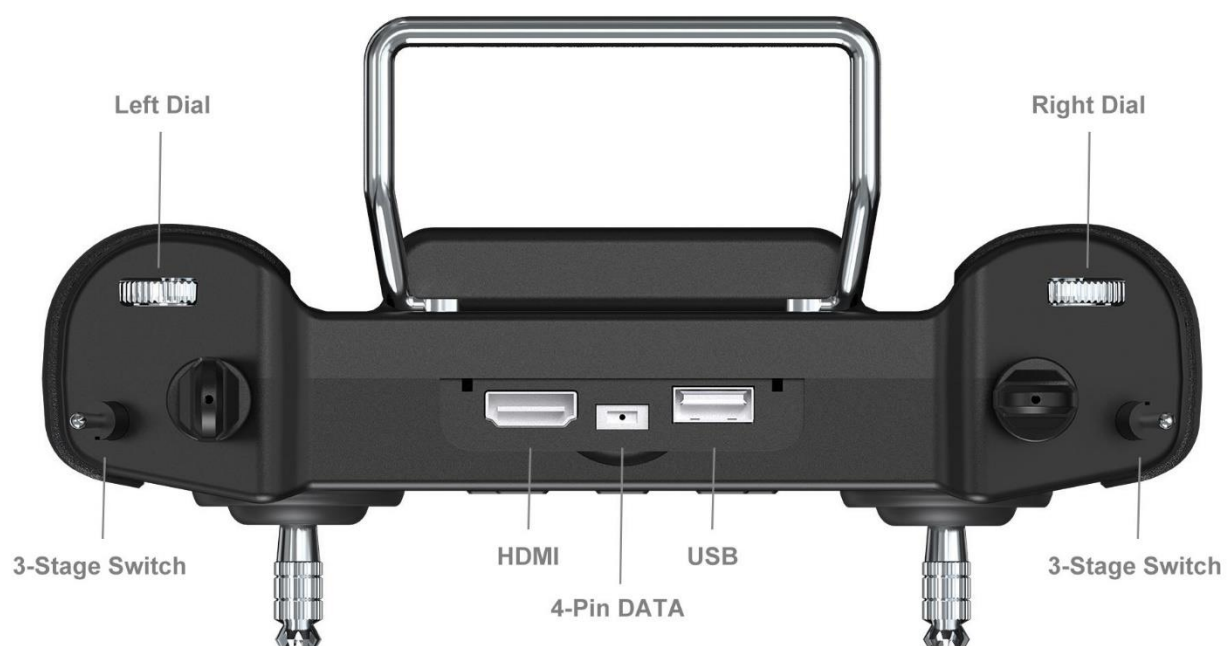

Overview – Transmitter Top

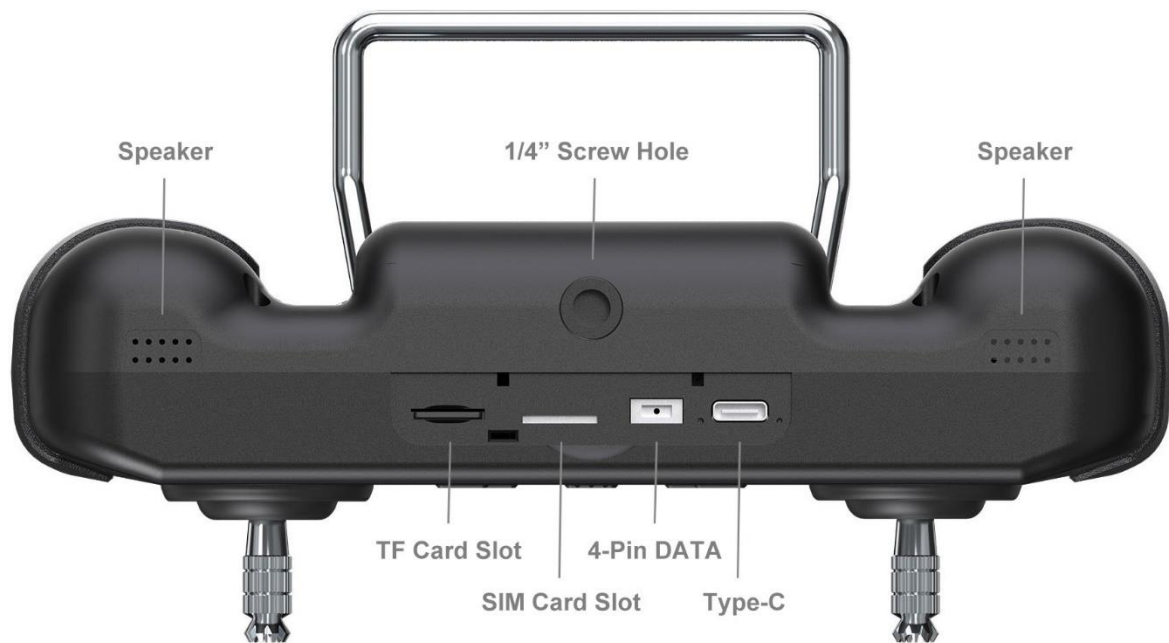

## Overview – Transmitter Bottom

## 1.2.4 Ports on MK15 Receiver

### MK15 Receiver Ports Definition

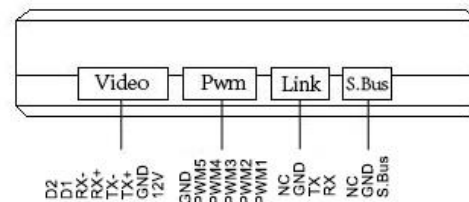
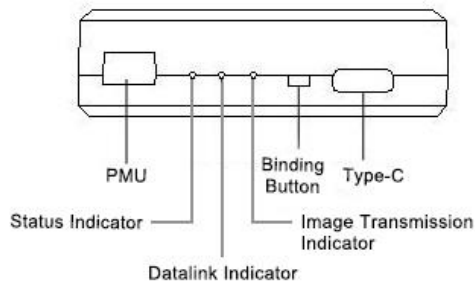
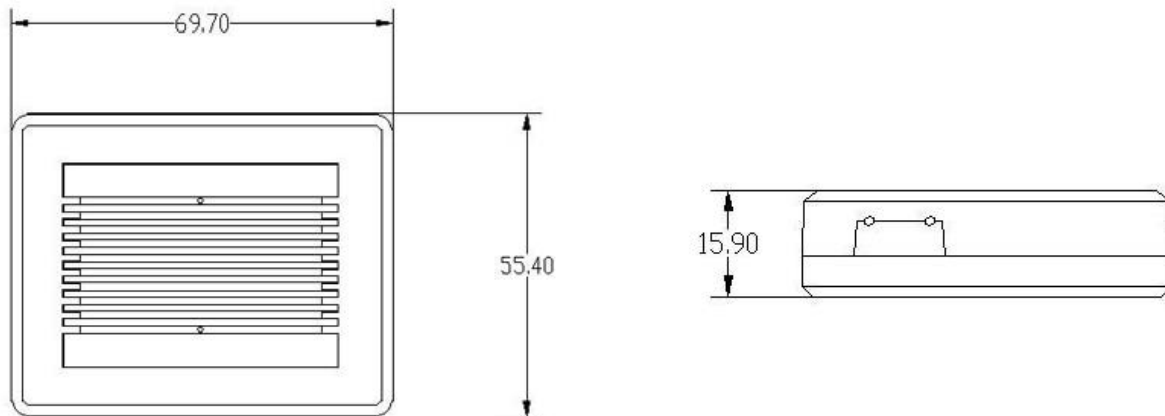

## 1.3 Technical Specification

### Overall

<b>Max Transmission Distance</b>	15 km (Unobstructed, free of interference)
<b>AG Control Range</b>	3.5 km (Flying at 3-meter height)

<b>Channels</b>	13 physical, 16 communicational
<b>Datalink Supported FC</b>	PIX / APM Boying Paladin V2 JIYI K3A Pro / K++ VKFLY V7-AG
<b>Videolink Supported GCS</b> (Standard RTSP video stream)	QGroundControl MissionPlanner JIYI IFLY / Agri-Assistant Boying Agriculture VKFLY V7 Pro

### Transmitter (Ground Unit)

<b>Monitor</b>	5.5-inch High Definition and High Brightness LCD Touchscreen
<b>System</b>	Android 9.0 2G RAM, 16G ROM
<b>Dimension</b> (Antenna Folded)	189 x 138 x 41 mm
<b>Weight</b>	850 g
<b>Battery Capacity &amp; Type</b>	10200 mAh 7.4V 2S Li-on
<b>Fast Charging Protocol</b>	PD 30W
<b>Battery Life</b>	15 hours
<b>Interface &amp; Ports</b>	Charging: Type-C Firmware Upgrade: DATA (4-Pin) Mobile Network: SIM Card Slot External Storage: TF Card Slot Tripod Connect: 1/4-inch Screw Hole Video Output: Standard HDMI External RTK: DATA (4-Pin) Data Transfer: USB-A
<b>Waterproof Level</b>	IP53
<b>Working Temperature</b>	-10°C ~ 55°C

### Receiver (Air Unit)

<b>Signal Output</b>	16 channels of SBUS 5 channels of PWM
<b>Interface &amp; Ports</b>	S.BUS: 3-Pin Datalink (to FC): UART 4-Pin PWM Channel 1-5: 6-Pin Video Input: 8-Pin Firmware Upgrade: Type-C
<b>Dimension</b> (Antenna Excluded)	70 x 55 x 16 mm
<b>Weight</b> (Antenna Excluded)	100 g
<b>Antenna Gain</b>	5 dBi
<b>Power Input</b>	25.2 ~ 58.8 V (6S ~ 14S)
<b>Working Temperature</b>	-10°C ~ 55°C

### Camera & Searchlight

<b>Camera Angle</b>	FOV 120°
<b>Dimension</b>	106 x 25 x 41 mm
<b>Weight</b>	108 g
<b>Searchlight Power Consumption</b>	8 W
<b>Luminous Flux</b>	1 W / 120 ~ 140 lm
<b>LED Type</b>	Transparent
<b>LED Angle</b>	120°
<b>Waterproof Level</b>	IP67
<b>Working Temperature</b>	-10°C ~ 55°C

## 1.4 Packing List

<b>Agriculture FPV Combo</b>	<b>Agriculture Dual FPV Combo</b>	<b>Enterprise Standard Combo</b>	<b>Enterprise FPV Combo</b>	<b>Enterprise HDMI Combo</b>
1 x MK15 AG Transmitter 2 x Standard Omni-Directional Antenna		1 x MK15 Enterprise Transmitter 2 x Standard Omni-Directional Antenna		
1 x MK15 Receiver 2 x Standard Omni-Directional Antenna				
1 x IP67 Camera with Searchlights	2 x IP67 Camera with Searchlights 1 x FPV Hub	2 x Long-Range Directional Antenna 1 x 8-Pin Cable	1 x IP Camera 2 x Long-Range Directional Antenna 1 x 8-Pin Cable	2 x Long-Range Directional Antenna 1 x 8-Pin Cable 1 x HDMI Converter 1 x HD Video Cable (Micro-HDMI to Micro-HDMI) 1 x Ethernet Power Cable
	1 x Telemetry Cable 1 x S.Bus Cable (Male) 1 x PWM Cable			
	1 x 20W PD Fast Charger (Type-C) 1 x Fast Charging Cable (Type-C to Type-C) 1 x Type-C to USB-A Converter			
	1 x Upgrading Cable			
	1 x Carrying Case			

<b>Dual Controller Standard Combo</b>
2 x MK15 Enterprise Transmitter 4 x Standard Antenna
1 x MK15 Receiver 2 x Standard Omni-Directional Antenna
4 x Long-Range Directional Antenna 1 x 8-Pin Cable
1 x Telemetry Cable 1 x S.Bus Cable (Male) 1 x PWM Cable
2 x 20W PD Fast Charger (Type-C) 2 x Fast Charging Cable (Type-C to Type-C) 2 x Type-C to USB-A Converter
2 x Upgrading Cable

## Mark

The difference between MK15 agriculture version and enterprise version are:

1. MK15 agriculture transmitter has no HDMI output.
2. MK15 agriculture receiver supports SIYI cameras only. It does not support a third-party IP camera or an HDMI camera.
3. The range of MK15 agriculture version is optimized for ground-to-ground transmission, while the range of MK15 enterprise version is



## 1.5 MK15 Common Diagram

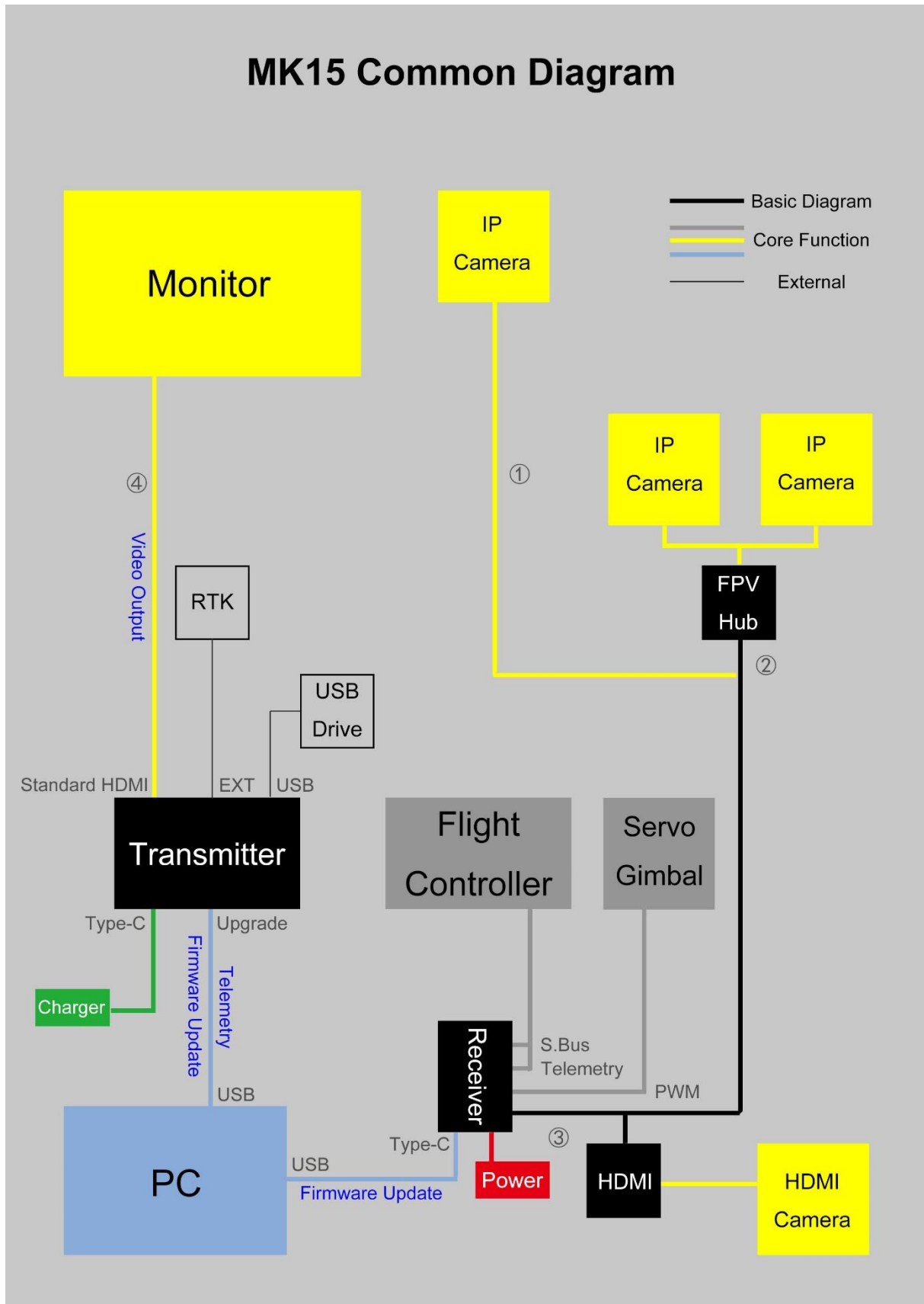

 **Mark**

Diagram ① means that MK15 receiver connects to only one IP camera or pod. You can use SIYI IP67 Camera (with searchlights), SIYI IP Camera, or Third-party IP Cameras / Pods. This diagram works when you purchase MK15 AG FPV Combo, or you purchase other MK15 combo to work with your available IP cameras / pod.

Diagram ② means that MK15 receiver connects to two IP cameras or pods through an FPV hub. You can use SIYI IP67 Camera (with searchlights), SIYI IP Camera, or Third-party IP Cameras / Pods. This diagram works when you purchase MK15 AG Dual FPV Combo, or you purchase the FPV Hub alone to work with your available MK15 combo and IP cameras / pods. The two video streams will display in the same screen in SIYI FPV app, or some specific ground station software. The display can be switched.

Diagram ③ means that MK15 receiver connects to an HDMI camera or pod through an HDMI converter. This diagram works when you purchase MK15 Enterprise HDMI Combo to work with your available HDMI camera / pod, or you purchase the HDMI converter alone to work with your available MK15 combo and HDMI IP cameras / pod.

Diagram ④ means MK15 transmitter outputs video stream to an external monitor through its standard HDMI port. The video stream will be the same with MK15 screen display.

## 1.6 MK15 Dual Remote Combo Diagram

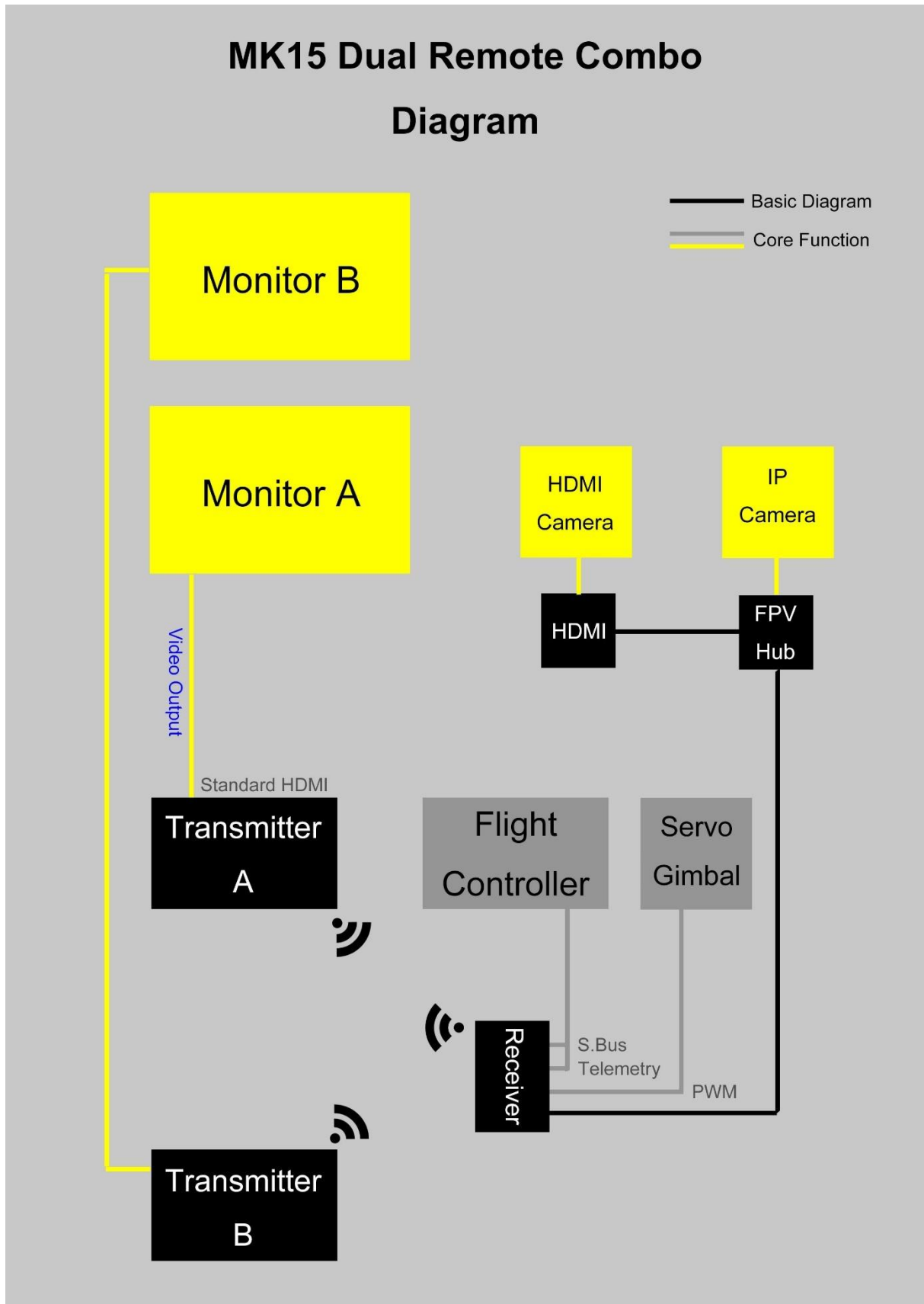

## Mark

MK15 Dual Remote Combo supports connecting two MK15 transmitters to one MK15 receiver.

The two transmitters can be assigned as transmitter A and B to work together in Dual Remote mode and RC Relay mode.

- Dual Remote: One transmitter controls motor (drone flight), the other transmitter controls the payload (gimbal or servo).
- RC Relay: One transmitter controls the drone to fly to the appointed location, then the pilots switch control to the other transmitter to finish the flight mission.

In Dual Remote mode, MK15 receiver connects up to two IP cameras through the FPV Hub, and it can connect HDMI camera through the HDMI converter.



When the Dual Remote Combo are connecting two cameras, transmitter A and transmitter B should display the video stream from either of the camera, not both. The video stream can be output to an external monitor through transmitter HDMI port or through Hotspot sharing. Both transmitter A and B have the declared features in MK15 Enterprise Combos.

## 1.7 Indicator Definition

















The status indicators on MK15 transmitter and receiver use three different colors and different blinking frequencies to indicate the system's working or abnormal status.

## 1.7.1 Transmitter Indicator

- Solid Red: No communication between transmitter and receiver.
- Fast Red Blinks: Transmitter is binding to receiver.
- Slow Red Blinks: Firmware does not match.
- ● ● Triple Red Blinks: Image transmission initialization failed.
- ● ● ● Four-time Red Blinks: Transmitter requires calibration.
- ● ● ● Red-Green-Red-Green-Red Blinks: Unexpected power off of MK15 Android system.
- Slow Yellow Blinks: Transmitter power voltage abnormal.
- ○ Double Yellow Blinks: Transmitter Bluetooth is not identified.
- ● Yellow-Red Blinks: Transmitter high-temperature alert, level one.
- ● ● Yellow-Red-Red Blinks: Transmitter high-temperature alert, level two.
- ● ● ● Yellow-Red Blinks: Transmitter high-temperature alert, level three.
- Solid Green: Perfect communication, receiving 100% data package.
- Green Blinks: Blinking frequency indicates the system's signal quality. More frequently it blinks, worse the signal quality is.
- Slow Green Blinks: Receiving 95% to 99% data package.
- Green Blinks (every 3/5 second): Receiving 50% to 75% data package.
- Green Blinks (every 3/10 second): Receiving 25% to 50% data package.
- Green Blinks (every 1/25 second): Receiving less than 25% data package.
- ● Green-Red Blinks: Receiver high-temperature alert, level one.
- ● ● Green-Red Blinks: Receiver high-temperature alert, level two.

-  Green-Red Blinks: Receiver high-temperature alert, level three.
-  Slow Red-Green-Yellow Blinks: Image transmission is starting.

## 1.7.2 Receiver Indicator

-  Solid Red: No communication between transmitter and receiver.
-  Fast Red Blinks: Transmitter is binding to receiver.
-  Slow Red Blinks: Firmware does not match.
-  Triple Red Blinks: Image transmission initialization failed.
-  Yellow Blinks: Low voltage alert (voltage input from PMU is lower than 12V).
-  Solid Green: Perfect communication, 100% data package received.
-  Green Blinks: Blinking speed indicates MK15 system's signal strength. The faster it blinks, the worse the signal is.
-  Slow Green Blinks: 95% to 99% data package received.
-  Green Blinks (every 3/5 second): 50% to 75% data package received.
-  Green Blinks (every 3/10 second): 25% to 50% data package received.
-  Green Blinks (every 1/25 second): less than 25% data package received.
-  Green-Red Blinks: Receiver high-temperature alert, level one.
-  Green-Red Blinks: Receiver high-temperature alert, level two.
-  Green-Red Blinks: Receiver high-temperature alert, level three.
-  Fast Green-Red-Green-Red-Green-Red Blinks: Wireless binding is starting (activated by power on/off three times).
-  Slow Red-Green-Yellow Blinks: Image transmission is starting.

## 2 GET READY TO USE MK15

### 2.1 Transmitter

#### 2.1.1 Power On/Off

Power On: Short press and long press combo.

When MK15 transmitter is off power, press the power button once, battery level indicators light on. Then immediately press and hold the power button for about two seconds, battery indicators will light on again but one by one this time. Transmitter is powered on.

Power Off: Long press.

When MK15 transmitter is working, press and hold the power button for about two seconds, Android system will pop up a window with some icons. Touch the power-off icon to power off MK15 transmitter.



### CAUTION

Forced Shutdown: When MK15 transmitter is working, press and hold the power button for about eight seconds, transmitter power will be forced to shut down.



### Mark

Screenshot: When MK15 transmitter is working, press and hold the power button for about two seconds, Android system will pop up a window with some icons. Touch the screenshot icon to make a screenshot of current screen display.

Screen Off: When MK15 transmitter is working, press the power button once, transmitter monitor will be off for saving battery power.

## 2.1.2 Charging

You can charge MK15 transmitter only when it is powered off and using the original PD fast charger.

### Steps

1. Connect MK15 transmitter to the PD charger and plug it into power supply.
2. The charging indicator lights on red, transmitter starts being charging.
3. When the charging indicator turns to green, charging is finished.



### CAUTION

Normal 5V charger adapter cannot charge MK15 transmitter, please do use SIYI original PD fast charger.

MK15 transmitter cannot be charged when it is working. Please do power off the transmitter before charging.

## 2.1.3 Charging Indicator

- Solid Red: In charging.
- Solid Green: Charging finished.



## 2.2 How to Place MK15 Antennas

Both MK15 transmitter and MK15 receiver are using SMA male connector for fixing antenna. Please make sure that the connectors are screwed tight in case of any influence to transmission quality and range.

### 2.2.1 How to Place Transmitter Antenna

As shown in the photo below, transmitter antenna should be placed vertically from the monitor and the head points upward, and its flat side should always point to your aircraft or vehicle.



### CAUTION

The two transmitter antennas should not be overlapped.

## 2.2.2 How to Place Receiver Antenna

As shown in the photo below, receiver antenna should be placed vertically from the carbon fiber board or the arms and the head points downward, and its flat side should always point to your transmitter.



**⚠ CAUTION**

The two receiver antennas can point upward on a plane. On multi-rotors, antenna must point downward.



Antenna feeder wires should be placed away from devices with much current and heavy interference, such as ESC and motors.

Length of the antenna feeder wire is 300 mm. The wire should not be overlapped or tied. Antenna SMA connector should avoid touching with the metal or carbon fiber structural parts. It suggested to keep a 10 mm distance between the parts and the connector, or you can isolate them in some ways.

The two receiver antennas should be placed apart from each other with a distance not less than 50 mm. To get the best transmission performance, please make sure that the antennas are not blocked or obstructed in operation.

### 3 SIYI TX APP

Users can configure MK15 transmitter in the pre-installed application “SIYI TX”.

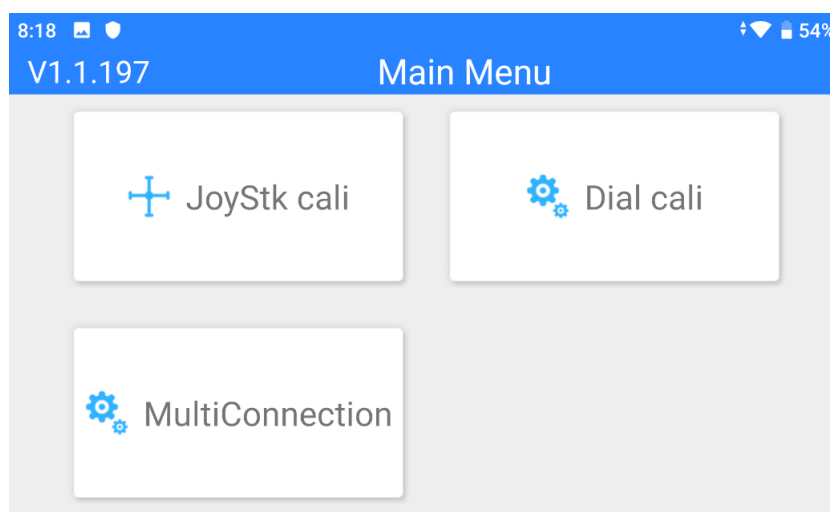
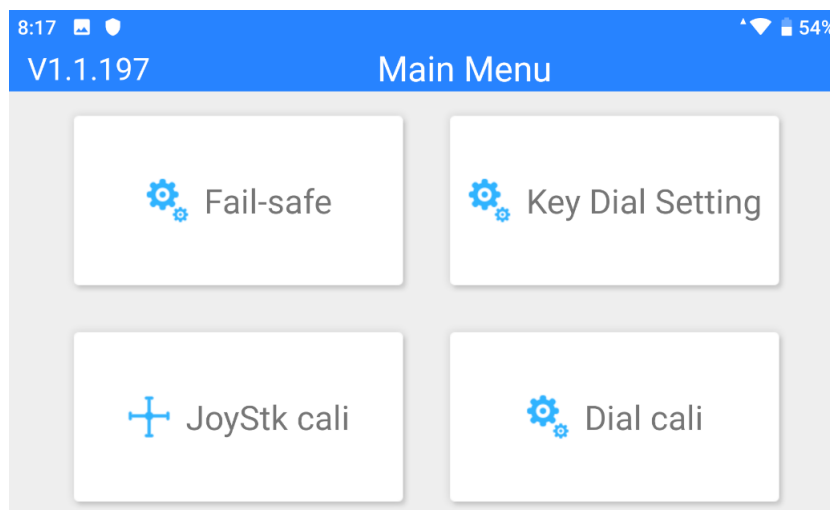
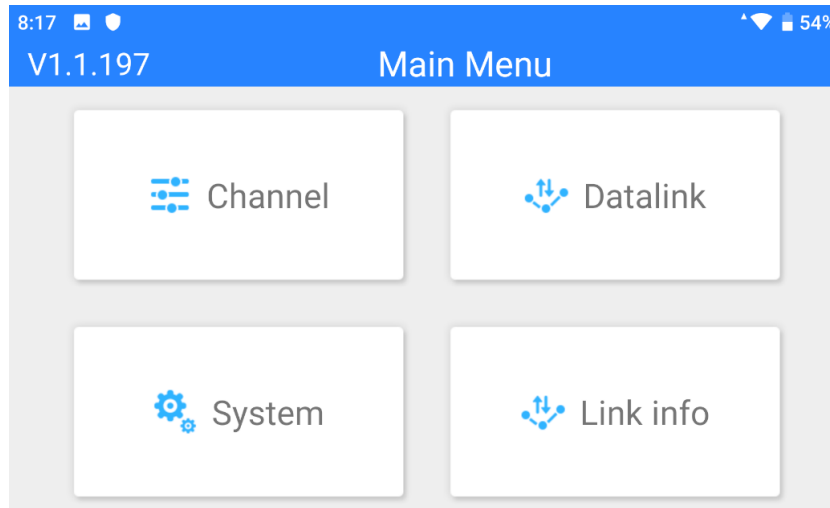



**Mark**

This chapter was made according to “SIYI TX” v1.1.197.

### 3.1 Channels

Channel settings of End Point, Middle Point, Channel Reverse, and Channel Mapping.

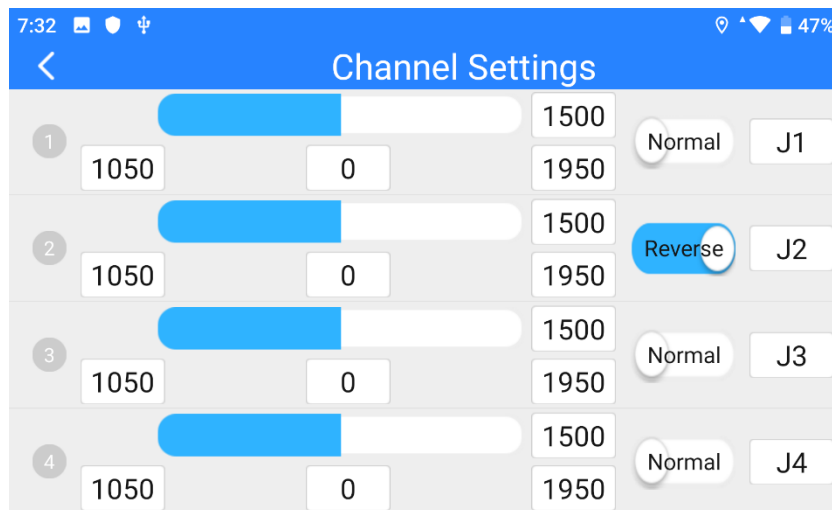

#### 3.1.1 End Point

MK15 transmitter’s default End Point range is between -100 and 100.

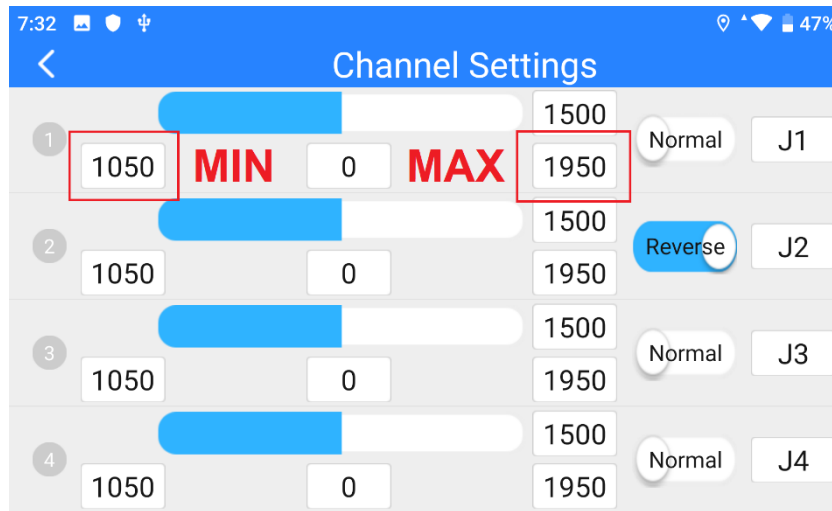

Select a target channel and input your required maximum or minimum channel value. It's done.

### 3.1.2 Middle Point

The default Middle Point value is “0”.

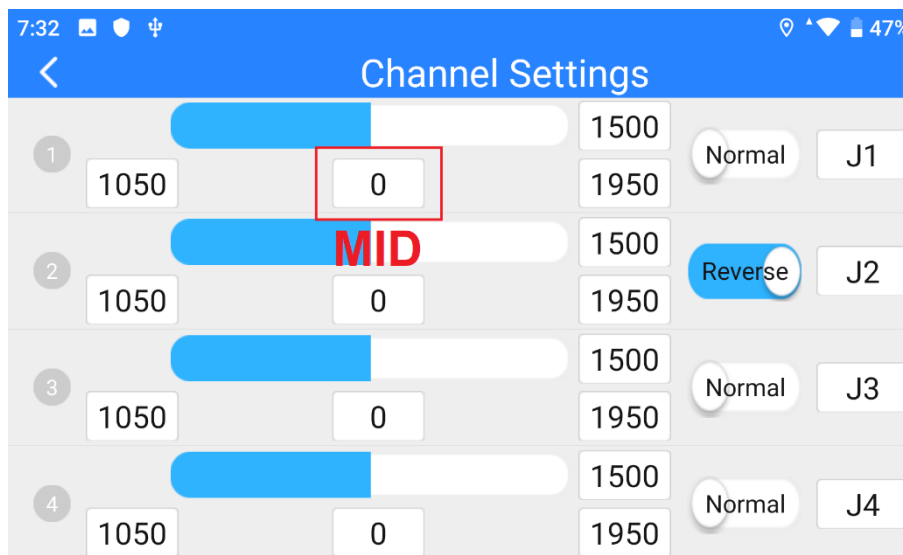

Select a target channel and input your required middle point value. It's done.

### 3.1.3 Channel Reverse

Channel Reverse is to reverse a channel's output direction.

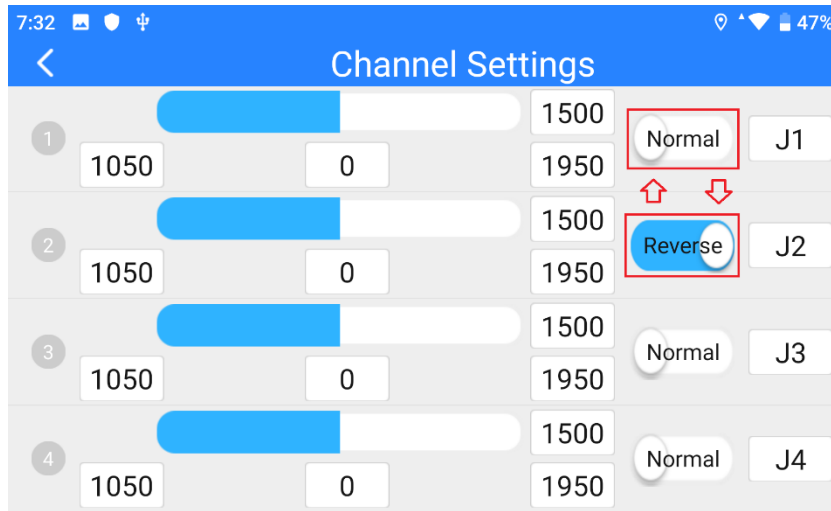

Select a target channel. Then touch the “Normal” or “Reversed” button. It’s done.

### 3.1.4 Channel Mapping

MK15 transmitter has 13 physical channels and 16 communicational channels. Users are allowed to define or map the physical channels (buttons, switches, joysticks) to communicational channels freely.

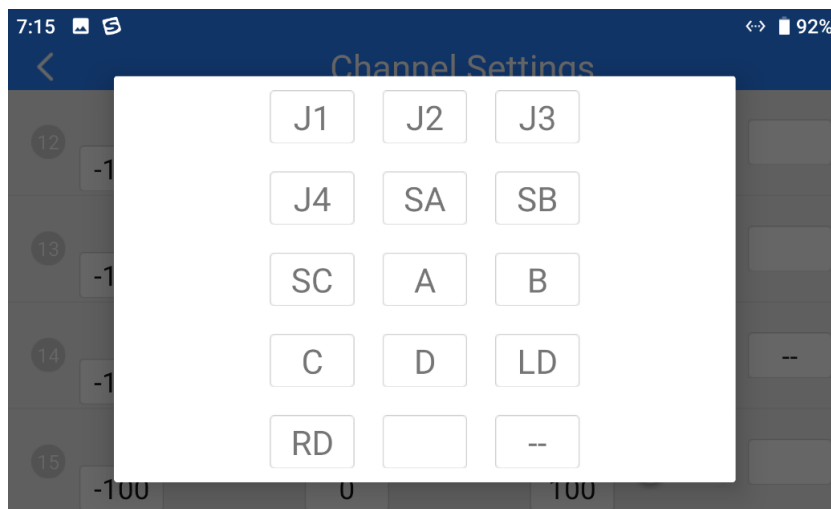

Select a target channel. Then touch a mapped button/switch/joystick, it will pop up a list of all physical channels. Select the button/switch/joystick you want to re-map to. It's done.

### 3.2 Datalink

In Datalink Settings you can check the device ID, switch datalink connection and flight controller type, and configure customized baud rate.

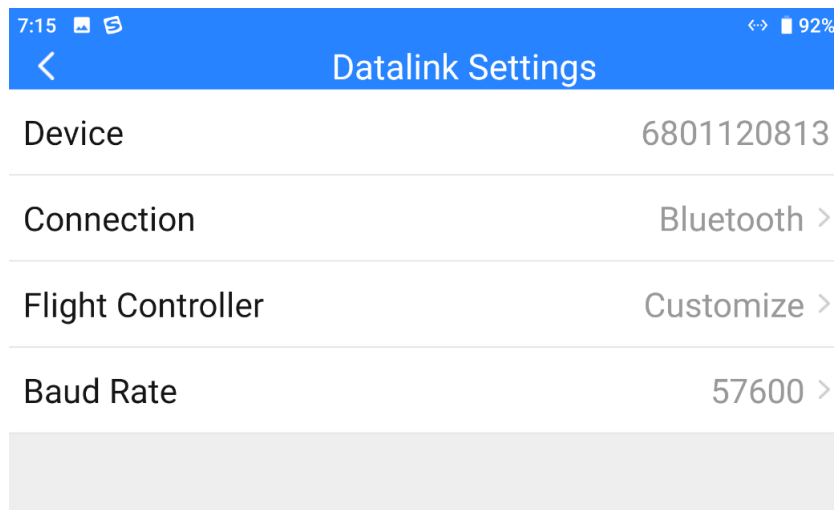

#### About Datalink Settings

**Device ID:** Display the device ID of the integrated Bluetooth module in MK15 transmitter.

It shows as the Bluetooth name before matching.

**Connection:** Supported datalink ports in MK15 transmitter.

**Flight Controller:** Support flight controller models by MK15 system.

**Baud Rate:** To configure required baud rate when you use customized flight controller.



### 3.2.1 Connection

Available datalink connection types are: UART, USB COM, Bluetooth, and Upgrade Port.

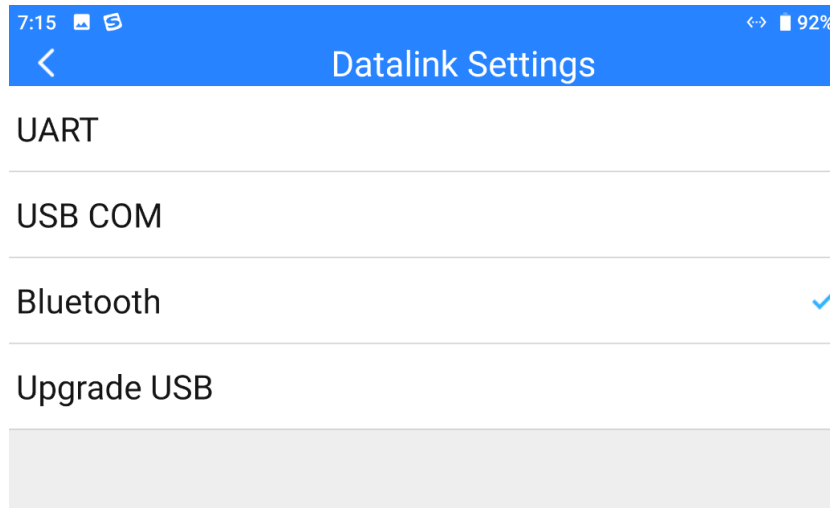

#### About Datalink Connection

UART: Telemetry data goes through the built-in Android UART port.

\*Only for specific GCS, such as BOYING, JIYI, and VKFLY.

\*Developers can acquire SDK from SIYI to use the port for their GCS.

USB COM: Telemetry data goes through the built-in CP2102 port.

\*For QGroundControl.

Bluetooth: Telemetry data goes through the built-in Bluetooth connection.

\*For most GCS.

Upgrade Port: Telemetry data be output to PC GCS through the Upgrade port at bottom MK15 transmitter.

### 3.2.2 Flight Controller

Select your required flight controller type for datalink connection in the provided list of all supported flight controller models.

Currently supported flight controller models are: JIYI (K3A or K++), BOYING (Paladin), PIX, VKFLY (V7AG), and Customized flight controllers.

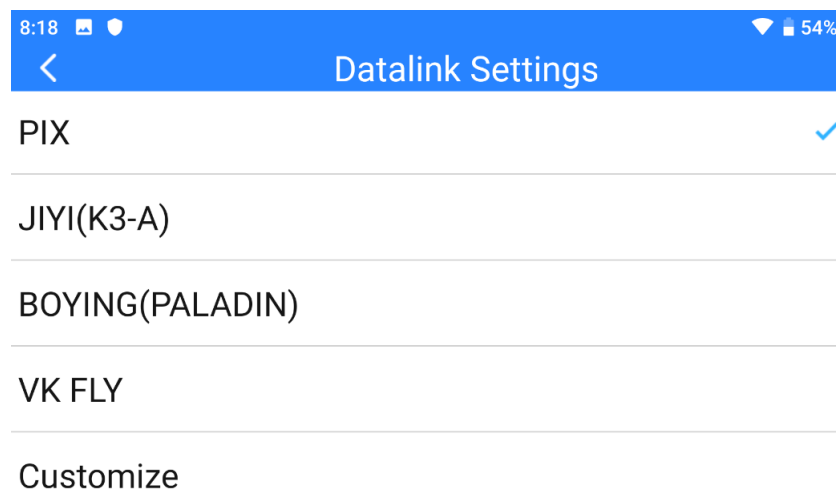

#### Mark

Please make sure that MK15 transmitter and receiver are bound before switching flight controller type.

### 3.2.3 Baud Rate

If your flight controller model was not found in the list, please choose “Custom” and manually configure the baud rate of your flight controller in this page.

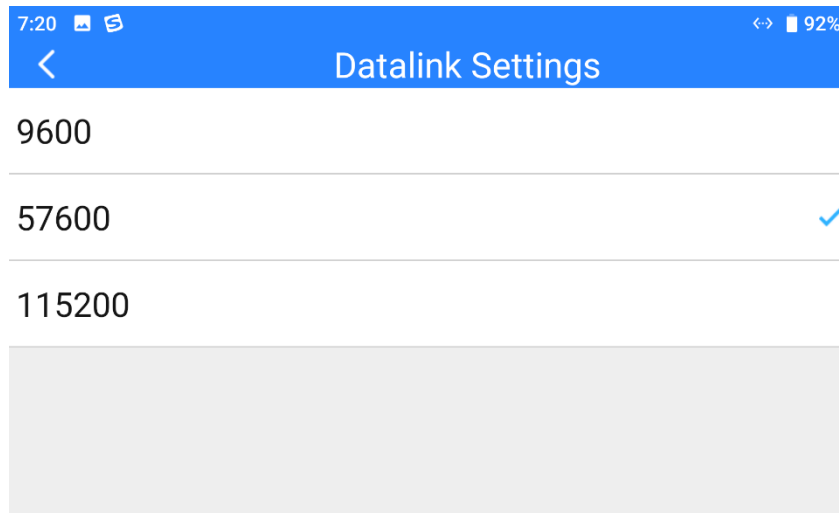

**Mark**

Please make sure that MK15 transmitter and received are bound before configuring baud rate, otherwise it would fail.

### 3.3 System

In “System Settings” page, you can bind transmitter with receiver, turn on or turn off frequency self-adapting function, switch throttle type, and check production date.

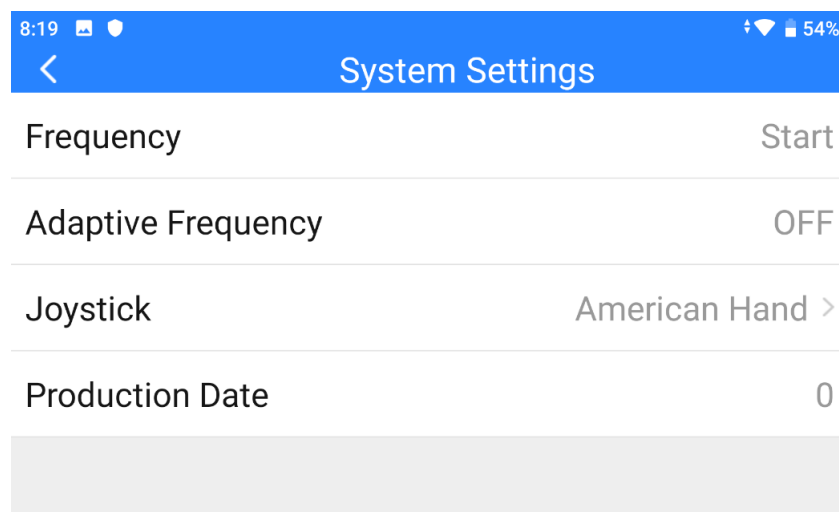

#### About System Settings

Bind: Check current binding status or start binding on transmitter.

Adapt Frequency.: Search and switch to the frequency band with lowest interference automatically.

Throttle: Switch throttle types among Mode 1, Mode 2, Mode 3, and Custom.

Production Date: Not implemented yet.

### 3.3.1 Bind

Please follow the steps below to bind MK15 transmitter with MK15 receiver.

1. In “SIYI TX” application, go to “System” page, then touch “Bind - Start”.
2. Transmitter status indicator will turn to “Red Fast Blinking”. In “Bind” menu, it displays “Binding”.
3. Press and hold the binding button on MK15 receiver for about two seconds, receiver status indicator will turn to “Red Fast Blinking” as well.
4. Please wait for 5 to 10 seconds till both transmitter and receiver status indicators turn to “Solid Green”. Binding is done.

### 3.3.2 Frequency Self-Adapting

In strong-interference environment, turn on the function, MK15 transmitter will automatically search for the frequency band with lowest interference to get the best transmission quality.



**Mark**

After turning on the function in “SIYI TX”, please restart MK15 transmitter, otherwise it won’t work.

The function is not implemented at this moment.

### 3.3.3 Throttle Type

Switch throttle joystick type. Available types are Mode 1, Mode 2, Mode 3, and Custom.

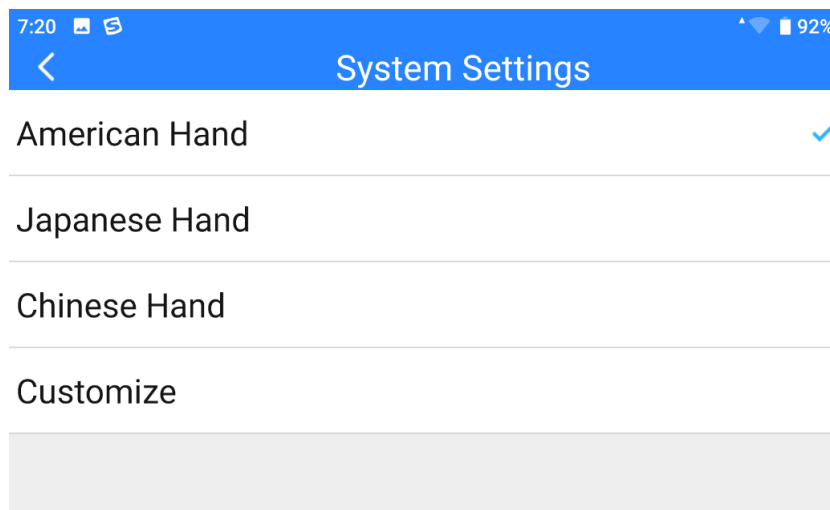

### 3.3.4 Production Date

Displays the production finished date of your MK15 transmitter.

## 3.4 Status

Link Status page digitalized MK15 system’s transmission quality by displaying the

link's real-time status in numbers and percentage.

The screenshot shows a mobile application interface with a blue header bar containing a back arrow, the text 'Link info', and system icons for time (7:20), signal strength, and battery (92%). Below the header is a table with the following data:

Metric	Value
Frequency	0
Loss rate	0%
Valid package	0
Valid package rate	0%
Data upload	0

### About Link Status

**Loss Rate:** Loss percentage of data package which failed to be received by MK15 transmitter per second.

**Received Pack:** Quantity of data package which are successfully received by MK15 transmitter per second.

**Received Rate:** Received percentage of data package which are successfully received by MK15 transmitter per second.

**Upload:** Data uploaded to MK15 receiver per second by bit.

**Download:** Data downloaded from MK15 receiver per second by bit.

### 3.5 Failsafe

After finishing binding your MK15 transmitter to MK15 receiver for the first time, please do configure the system with Failsafe function immediately.

Failsafe function is to avoid model crash by keeping receiver outputting the pre-configured channel value when the receiver lost communication with transmitter.

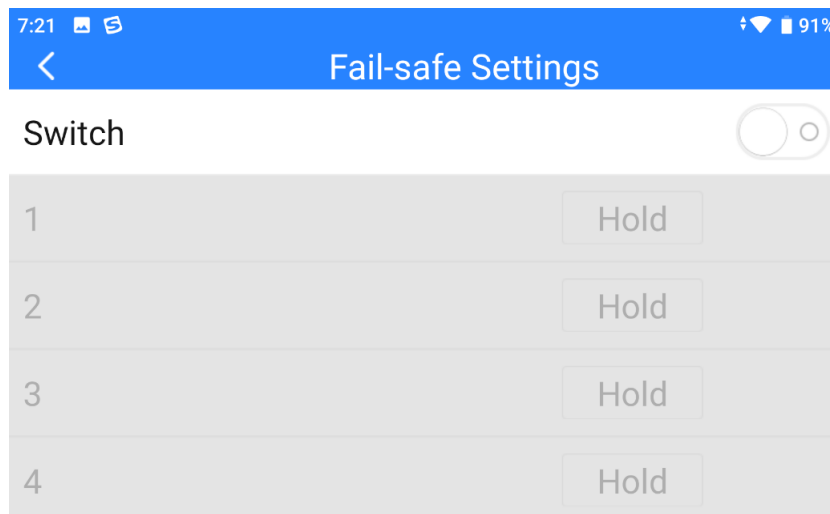

Please follow the steps below to configure your MK15 system with Failsafe function.

1. Make sure that MK15 transmitter is bound to receiver.
2. Go to "Failsafe" page.

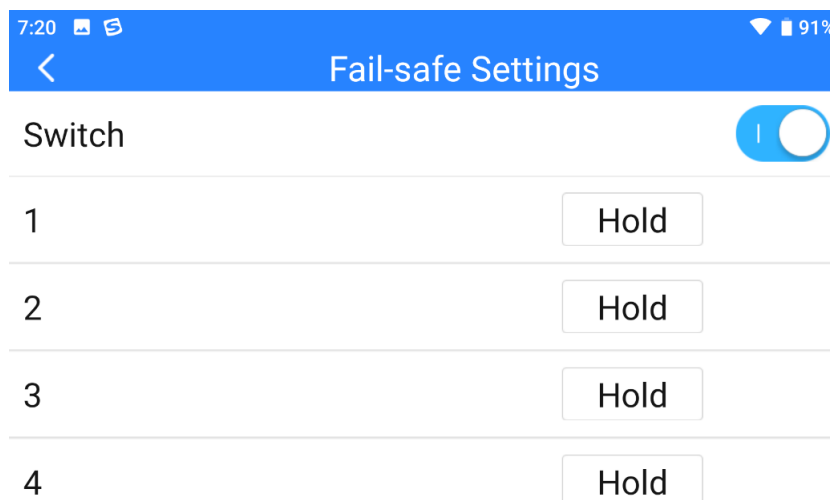

3. Failsafe function is not activated in default. The numbers on left represent channels. Channels display “Hold” when no channel value was input.
4. If you require a specific value in the channel, please turn on Failsafe switch first and turn the “Hold” button to “Custom”. Then input your required channel value.

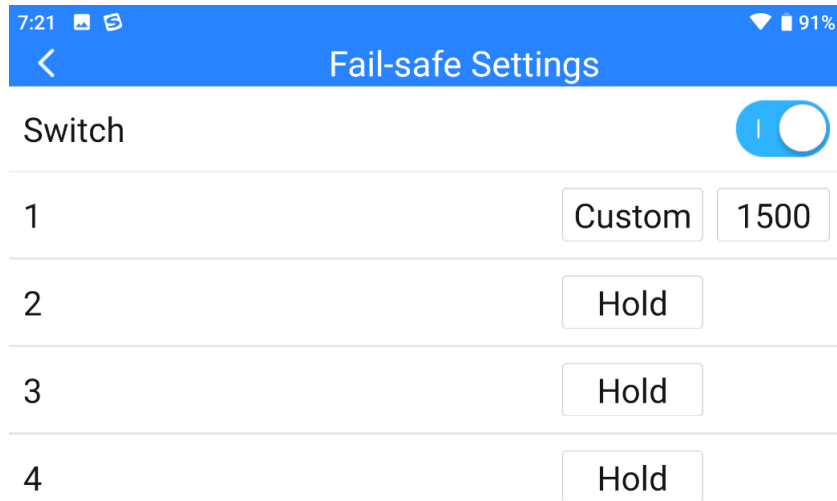

5. After configuration, the channel would output the value if receiver lost communication to transmitter.

**Mark**

If your flight controller communicates with your MK15 receiver through S.Bus protocol, then it is unnecessary to configure your MK15 system with Failsafe function(unless it is specially required by flight controller to trigger Failsafe function and switch to RTH, by holding a specific value in a channel). You just configure your GCS with protection measures, because there are Out-of-Control marks in S.Bus protocol which tells flight controller what situations belong to Out-of-Control.



### 3.6 Buttons / Dials

MK15 transmitter supports changing the way that the buttons and the dials work by software.

#### 3.6.1 Buttons

The function changes the way that the four buttons (A, B, C, D) on MK15 transmitter works.

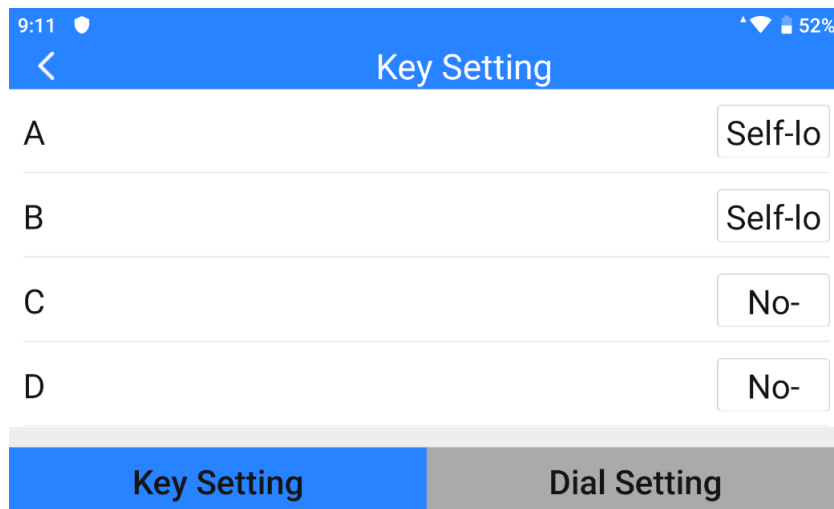

#### About Buttons

**Lock (Self-Locking):** After pressing, the button will bounce back but the channel will keep outputting 100. Press the button again to reset channel output to 0.

**Reset (Self-Reset):** Press and hold the button, the channel will output 100. Release the button, channel output resets to 0.



Press and hold the button, which means the channel outputs 100, LED under the button will light on. If the button is under “Self-Locking” status, the LED will be on still until the next pressing.

### 3.6.2 Dials

The function changes the way that the two dials (LD, RD) on MK15 transmitter works.

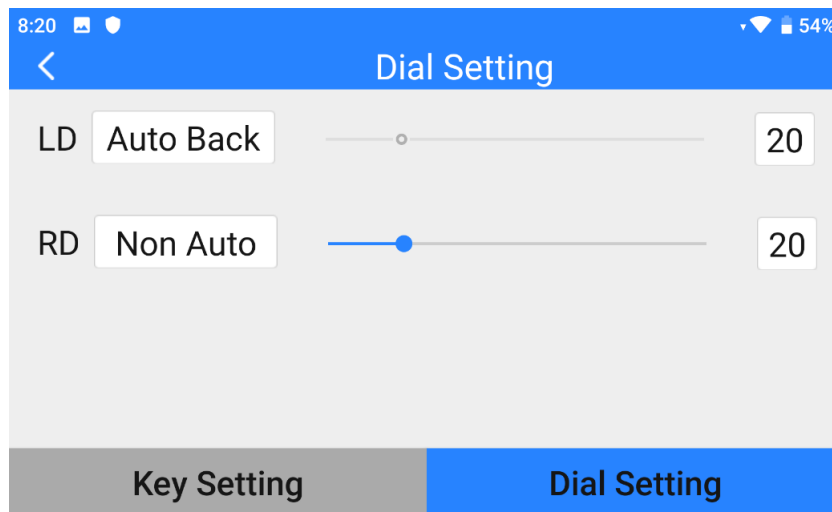

#### About Dials

**Auto Back (Self-Centering):** Under “Self-Centering” mode, when you push the dial and release, the dial’s outputting value will return to the initial value (middle point of the channel).

**Non-Auto (Thumbslide):** Under “Thumbslide” mode, when you push the dial and release, the dial’s outputting value will stay at the current value.

### 3.7 Joystick Calibration

Joystick calibration function help users calibrate both joysticks' middle positions and maximum/minimum positions. Regular calibration helps maintain control accuracy of the joysticks.

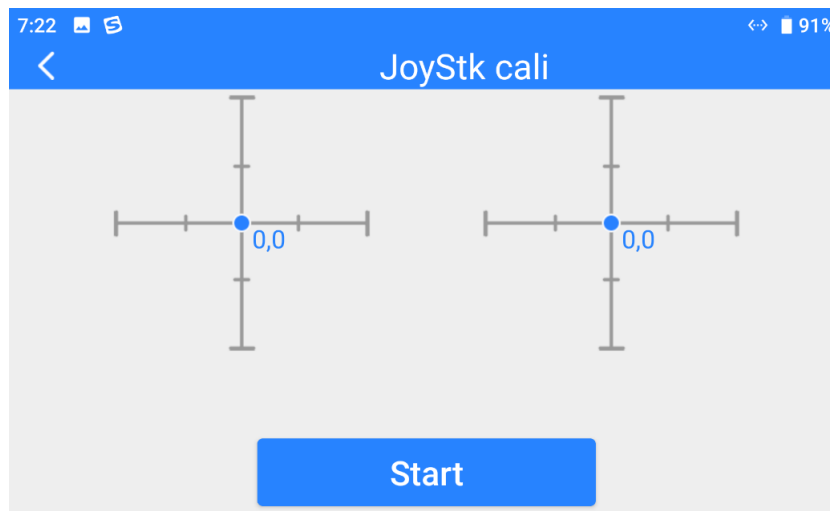

#### Steps

1. Before calibrating the joysticks, please make sure that both joysticks are naturally standstill, not displaced by any force.
2. In "Joystick Calibration" page, touch "Start", the page shows as below.

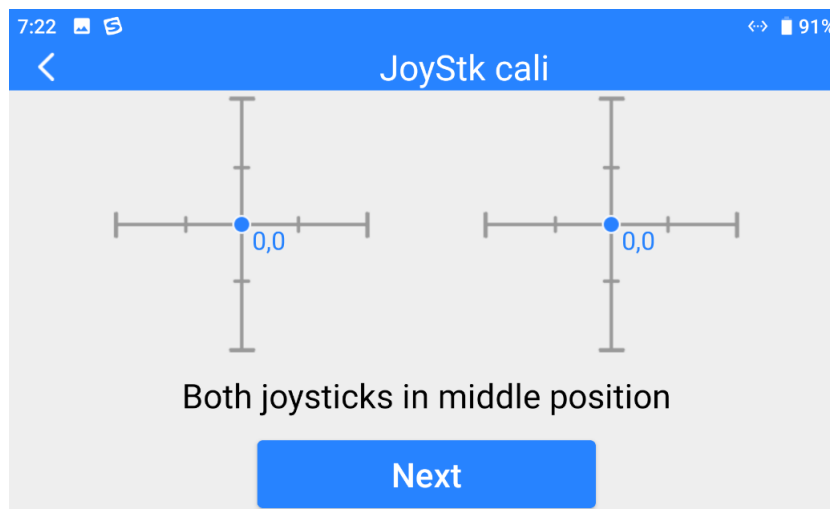

3. According to the tips, if joystick coordinates are not “(0, 0)” when both joysticks are standstill, it shows that joystick middle points are displaced. Please touch “next” and do not touch joysticks.

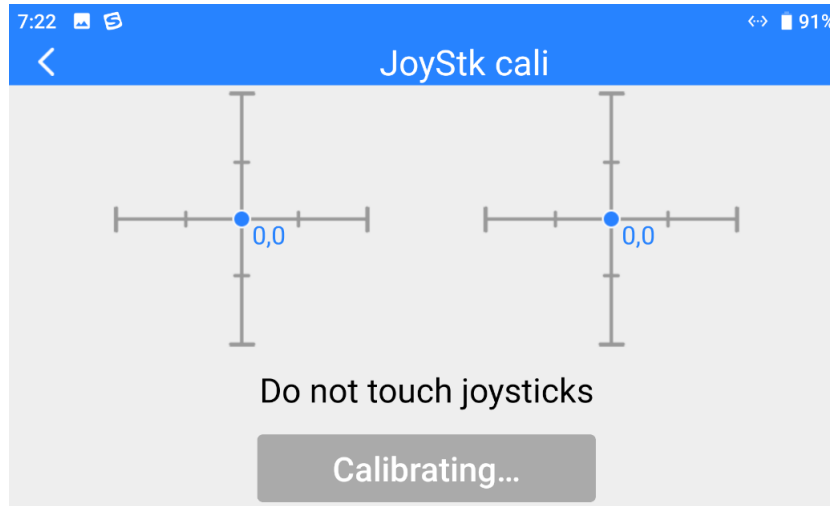

4. Calibration of joystick middle points are finished. The next step is to calibrate joystick maximum and minimum positions.

Please follow the tips again to push each joystick to its maximum/minimum positions on all four dimensions.

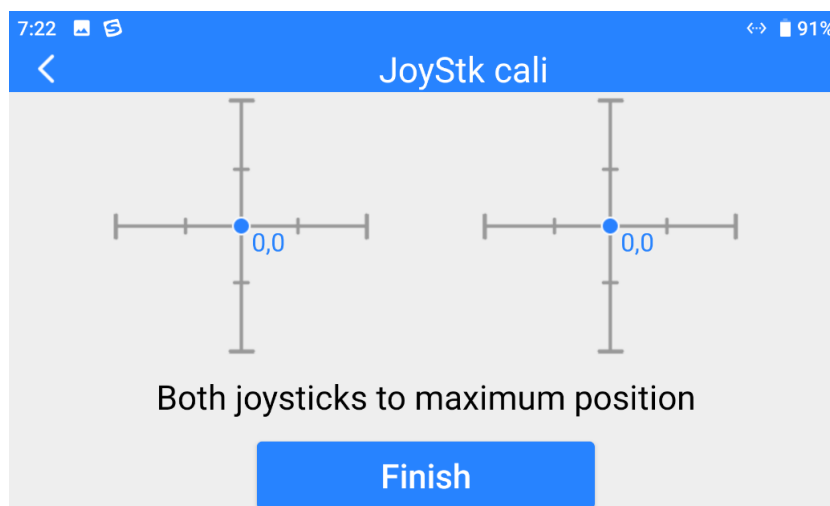

*Up: 0, 100*

*Down: 0, -100*

Left: -100, 0

Right: 100, 0

Then touch “Finish”.

5. The Joystick Calibration page will turn to its initial page. Joystick calibration is finished.

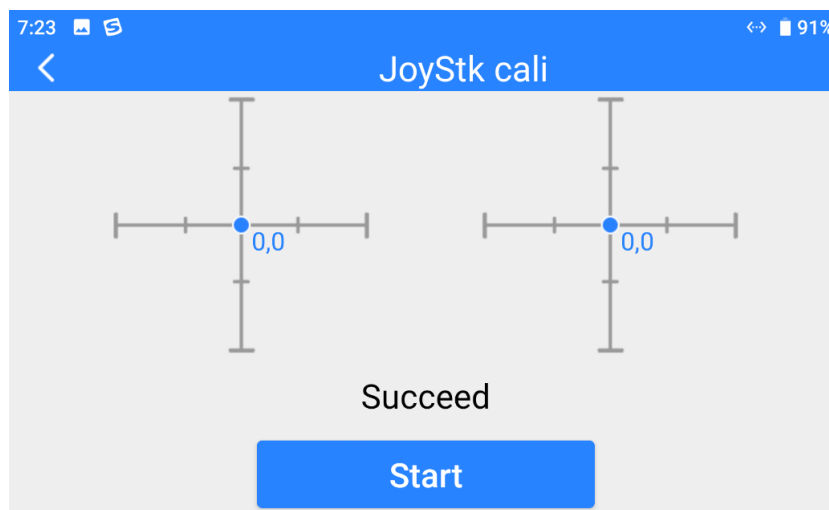

### Mark

If the joysticks do not stay in middle (coordinates are not (0, 0)) or do not output maximum/minimum value (-100 or 100), you shall calibrate them immediately.

## 3.8 Dial Calibration

Dial calibration function help users calibrate both dials' middle positions and maximum/minimum positions. Regular calibration helps maintain control accuracy of the dials.

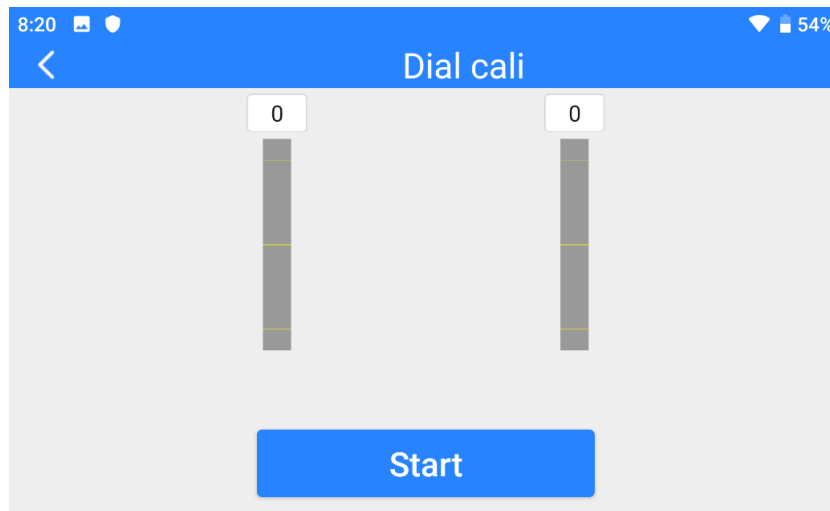

## Steps

1. Before calibrating the dials, please make sure that both dials are naturally standstill, not displaced by any force.
2. In “Dial Calibration” page, touch “Start”, the page shows as below.

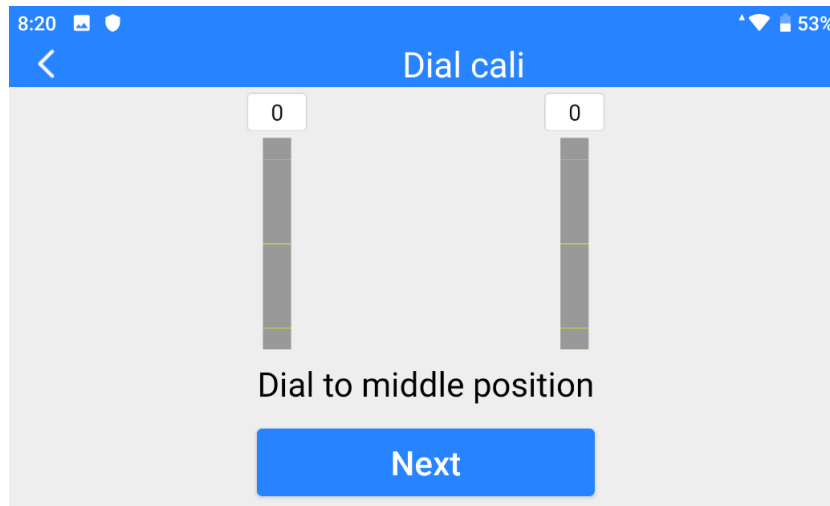

3. According to the tips, if dials’ coordinates are not “(0, 0)” when both dials are standstill, it means that dial middle points are displaced. Please touch “next” and do not touch the dials.

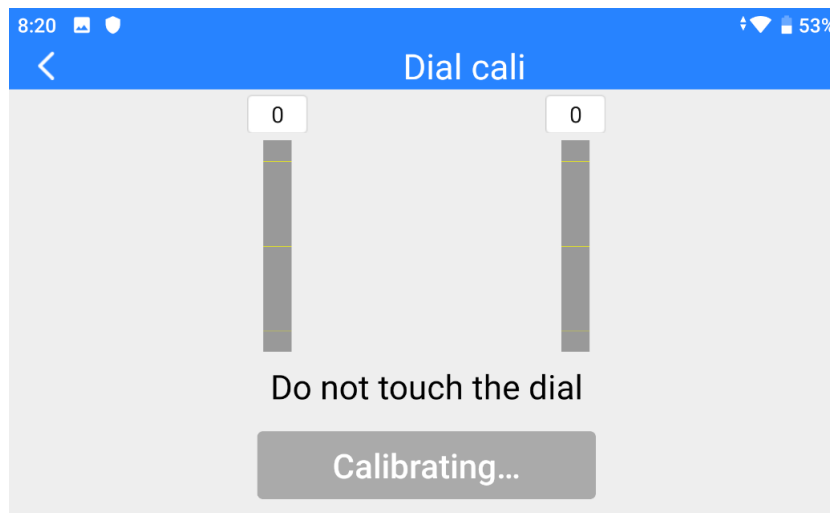

4. Calibration of dial middle points is finished. The next step is to calibrate dial maximum and minimum positions.

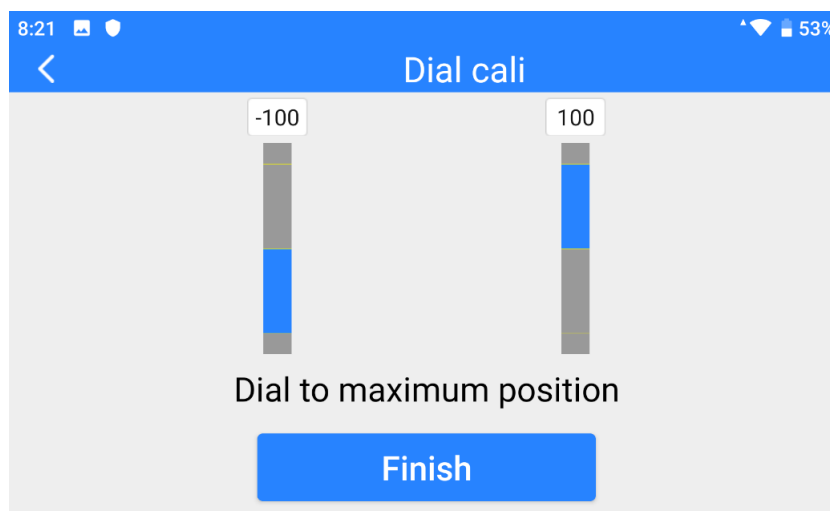

Please follow the tips again and push each dial to its maximum and minimum position.

Then touch “Finish”.

5. Dial Calibration page will return to its initial page. Dial calibration is finished.

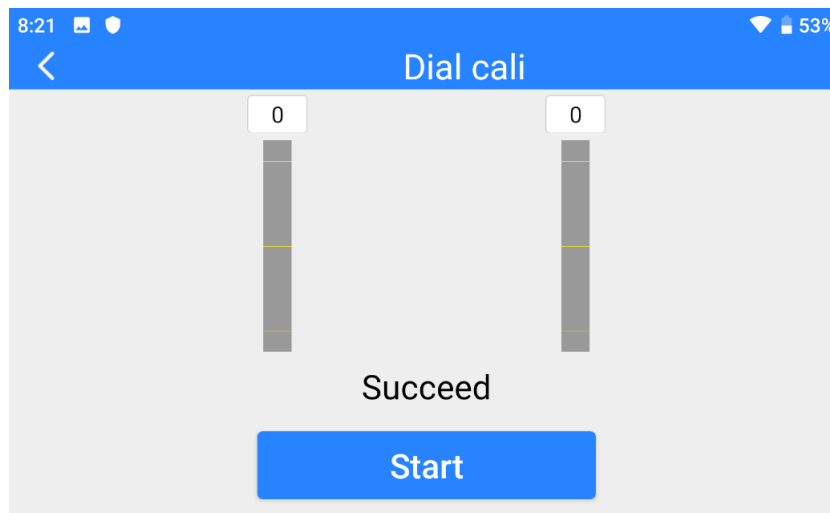

**Mark**

If the dials do not stay in middle (coordinates are not 0) or do not output maximum/minimum value (-100 or 100), you shall calibrate them immediately.

### 3.9 Multiple Links

The Multiple Links feature only comes with MK15 Dual Remote Combo, which includes details of its two main function “RC Relay” and “Dual RC”.

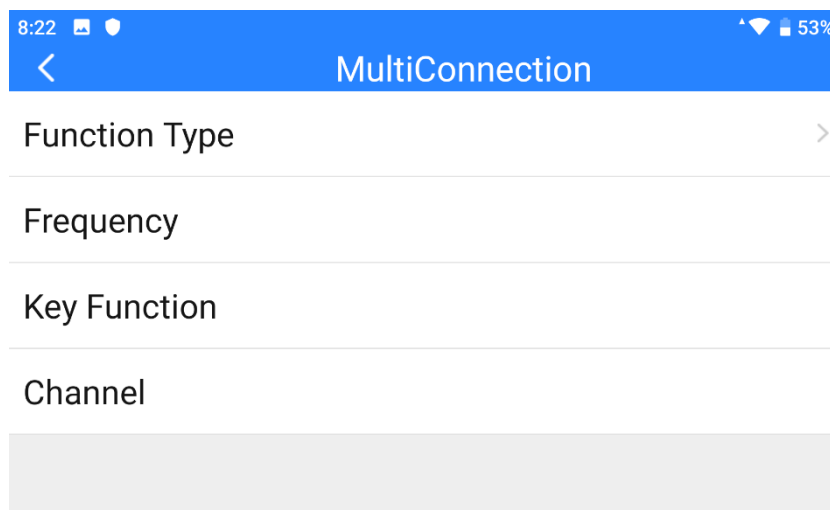



## About Multiple Links

**Function Type:** Switch the function between “RC Relay” and “Dual RC” and switching between “TX-A” and “TX-B” at the same time.

**Bind (Frequency):** Bind “TX-A” and “TX-B” with the receiver in turns after configuring function type.

**Control Switch (Key Function):** Define a button or a switch to take over the control in “RC Relay” mode, or to switch control of certain channels between “TX-A” and “TX-B” in “Dual RC” mode.

**Control Channel:** In “Dual RC” mode, define channel mapping for TX-A and assign channels to TX-B according to your requirement.

### 3.9.1 RC Relay

RC Relay function is specially developed for very long-range drone flight. In this mode, two transmitters relay control one receiver to reach twice of the limit flight distance of a single transmitter. The function can be widely used in enterprise drones for inspecting power lines, drone delivery and cargo shipping.

#### Steps

1. Prepare a MK15 Dual Remote Combo.
2. Go to “Multiple Links – Function Type”, assign the two transmitters as “Relay TX-A” and “Relay TX-B”.

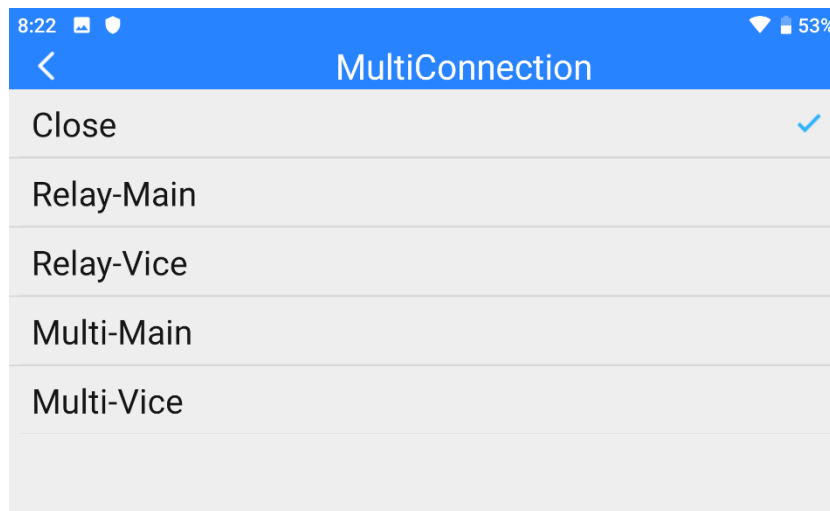

3. Bind “TX-A” and “TX-B” with the receiver in turns.
4. In “Control Switch” page, assign a switch/button/dial to switch control to the receiver from “TX-A” to “TX-B”.

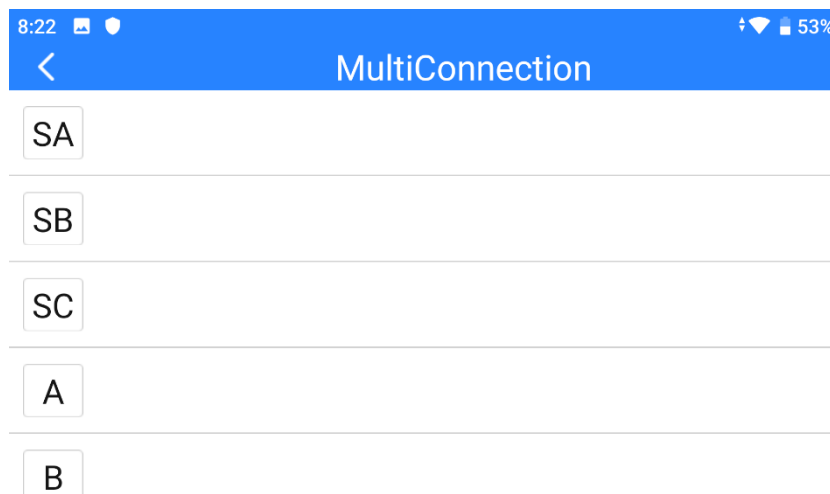

5. RC Relay settings are finished.

### 3.9.2 Dual RC

Dual RC function is developed for certain enterprise applications. In this mode, two transmitters control one receiver, one transmitter can be assigned to control drone

motors, and the other transmitter can be assigned to control payloads/gimbal/servos.

## Steps

1. Prepare a MK15 Dual Remote Combo.
2. Go to “Multiple Links – Function Type”, assign the two transmitters as “Dual RC TX-A” and “Dual RC TX-B”.

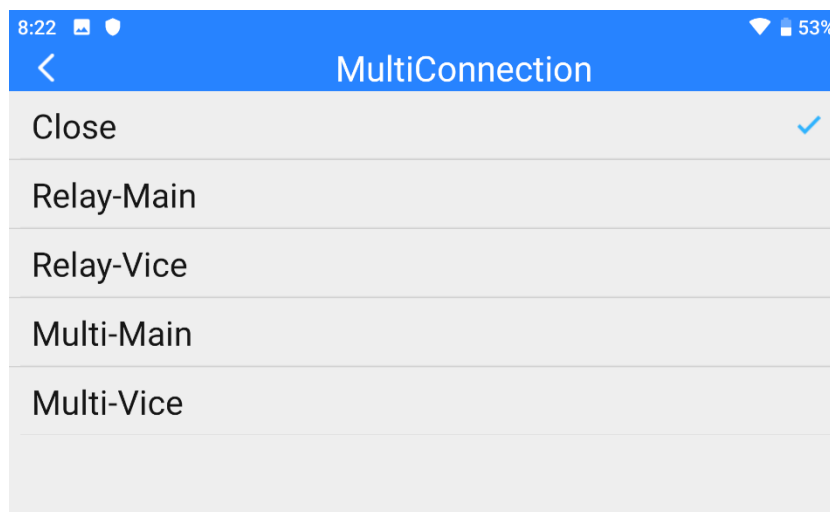

3. Bind “TX-A” and “TX-B” with the receiver in turns.
4. In “Control Switch” page, assign a switch/button/dial to switch control to the receiver from “TX-A” to “TX-B”.

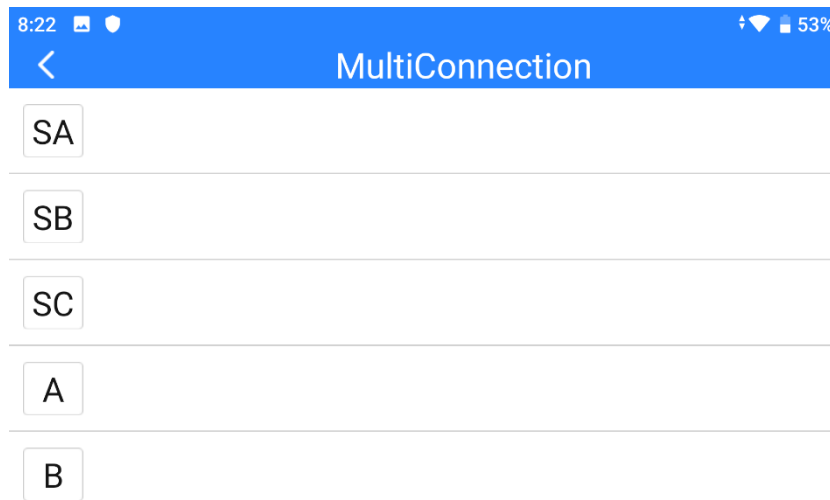

5. In “Control Channels” page, configure channel mappings for “TX-A”, then assign the decided channels to “TX-B”. So, when the Dual RC function is enabled, “TX-A” can authorize to “TX-B” or withdraw from “TX-B” the control of the assigned channels.
6. Dual RC settings are finished.

### Mark

Dual RC function works similar to Wireless Coach function. So, MK15 Dual Remote Combo can be used for drone training and education.

### DANGER

When Dual RC function is enabled and “TX-A” lost control to the receiver, “TX-B” will lose control to the receiver, either.

## 4 DATALINKS

Datalink is one of the core features of most SIYI radio systems.

MK15 transmitter supports communication with different ground control software through various hardware interface.

### 4.1 Communication with GCS through USB COM (Serial)

Let's take QGroundControl as an example.

1. In "SIYI TX" app, go to "Datalink", and choose "USB COM" in "Connection".
2. Open QGC, the software will pop up a window to ask if "Allow QGroundControl to access CP2102 USB to UART Bridge Controller?" Check and touch "OK".

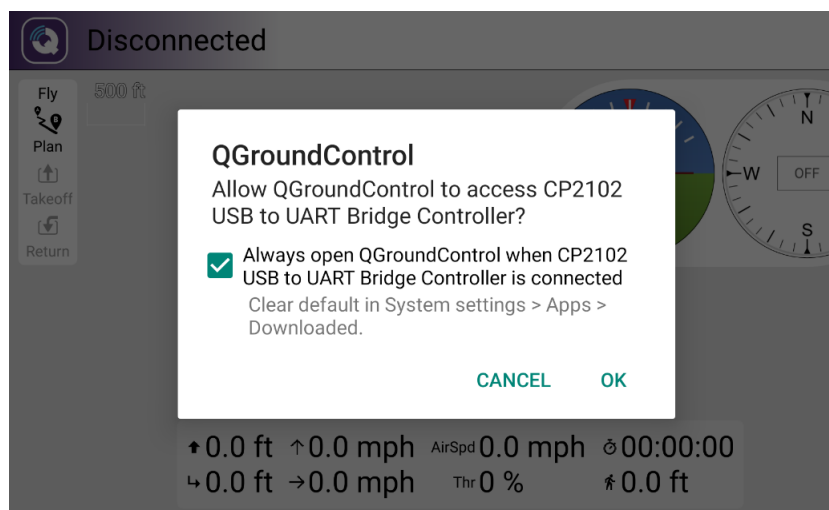

3. Go to "Application Settings" in QGC, touch "Comm Links" and "Add" a new connection.

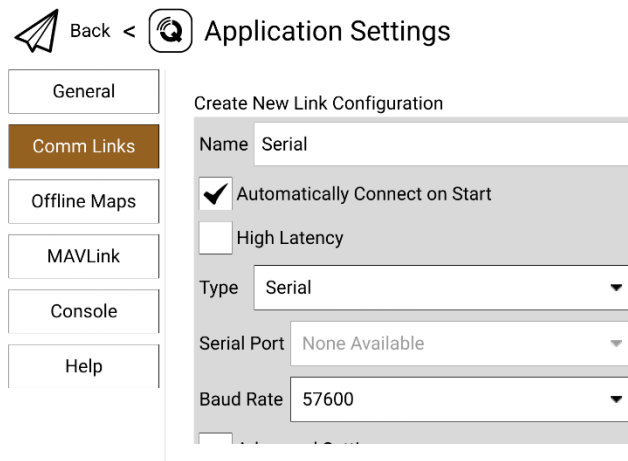

4. Name the connection as “Serial”, set the type as “Serial” and the baud rate as “57600”, then touch “OK” to return to the Comm Links page.

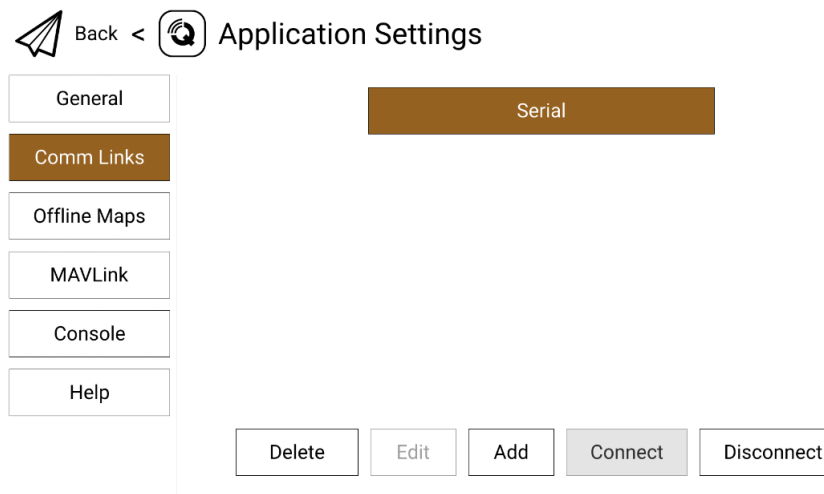

5. Touch the configured “Serial” connection and touch “Connect”, USB COM (Serial) connection is finished.

**Mark**

MK15 supports different baud rates. This guide uses common baud rate “57600” for your reference.

If it is your first time adding a new connection in QGC, please do not check the option “Automatically Connect on Start”. It can be checked later when you confirm that the datalink is connected successfully.

## 4.2 Communication with GCS via Bluetooth

Let’s take QGroundControl as an example.

1. In “SIYI TX” app, go to “Datalink”, and choose “Bluetooth” in “Connection”.
2. In Android OS, go to “System Settings - Bluetooth”, search the Bluetooth device with the same ID shown in “Device ID” (“SIYI 68\*\*\*\*\*”), and pair.
3. Open QGC, go to “Application Settings” page, touch “Comm Links” and “Add” a new connection.

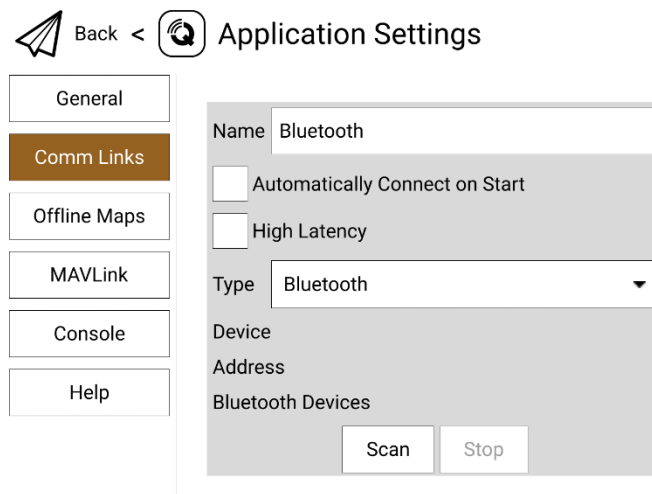

4. Set the type as “Bluetooth”, then touch “Scan”.

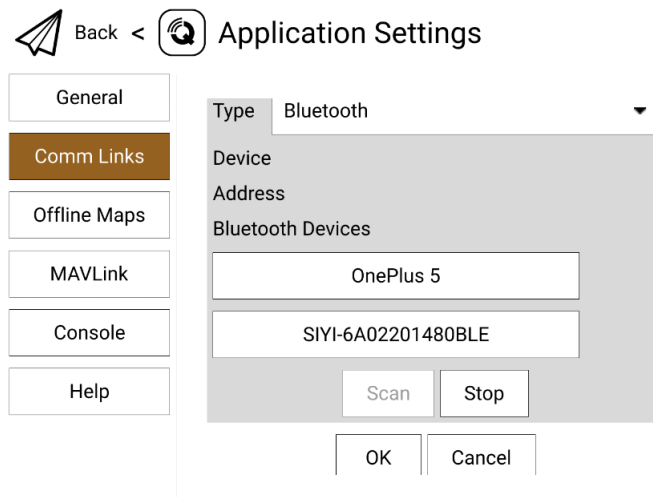

5. Touch the Bluetooth device of which the name is starting with “SIYI-XXXXXXX”, then touch “OK” to go back to the Comm Links page.

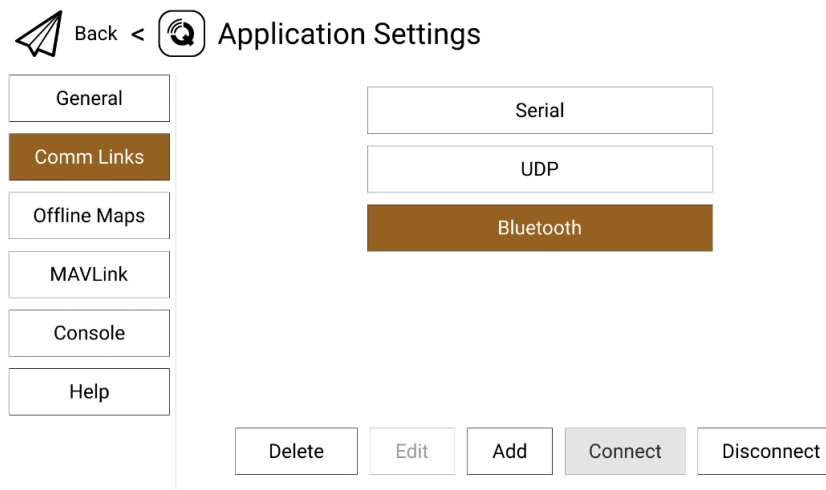

6. Touch the configured “Bluetooth” connection and touch “Connect”, Bluetooth connection is finished.

**Mark**

Step 1 and 2 have been finished before delivery.



If it is your first time adding a new connection in QGC, please do not check the option “Automatically Connect on Start”. It can be checked later when you confirm that the datalink is connected successfully.

### 4.3 Communication with GCS through UDP

Let’s take QGroundControl as an example.

1. In “SIYI TX” app, go to “Datalink”, and choose “UDP” in “Connection”.
2. Go to “Application Settings” in QGC, touch “Comm Links” and “Add” a new connection.

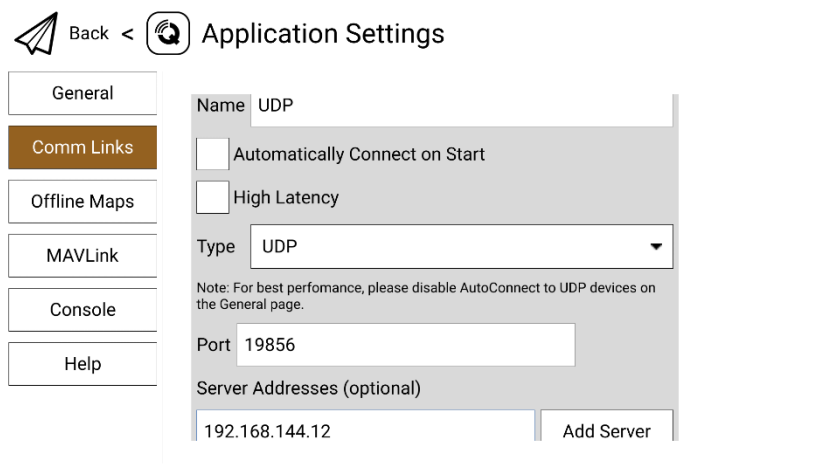

3. Name the connection as “UDP”, set the type as “UDP”, the port as “19856”, the server address as “192.168.144.12” and “Add Server”, then touch “OK” to return to the Comm Links page.

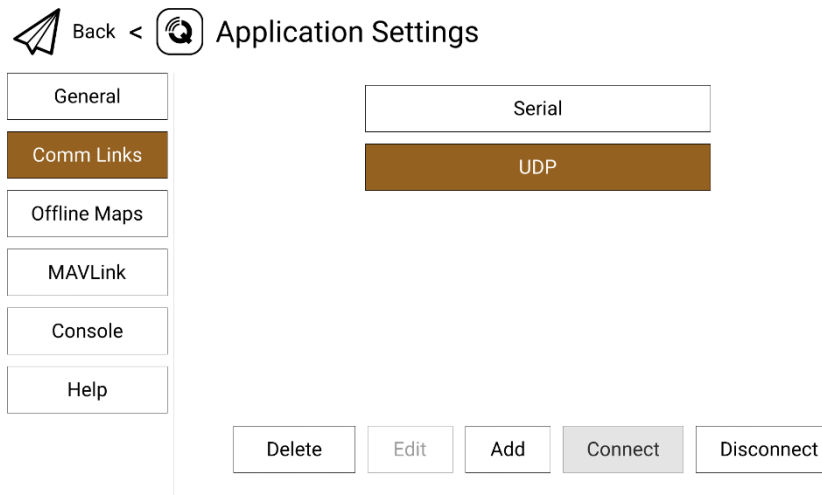

4. Touch the configured “UDP” connection and touch “Connect”, UDP connection is finished.

### Mark

UDP connection has not been updated to mass production. If you would like to try the connection, please contact SIYI Support directly.

If it is your first time adding a new connection in QGC, please do not check the option “Automatically Connect on Start”. It can be checked later when you confirm that the datalink is connected successfully.

## 4.4 Solutions to Disconnection

If MK15 system failed to establish telemetry link with GCS, please try to follow the steps below to investigate possible reasons.

1. Confirm if MK15 transmitter is bound with MK15 receiver.
2. Confirm if MK15 receiver is connected to flight controller through telemetry cable.

3. In “SIYI TX” app, go to “Status” page to check connection status between MK15 transmitter and MK15 receiver. When connection is normal, data “download” is not 0. If it is “0”, please go back to check step 1 and 2.
4. Then go to “Datalink” page and check:
  - If “Connection” port is correct?
  - If “Flight Controller” model is correct?
  - If “Baud Rate” is correct when you use customized flight controller.
5. In your GCS, check if “Datalink” port is correct.

## **Mark**

If you have done investigation by following all steps above, but the reason is still not located, please contact your dealer or SIYI immediately.

## 5 SIYI FPV APP

SIYI FPV is an Android application developed by SIYI Technology and for configuring image transmission, displaying video stream, and monitoring link status on SIYI smart controllers, remote controllers, and FPV modules.

### 5.1 Settings

In the “Settings” page, you can switch Decoding Type, configure IP Addresses, and enable Cross Sight.

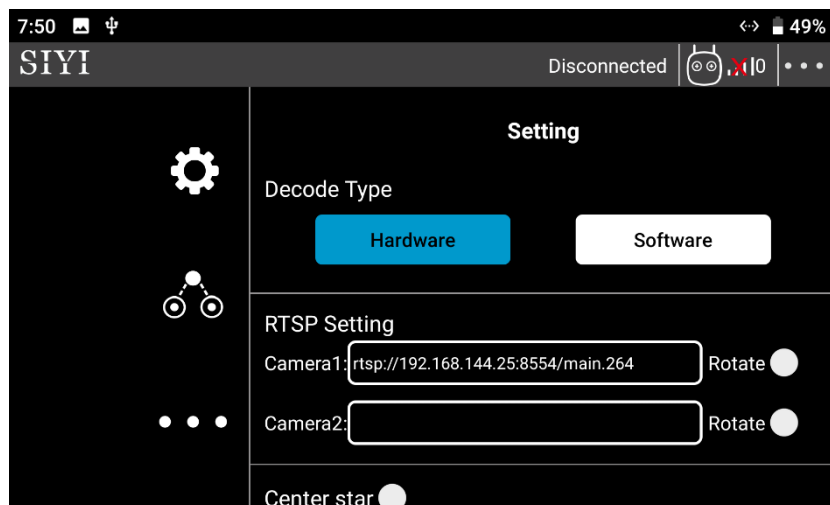

#### About Settings

**Decoding Type:** Switch between “Hardware Decoding” and “Software Decoding”. Please refer to your video input device to choose the decoding type with the best performance.

**IP Addresses:** Configure the IP address for camera A and camera B or for HDMI converter

A and B. The “Rotate” buttons after the addresses can rotate the image in 180 degrees.

Cross Sight: Display a cross sight in the center of the image.

## 5.2 Link Status

Display the link status directly over the FPV image.

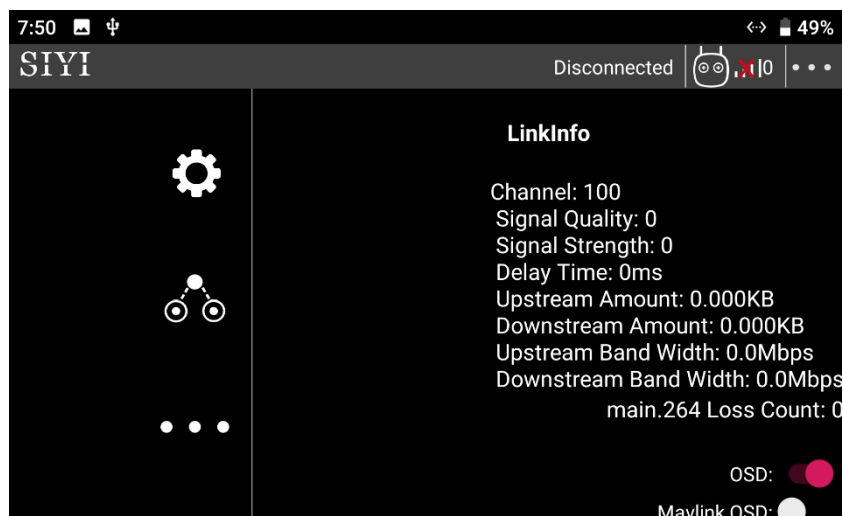

### Mark

For details of Link Status, welcome to refer to Chapter 3.4 in this manual.

## 5.3 About SIYI FPV

Displays the software version of SIYI FPV and common contact information of SIYI Technology.

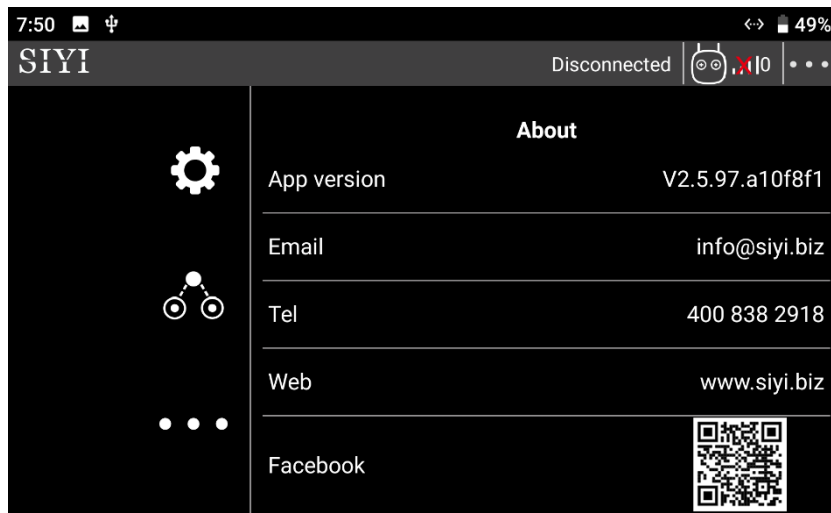

## 6 IMAGE TRANSMISSION

MK15 receiver supports maximum 1080p @ 60 fps and average 180ms low-latency HD image transmission. It connects to most IP cameras and pods on market and can connect to HDMI cameras/pods through an HDMI converter.

Please refer to the diagram in Chapter 1.5 of this manual to connect your SIYI IP Camera, Third-Party IP Camera/Pod, or HDMI Camera/Pod with MK15 receiver. Then follow the steps below to acquire image transmission display.

### 6.1 Using SIYI IP Cameras

Open SIYI FPV app, in a brand new MK15 system you can check video display without any settings after powering on the system.

### 6.2 Using Third-Party IP Cameras / Pods

Before connecting a third-party camera or pod to MK15 receiver, please change its IP address to “192.168.144.X”.

#### **Mark**

The X should not be “11”, “12”, or “20”, otherwise it won't work. The three addresses have been occupied by MK15 receiver, MK15 transmitter, and the Android system.

Let's take QGroundControl as an example.

1. In camera settings, check and copy the RTSP address of your IP camera/pod.
2. In QGC, go to "General" page and slide to "Video Settings".

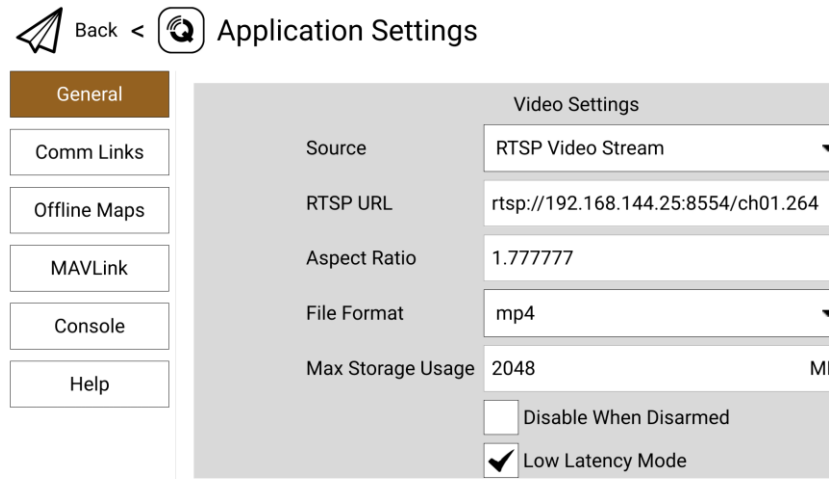

3. Configure "Source" as "RTSP Video Stream". Then input the copied RTSP address of your IP camera/pd after "RTSP URL".
4. Go back to QGC home page to check image display.

### 6.3 Using HDMI Cameras / Pods

If you use SIYI original HDMI converter to connect MK15 receiver with your HDMI camera, please refer to the steps below for acquiring image transmission.

Let's take QGroundControl as an example.

1. Open QGC, go to "General" page and slide to "Video Settings".
2. Configure "Source" as "RTSP Video Stream". Then input SIYI HDMI converter's RTSP address after "RTSP URL".
3. Go back to QGC home page to check image display.



## 6.4 Dual Video Stream Connection

After connecting the FPV Hub to MK15 receiver, dual video stream will work in many ways.

### 6.4.1 Dual SIYI IP Cameras

The two SIYI IP Cameras coming with MK15 Agriculture Dual FPV Combo are default to be Camera A and Camera B assigned with different IP addresses “192.168.144.25” and “192.168.144.26”. So, after connecting both cameras to the FPV Hub and open SIYI FPV app, you can see dual video stream when the correct RTSP addresses are input in the IP address bars.

#### **Mark**

The SIYI IP Camera coming with MK15 Agriculture FPV Combo, MK15 Enterprise FPV Combo, or sold alone is default to be Camera A, of which the IP address is “192.168.144.25”. When you purchase another camera for dual video stream, please make sure that you get Camera B.

Dual video stream does not work when the two streams use the same IP address.

### 6.4.2 Dual Third-Party IP Cameras

Make sure that the two IP cameras use different IP addresses and connect them to

the FPV Hub. Then open SIYI FPV app, input the IP addresses in the bar and you will see two video streams.

### **6.4.3 SIYI HDMI Converter and SIYI IP Camera**

The HDMI converter coming with MK15 Enterprise HDMI Combo or sold alone is default to be HDMI Converter A, of which the IP address is “192.168.144.30”. This IP has no conflict to either Camera A or Camera B. So, after connecting both the HDMI converter and the IP camera to the FPV Hub and open SIYI FPV app, you can see dual video stream when the correct RTSP addresses are input in the IP address bars.

### **6.4.4 SIYI HDMI Converter and Third-Party IP Camera**

Make sure that the IP camera use a different IP address from the HDMI converter and connect them to the FPV Hub. Then open SIYI FPV app, input the IP addresses in the bar and you will see two video streams.

### **6.4.5 Dual SIYI HDMI Converter**

The HDMI converter coming with MK15 Enterprise HDMI Combo or sold alone is default to be HDMI Converter A, of which the IP address is “192.168.144.30”. When you purchase another HDMI converter for dual video stream, please make sure that

you get the HDMI Converter B.

Then, after connecting the two HDMI modules with different IP to the FPV Hub and open SIYI FPV app, you can see dual video stream when the correct RTSP addresses are input in the IP address bars.

## Mark

Dual video stream does not work when the two streams use the same IP address.

For more details about the IP addresses of the MK15 parts, please refer to the chapter 6.5 in this manual.

## 6.5 Common IP Addresses

MK15 Receiver IP Address: 192.168.144.11

MK15 Transmitter IP Address: 192.168.144.12

MK15 Android System IP Address: 192.168.144.20

SIYI IP Camera A's IP Address: 192.168.144.25

SIYI IP Camera B's IP Address: 192.168.144.26

SIYI HDMI Converter A's IP Address: 192.168.144.30

SIYI HDMI Converter B's IP Address: 192.168.144.31

SIYI IP Camera A's RTSP Address: rtsp://192.168.144.25:8554/main.264

or rtsp://192.168.144.25:8554/ch01.264

SIYI IP Camera B's RTSP Address: rtsp://192.168.144.26:8554/main.264

or rtsp://192.168.144.26:8554/ch01.264

SIYI HDMI Converter A's RTSP Address: rtsp://192.168.144.30:554/live/0

SIYI HDMI Converter B's RTSP Address: rtsp://192.168.144.31:554/live/0

Common Video Player: SIYI FPV, QGroundControl, EasyPlayer

Video Display URL: Please refer to the address given in camera settings. Cameras from different manufacturers come with different URL.

Network Diagnosis Tool: Ping Tools

## 6.6 Solutions to No Image

If MK15 transmitter failed to display image, please try to follow the steps below to investigate possible reasons.

1. Confirm if MK15 transmitter is bound with MK15 receiver and confirm if the camera is connected to the receiver
  - Transmitter and receiver status indicator is red.
  - Receiver image transmission indicator is orange.
2. Open "SIYI FPV" app and check if the IP address of the camera or the HDMI converter is input correctly. SIYI IP camera and HDMI converter have been labeled with their IP addresses before delivery. For third-party IP cameras, please refer to the camera settings.
3. In the main menu of MK15 transmitter Android system, check if the Ethernet icon exists. If not, please enable Ethernet function.

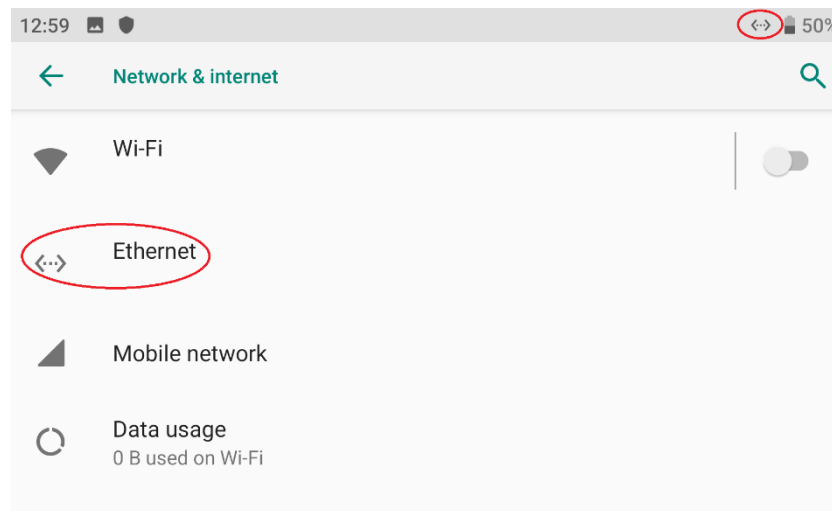

## Mark

If you have done investigation by following all steps above, but the reason is still not located, please contact your dealer or SIYI immediately.

## 6.7 Output Transmitter Image Display to Other Device

There are two ways to output MK15 transmitter image display to other devices.

### 6.7.1 Through Transmitter HDMI Port

Let's take an example of outputting image to an HDMI monitor.

Use a standard HDMI cable to connect MK15 transmitter's standard HDMI port with the monitor's HDMI port, the image of the transmitter screen will display in the monitor.

## Mark

MK15 Agriculture Transmitter does not support this function.

### 6.7.2 Through WiFi Hotspot

Let's take an example of outputting image to a Windows laptop, running QGroundControl.

1. Go to MK15 transmitter's Android system settings.
2. Then tap on "Network & Internet – Hotspot & Tethering – Wi-Fi Hotspot".

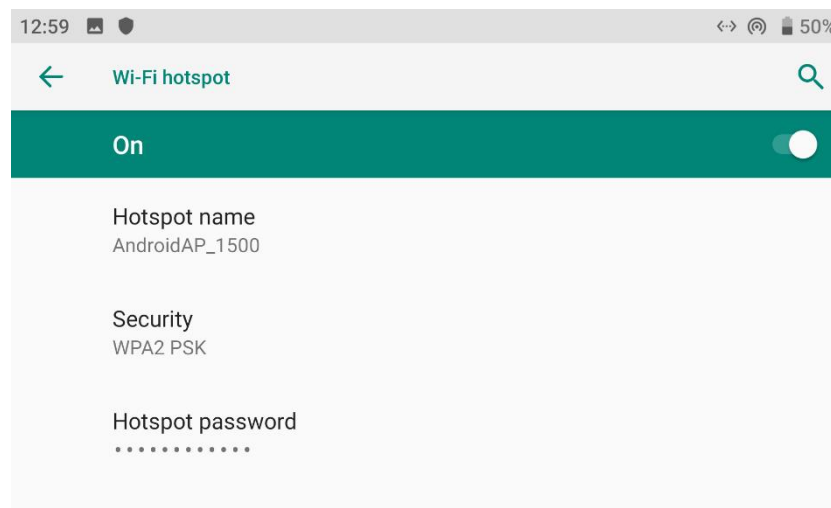

3. Enable "Wi-Fi Hotspot", configure the hotspot name and its password.
4. Connect the laptop's WiFi to the MK15 Android "Hotspot".
5. Open QGroundControl GCS on the laptop. Go to "Application Settings - Video".  
Change the video source to "RTSP Video Stream".

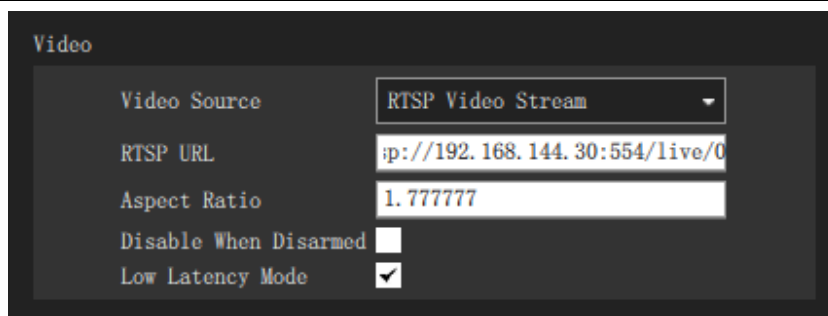

- In "RTSP URL", input the RTSP address of the camera or HDMI converter connected with MK15 receiver, then you will see the image from the camera or HDMI converter.

### Mark

If the same video stream is displayed in the device connected to MK15 transmitter Wi-Fi hotspot and in MK15 transmitter at the same time, then the displayed image may delay because of bandwidth limit. If it happens, please disable either one of the video display.

## 7 ANDROID OS

### 7.1 Download App

Pre-installed applications in MK15 transmitter are:

- SIYI TX
- SIYI FPV
- Ping Tools

If you need to download above apps, please visit the MK15 pages on SIYI Official Site ([www.siyi.biz](http://www.siyi.biz)) or SIYI Google Drive – MK15 ([https://drive.google.com/drive/folders/1yFk\\_Wb039xnR1uEdDX4ilys6J1CoyCk4?usp=sharing](https://drive.google.com/drive/folders/1yFk_Wb039xnR1uEdDX4ilys6J1CoyCk4?usp=sharing)).

### 7.2 Import and Install App

#### 7.2.1 Through TF Card

Save files into your TF card and insert the card into the TF card slot at bottom MK15 transmitter. Copy the files from the TF card to MK15 system storage, then go to “Files” in Android system to find the files and install.



## 7.2.2 Through USB Drive

Save files into your U disk and insert the card into the USB port on top of MK15 transmitter. Copy the files from your USB disk to MK15 system storage, then go to “Files” in Android system to find the files and install.



### **CAUTION**

Please try to simplify your MK15 Android system as much as possible and avoid install apps which are not useful to the system, in case of any unexpected issues during flight.



### **CAUTION**

Please do not set up any type of passwords for your MK15 Android system. If there is a need to lock or encrypt the Android system, please try to contact SIYI Technology (support@siyi.biz).





## 8 Firmware Upgrade

MK15 transmitter and MK15 receiver support firmware upgrading through PC.

Before upgrading, it is necessary to prepare the tools, software, and firmware below.

- SIYI Assistant (PC Software)
- MK15 Transmitter Firmware
- MK15 Receiver Firmware

### Mark

Above software and firmware can be downloaded from SIYI Official website or downloaded from     ([https://drive.google.com/drive/folders/1yFk\\_Wb039xnR1uEdDX4iIys6J1CoyCk4?usp=sharing](https://drive.google.com/drive/folders/1yFk_Wb039xnR1uEdDX4iIys6J1CoyCk4?usp=sharing)) or got from your dealer.

- Upgrade Cable (UART to USB)
- Fast Charging Cable (Type-C to Type-C)
- Converter (Type-C to USB)

### Mark

Above tools come with MK15 package.

Fast charging cable and converter can be used to upgrade MK15 receiver firmware.

## **Firmware Upgrade Steps**

1. Install “SIYI Assistant” into your Windows system.
2. Use the upgrade cable to connector computer’s USB port to MK15 transmitter’s upgrade port.
3. Run “SIYI Assistant” and switch to “Upgrade” page to check the MK15 transmitter’s current firmware version.
4. If MK15 transmitter’s firmware is not the latest, then click the “Select File” button after “Transmitter” line to import the latest transmitter firmware. Then click “Upgrade” and wait till it is “100%” finished.
5. Disconnect MK15 transmitter with computer. Connect MK15 receiver to computer. Then repeat above steps to upgrade receiver firmware.

## 9 After-sale Service

If there were any questions or problems using SIYI Technology's product, you can always try to send an email to SIYI Official A/S Center ([support@siyi.biz](mailto:support@siyi.biz)) or consult your sales representative or dealer for answers or solutions.

### 9.1 Repair Service

If your purchased SIYI products cannot work properly, please contact SIYI Official A/S Center for consulting.

Usually there are two situations for acquiring repair service.

- Product Defect
- Product Damage

SIYI products under the two situations can be sent back to SIYI for repairing. Defect products with valid warranty can be repaired for free. Defect products without valid warranty or damaged products should be charged of repair fees after repairing. Please refer to SIYI's Official A/S Quotation for detail.

## 9.2 Warranty

SIYI Technology guarantees that, subject to the following conditions, Return & Refund Service, Replacement Service, and Warranty Repair Service can be requested. Please contact SIYI directly ([support@siyi.biz](mailto:support@siyi.biz) or your sales manager) or authorized SIYI dealer for more detail.

### 9.2.1 7-Day Return & Refund

You can request Return & Refund Service:

Within seven (7) days of receiving a product if the product has no manufacturing defect, has not been activated and is still in new or like-new condition.

Within seven (7) days of receiving a product if the product has a manufacturing defect.

Return & Refund Service will not be provided where:

It is requested beyond seven (7) calendar days of receiving a product.

A product sent to SIYI for Return & Refund Service does not include all original accessories, attachments or packaging, or any item is not in new or like-new condition, i.e., with cracks, dents, or scratches.

A legal proof of purchase, receipt or invoice is not provided or is reasonably believed to have been forged or tampered with.

Any fault or damage of the product is caused by unauthorized use or modification of the product, including exposure to moisture, entry of foreign bodies (water, oil, sand, etc.) or improper installation or operation.

Product labels, serial numbers, waterproof marks, etc. show signs of tampering or alteration.

Damage is caused to the product by uncontrollable external factors, including fire, floods, high winds, or lightning strikes.

A product is not delivered to SIYI within seven (7) calendar days after Return & Refund Service confirmation is sent from SIYI.

Other circumstances stated in this policy.

### **9.2.2 15-Day Replacement**

You can request Replacement Service:

Within fifteen (15) calendar days of receiving the product if the product has sustained a substantial damage in transit, provided always that the damage proof issued by the carrier can be provided to SIYI.

Within fifteen (15) calendar days of receiving the product if the product does not match the original description of the product in one or more significant respects.

Within fifteen (15) calendar days of receiving the product if the product suffers performance failure.

Replacement Service will not be provided where:

Service is requested more than fifteen (15) calendars days after receiving a product.

Legal proof-of-purchase, receipts, or invoices are not provided, or are reasonably believed to have been forged or tampered with.

A product sent to SIYI for replacement does not include all original accessories, attachments, and packaging, or contains items damaged by user error.

A product is found to have no defects after all appropriate tests are conducted by SIYI.

Any fault or damage of the product is caused by unauthorized use or modification of the product, including exposure to moisture, entry of foreign bodies (water, oil, sand, etc.) or improper installation or operation.

Damage is caused by uncontrollable external factors, including fires, floods, high winds, or lightning strikes.

Received product has not been sent back to DJI seven (7) calendar days after replacement confirmation from DJI.

Proof of damage during transit issued by the carrier cannot be provided.

Other circumstances stated in this policy.

### 9.2.3 1-Year Warranty Repair

You can request warranty repair service:

If a product does not function as warranted during the warranty period, you may obtain after-sales service by contacting SIYI's service center. You will need to provide a valid proof-of-purchase, receipt, or order number for the warranty service.

Charges may apply for services not covered by this Limited Warranty. Please contact SIYI for information specific to your location.

Please note that the warranty service is only available in the respective SIYI service regions where you purchased your SIYI product.

Warranty Repair service will not be provided where:

Crashes or fire damage caused by non-manufacturing factors, including but not limited to pilot errors.

Damage caused by unauthorized modification, disassembly, or shell opening not in accordance with official instructions or manuals.

Damage caused by improper installation, in correct use, or operation not in accordance with official instructions or manuals.

Damage caused by non-authorized service provider.



Damage caused by unauthorized modification of circuits and mismatch or misuse of the battery and charger.

Damage caused by operation in bad weather (i.e., strong winds, rain, sand/dust storms, etc.)

Damage caused by operating the product in an environment with electromagnetic interference (i.e., in mining areas or close to radio transmission towers, high-voltage wires, substations, etc.)

Damage caused by operating the product in an environment suffering from interference from other wireless devices (i.e., transmitter, video-downlink, Wi-Fi signals, etc.)

Damage caused by reliability or compatibility issues when using unauthorized third-party parts.

Damage caused by operating the unit with a low-charged or defective battery.

Products or parts with an altered identification label or from which the identification label has been removed.

## 10 FCC STATEMENT

This device complies with Part 15 of the FCC Rules. Operation is subject to the following two conditions:

- (1) This device may not cause harmful interference, and
- (2) This device must accept any interference received, including interference that may cause undesired operation.

### **WARNING**

Changes or modifications not expressly approved by the party responsible for compliance could void the user's authority to operate the equipment.

NOTE: This equipment has been tested and found to comply with the limits for a Class B digital device, pursuant to Part 15 of the FCC Rules. These limits are designed to provide reasonable protection against harmful interference in a residential installation. This equipment generates uses and can radiate radio frequency energy and, if not installed and used in accordance with the instructions, may cause harmful interference to radio communications. However, there is no guarantee that interference will not occur in a particular installation. If this equipment does cause harmful interference to radio or television reception, which can be determined by turning the equipment off and on, the user is encouraged to try to correct the interference by one or more of the following measures:

Reorient or relocate the receiving antenna.

Increase the separation between the equipment and receiver. Connect the equipment into an outlet on a circuit different from that to which the receiver is connected.

Consult the dealer or an experienced radio/TV technician for help.

**RF Radiation Exposure Statement:**

This equipment complies with FCC radiation exposure limits set forth for an uncontrolled environment. This equipment should be installed and operated with minimum distance 20cm between the radiator & your body.

**SIYI Technology (Shenzhen) Co., Ltd**

Business Inquiry: [info@siyi.biz](mailto:info@siyi.biz)

Phone: +86 400 838 2918

AS Center: [support@siyi.biz](mailto:support@siyi.biz)