

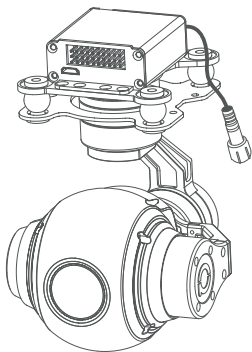

Q10F 10x Optical Zoom Gimbal Camera

User Manual

使用说明



Standard Version

标准版

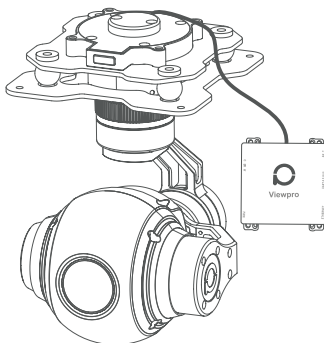

Viewport Version

快拆版



For more details please scan the QR code
or visit our website:
www.viewprotech.com

Disclaimer and Warning

Congratulations on purchasing your new Viewpro product. Please read this entire document carefully. Failure to read or follow instructions and warnings in this document may result in damage to your Viewpro product. Disassemble the gimbal camera by user is not permitted, as which may cause the camera does not work normally. Viewpro accepts no liability for damage, injury or any legal responsibility incurred directly or indirectly from the use of this project. The user shall observe safe and lawful practices including, but no limited to, those set forth in the manual.

Legends



Warning



Important Note









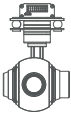
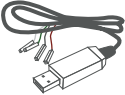

1.Product Introduction

1.1 Introduction

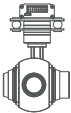
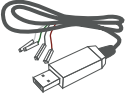
Q10F is a gimbal camera with 3 axis, 10x optical zoom lens, effective 4 megapixel. It features light and compact, metal housing and anti-interference. The 3 axis gimbal can achieve stabilization in yaw, roll and pitch. The integrated design of damping system and gimbal can greatly reduce mechanical vibration.

Q10F is widely used in UAV industries of public security, electric power, firefighting, zoom aerial photography and more.

1.2 In the Box

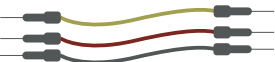
A. Standard Version			
Gimbal Camera X 1 pc		USB to TTL Cable x 1 pc	
Copper Cylinder x 4 pcs		M3 Screw x 8 pcs	
Power Cable x 1 pc			
B. Viewport Version			
Gimbal Camera X 1 pc		USB to TTL Cable x 1 pc	
Copper Cylinder x 4 pcs		M3 Screw x 8 pcs	
Power Cable x 1 pc			
PWM Control Cable x 1 pc			
TTL / S.BUS Control Cable x 1 pc			
TTL Connect Cable x 3 pcs			

2. Installation Instruction

2.1 Overview

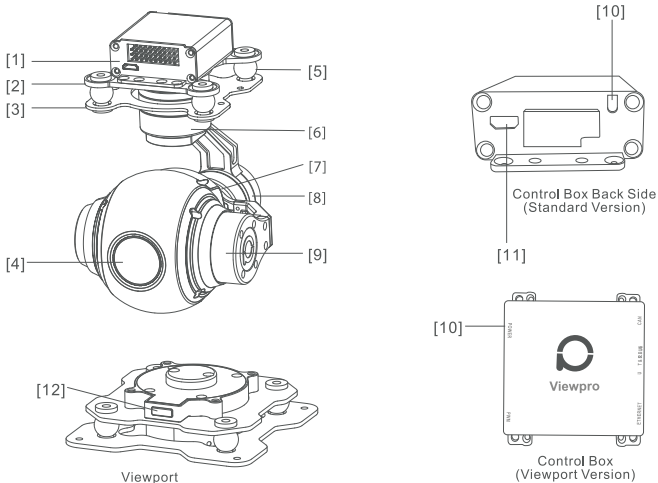

[1] Control box

[2] Upper damping board

[3] Lower damping board

[4] FHD zoom camera

[5] Damping ball

[6] Yaw axis motor

[7] TF card slot

[8] Roll axis motor

[9] Pitch axis motor

[10] 3-6S power interface

[11] Micro HDMI interface

[12] Viewport unlock button



- Please ensure that there isn't any obstacle while the motor rotating.
- Please remove the obstacle immediately if gimbal camera is blocked during rotation.

2.2.1 Control Box Printing (Standard Version)

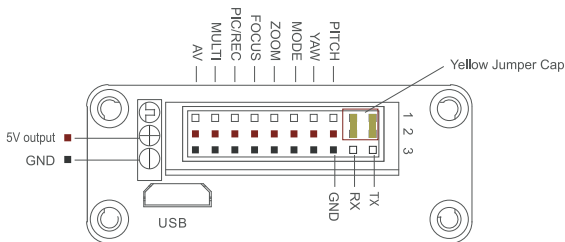

- The input voltage cannot be higher than 6S.
- The pin insertion interface cannot be connected with power supply.
- The yellow jumper cap cannot be removed

2.2.2 Control Box Printing (Viewport Version)



Front Side

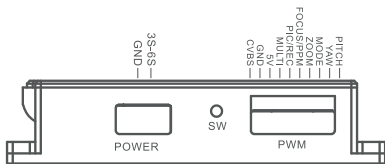

Left Side

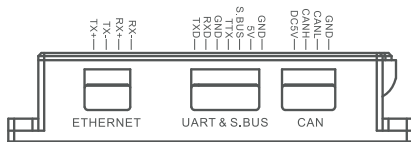

Right Side

2.3 Device Dimensions (Standard Version)

Unit: mm

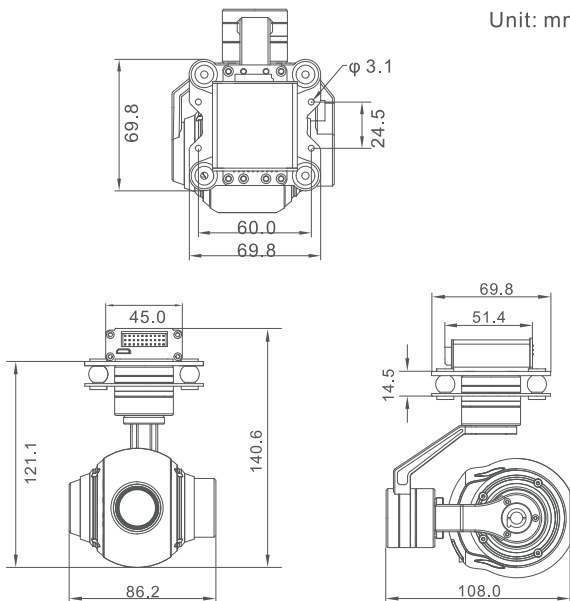

2.3 Device Dimensions (Viewport Version)

Unit: mm

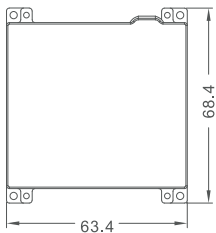
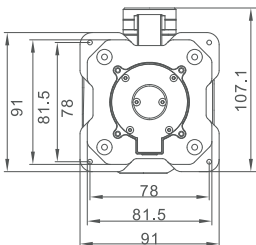

Control Box

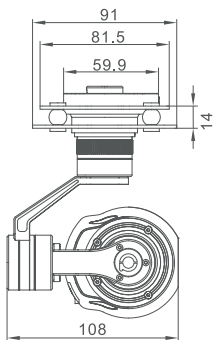
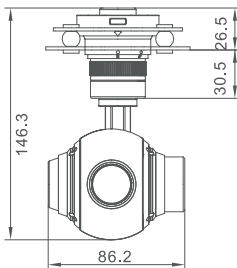

2.4 Install Mounting Part

(1) Find out the arrow on the gimbal which indicating the yaw heading of the payload (i.e. the lens direction when the camera power on), and synchronize with the direction specified by the UAV.

(2) Fix one end of the copper cylinder on the screw hole of lower damping board, and use M3 screw to fasten it.

(3) According to the provided screw hole dimension you can make suitable mounting holes on the UAV mounting board, and fixes the other end of the copper cylinder on the mounting board of the UAV (Viewport version is the same).

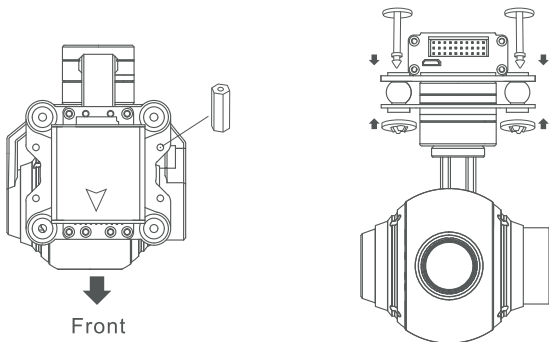

2.5 Viewport Release Instruction

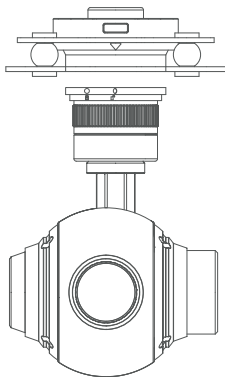

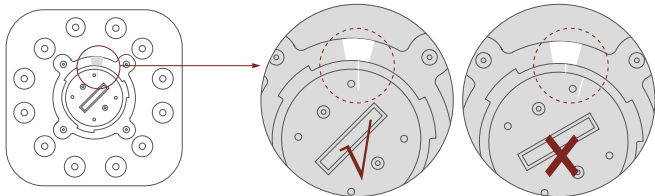

1. Make sure the two white stripes indicated above picture are aligned with each other. (If the stripes are not aligned to each other, please pinch the connector part and turn it to left manually)

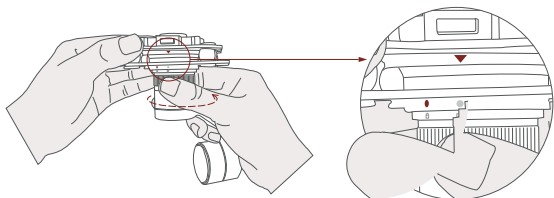

2. Align the white dot (unlock icon) to the red triangle (below unlock button), push the gimbal into the Viewport completely and then rotate the gimbal camera anticlockwise.

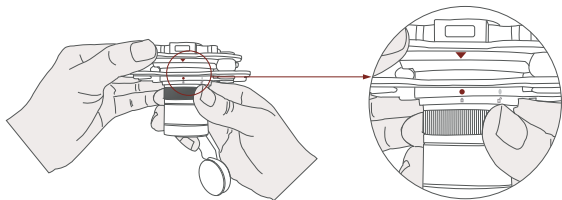

3. When you hear "click" sound (when red dot is aligned to the red triangle) means the gimbal camera and viewport has been locked.

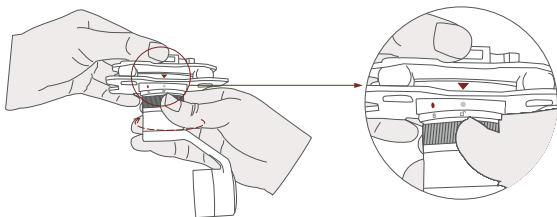

4. To unlock the Viewport, you need to press on unlock button and rotate the gimbal camera clockwise till the white dot align to the red triangle. Then pull the gimbal out from the Viewport.

2.6 Install TF Card

TF (Micro SD card): Install the TF card to the card slot (Re. 2.1.1 Overview). Support max 32GB. Request Class 10 (10m/s) transmission speed or higher and FAT32 or exFAT format.

2.7 Image Output Interface

HDMI: micro HDMI output, FHD 1080P 60fps as default

AV: analog signal output, connect with pins AV and GND (Re. 2.1 .1Overview)

3. Signal Control

3.1 PWM Control

Control the gimbal camera functions by the multiplex pulse width modulation signal outputted by PWM channel of the remote control receiver. The camera needs up to 6 control channels of PWM (to expand tracking function use up to 7 PWM channels). You can choose needed functions according to actual usage to reduce the required number of PWM channels.

3.1.1 PWM Connection Diagram (Connect pitch channel as example)

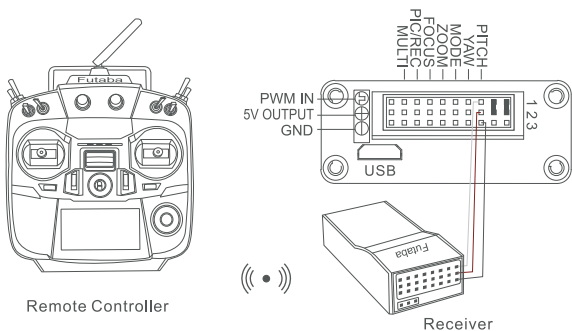

Connection Diagram Standard Version

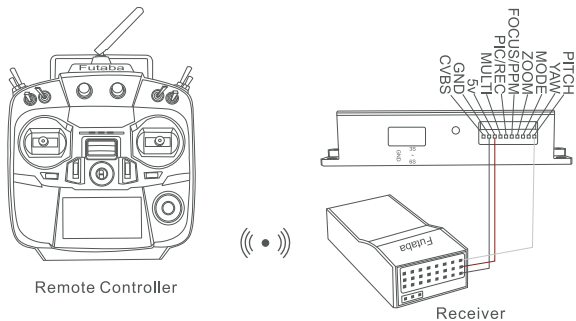

Connection Diagram Viewport Version

3.1.2 PWM Control Operation Instruction

1) Pitch (PWM Pitch channel in to control Pitch. Joystick, rotary knob or 3-gear switch on remote control are optional. 3-gear switch as example.)



Position 1

Low Gear
Pitch Up



Position 2

Middle Gear
Pitch Stop



Position 3

High Gear
Pitch Down

2) Yaw (PWM Yaw channel in to control Yaw. Joystick, rotary knob or 3-gear switch on remote control are optional. 3-gear switch as example.)



Position 1

Low Gear
Yaw Left



Position 2

Middle Gear
Yaw Stop



Position 3

High Gear
Yaw Right

3) Mode (PWM Mode channel in to adjust speed control/one key to Home position etc functions. Rotary knob or 3-gear switch on remote control are optional. 3-gear switch as example.)



Position 1

Low Gear



Position 2

Middle Gear



Position 3

High Gear

Position 1: Low speed mode, control pitch / yaw with this mode at lowest speed

Position 2: Middle speed mode, control pitch / yaw with this mode at middle speed

Position 3: High speed mode, control pitch / yaw with this mode at highest speed

(If it is controlled by rotary knob, the speed will change according to switch position)

Function of continuous switching:

3.1) Operate 1 time continuously and quickly, from position 2 - 3 - 2, to Home position.

3.2) Operate 2 times continuously and quickly, from position 2 - 3 - 2 - 3 - 2, the camera lens looks vertically down.

3.3) Operate 3 times continuously and quickly, from position 2 - 3 - 2 - 3 - 2 - 3 - 2, to disable Follow Yaw Mode (gimbal yaw not follows by frame)

3.4) Operate 4 times continuously and quickly, from position 2 - 3 - 2 - 3 - 2 - 3 - 2 - 3 - 2, to enable Follow Yaw Mode (gimbal yaw follows by frame)

3.5) Operate 5 times continuously and quickly, from position 2 - 3 - 2 - 3 - 2 - 3 - 2 - 3 - 2 - 3 - 2, to restore factory settings

4) Zoom (PWM Zoom channel in to control Zoom. Joystick, rotary knob or 3-gear switch on remote control are optional. 3-gear switch as example.)



Position 1

Low Gear
Zoom Out



Position 2

Middle Gear
Stop Zoom



Position 3

High Gear
Zoom In

5) Focus (PWM Focus channel in to control Manual Focus, default auto-focus mode. 3-gear switch on remote control are optional. 3-gear switch as example.)



Position 1

Low Gear
Focus Tele



Position 2

Middle Gear
Stop Focus



Position 3

High Gear
Focus Near

6) Pic/Rec (PWM Pic/Rec channel in to control take picture and record. Joystick, rotary knob or 3-gear switch on remote control are optional. 3-gear switch as example.)



Position 1

Low Gear



Position 2

Middle Gear



Position 3

High Gear

Switch from Position 2 to 1:

Photograph / Record:

- Picture mode: from 2 to 1, take a picture
- Record mode: from 2 to 1, start record, repeat operation to stop record

Switch from Position 2 to 3:

Picture / Record Mode Switch

- Picture mode: the number is picture quantity that SD card can store.
- Record mode: the time is recording time.

7) **Multi**: backup PWM channel, no control

3.2 Serial Port / TTL Control

TTL communication requirements: TTL signal is 3.3V, baud rate: 115200, data bit 8, stop bit 1, no parity, HEX send and receive.

Connection Diagram (PC - USB to TTL Cable- Gimbal Camera as example):

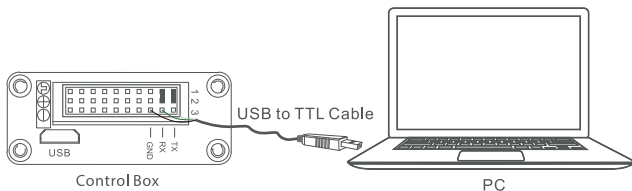
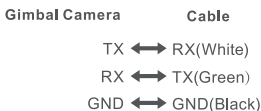

Connection Diagram Standard Version

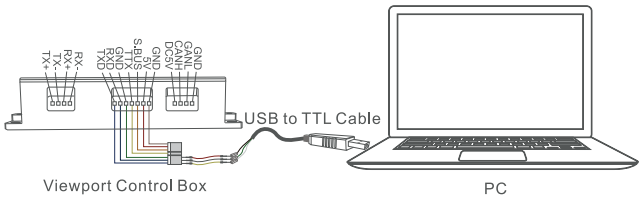

Connection Diagram Viewport Version

Diagram of USB to TTL Cable:

Connect the camera to the upper computer by USB to TTL cable (Adopt connection method of TX to RX, RX to TX, GNG to GND at Dupont ends of the provided USB to TTL cable, connect to the specified TTL of the gimbal, and the USB end of the cable connect to computer).

Install Viewlink control software to test the functions directly. Users may choose to develop their own software, please contact technical support for TTL control protocol file.

ViewLink is a user interface developed by Viewpro for Viewpro gimbal cameras, you can download it from Viewpro website (www.viewprotech.com) or ask distributors for installation package.



- Connect serial port of gimbal to pins, DO NOT connect with power supply.



- The default baud rate of serial port is 115200, which can be changed according to the docking equipment.

3.3 S.BUS Control

Control the gimbal camera functions by one combining signals. Connect the external S.Bus to S.Bus port on the control box, and the external S.bus signal GND connect to the GND interface of the control box.

Wiring Diagram (Take Futaba remote control as example):

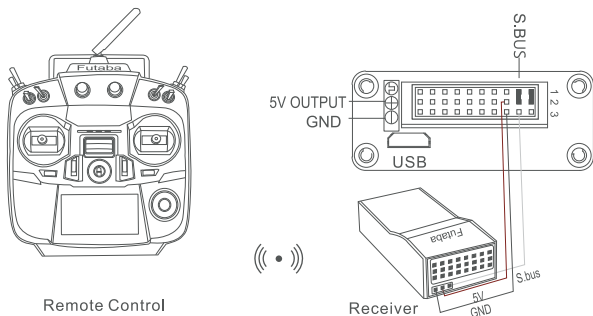

Wiring Diagram Standard Version

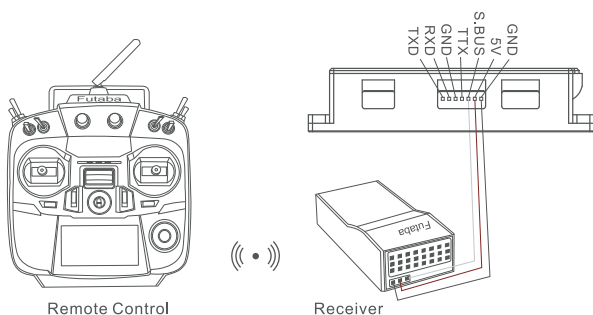

Wiring Diagram Viewport Version

S.Bus control mode: default S.Bus signal channel 9-15 to control gimbal camera functions (the function of channel is consistent with corresponding channel in PWM function description)

Channel 9: Yaw Control

Channel 10: Pitch Control

Channel 11: Mode Control

Channel 12: Zoom Control

Channel 13: Focus Control

Channel 14: Pic/Rec Control

Channel 15: Multi Backup



• TTL control and S.bus control cannot coexist at the same time for standard version. The default control is TTL if no requirement. The user can set to S.bus control if needed (please contact with our technical support for the setting instruction.)

4. Specification

General	
Dimensions	86.2*108*140.6mm (Standard Version) 86.2*108*146.3mm (Viewport Version)
Net Weight	431g (Standard Version) 532g (Viewport Version)
Input Voltage	3S-6S (12V-24V)
Working Voltage	12V
Idle Current	250mA
Working Environment Temp	-20 to 60 °C
Gimbal	
Angular Vibration Range	±0.02°
Mount	Non-detachable / Detachable
Controllable Range	Yaw: ±290°, Pitch: -45°~90°
Mechanical Range	Yaw: ±300°, Pitch: ±105°, Roll: ±70°
Max Controllable Speed	Yaw: 300°/s, Pitch: 300°/s
Camera	
Sensor	CMOS: 1/3 inch, Effective Pixels:4MP

Lens	10x optical zoom
FOV	66.6°~7.2°
Focal Length	F=4.9~49mm
Min Focus Distance	1.5m
Digital Zoom	None
Photo Format	JPG
Video Format	MOV
Working Modes	Capture, Record
HD output	1080P30/60fps (default)
AV output	Standard CVBS
Exposure mode	Auto
Exposure Compensation	±2.0 (1/3 steps)
Shutter speed	Auto
Defog	Not Support
White Balance	Auto
Anti flicker	50Hz~60Hz
Day/night switch	Color / Black and white mode
Pal Ntsc TV system	Supported
Local-storage	Micro SD card
Supported File System	FAT32(≤ 32 GB)

5. FAQ

1.What outputs that Q10F supports?

A: HDMI 1080p 60fps(default) / HDMI 1080p 30fps, compatible with analog output.

2.Q10F cannot store pictures and videos?

A: Please make sure a TF card should be put into the specified card slot in the camera, and the standard of TF card is selected correctly. (Requirements: max capacity of 32G, class10 and above transmission speed, FAT32 or ex FAT format). If there are still problems, please format the TF card.

3.Does Q10F support taking photos during recording?

A: No, not support. Q10F has photo mode and record mode. You need to switch to photo mode to take picture.

4. What is the focusing mode of Q10F?

A: The camera can auto focus or manually.