

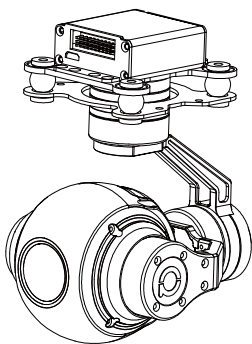

QIR19 19mm Single ThermalGimbal Camera User Manual

User Manual

使用说明



Standard Version

标准版

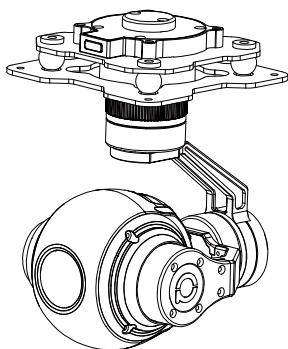

Viewport Version

快拆版



For more details please scan the QR code
or visit our website:

www.viewprotech.com

Disclaimer and Warning

Congratulations on purchasing your new Viewpro product. Please read this entire document carefully. Failure to read or follow instructions and warnings in this document may result in damage to your Viewpro product. Disassemble the gimbal camera by user is not permitted, as which may cause the camera does not work normally. Viewpro accepts no liability for damage, injury or any legal responsibility incurred directly or indirectly from the use of this project. The user shall observe safe and lawful practices including, but no limited to, those set forth in the manual.

Legends



Warning



Important Note









1.Product Introduction

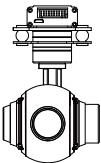
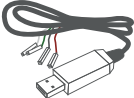

1.1 Introduction

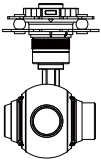
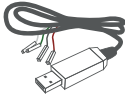
QIR19 is a high-precision 3-axis gimbal integrated with a 19mm lens 640*480 IR thermal sensor, supports 1x ~ 4x digital zoom. It supports IR thermal image switch, IR color palette switch, photographing and video, target tracking and thermal digital zoom. OSD can display angle, digital zoom times, status of record and picture mode, tracking frame, also can select to turn off the OSD. When the external GPS and time input, GPS coordinate and shooting time can be saved in image file, OSD can display GPS and real-time as well. The 3 axis gimbal can achieve stabilization in yaw, roll and pitch. The integrated design of damping system and gimbal can greatly reduce mechanical vibration.

QIR19 is widely used in UAV industries of public security, electric power, fire fighting, zoom aerial photography and other industrial applications.

1.2 In the Box

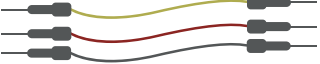
A. Standard Version			
Gimbal Camera x 1 pc		USB to TTL Cable x 1 pc	
Copper Cylinder x 4 pcs		M3 Screw x 8 pcs	
Power Cable x 1 pc			
B. Viewport Version			
Gimbal Camera x 1 pc		USB to TTL Cable x 1 pc	
Copper Cylinder x 4 pcs		M3 Screw x 8 pcs	
Power Cable x 1 pc			
PWM Control Cable x 1 pc			

TTL / S.BUS Control Cable x 1 pc	
TTL Connect Cable x 3 pcs	
Ethernet Cable x 1 pc	

2. Installation Instruction

2.1 Overview

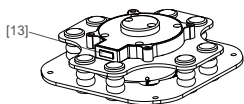
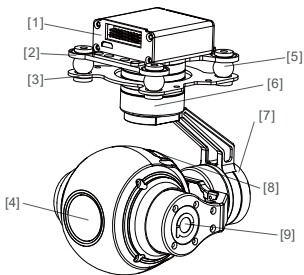

Viewport

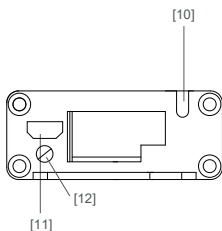

Control Box Back Side
(Standard Version)

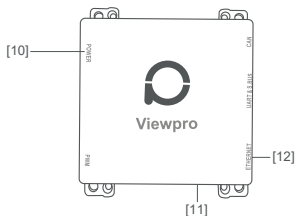

(Viewport Version)

- [1] Control box
- [2] Upper damping board
- [3] Lower damping board
- [4] Infrared thermal camera
- [5] Damping ball
- [6] Yaw axis motor
- [7] Roll axis motor
- [8] TF card slot
- [9] Pitch axis motor
- [10] 3-6S power interface
- [11] Micro HDMI interface
- [12] Ethernet interface
- [13] Viewport unlock button



- Please ensure that there isn't any obstacle while the motor rotating.
- Please remove the obstacle immediately if gimbal camera is blocked during rotation.



- Don't put the infrared thermal camera towards the sun in case any burn to the camera

2.2.1 Control Box Printing (Standard Version)

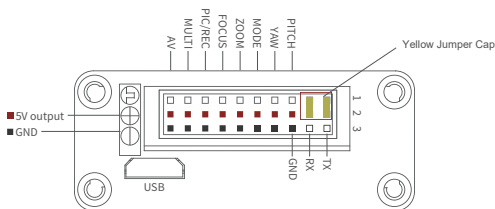

- The input voltage cannot be higher than 6S.
- The pin insertion interface cannot be connected with power supply.
- The yellow jumper cap cannot be removed

2.2.2 Control Box Printing (Viewport Version)



Front Side

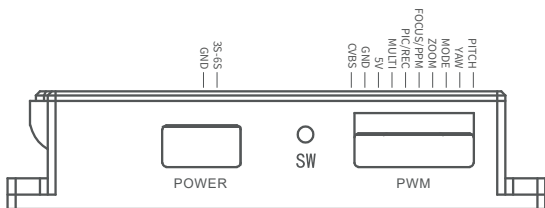

Left Side

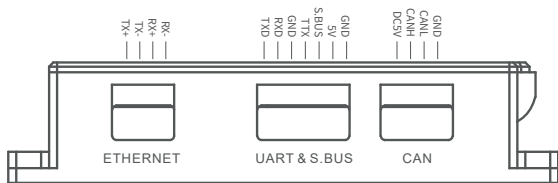

Right Side

2.3 Device Dimensions (Standard Version)

Unit: mm

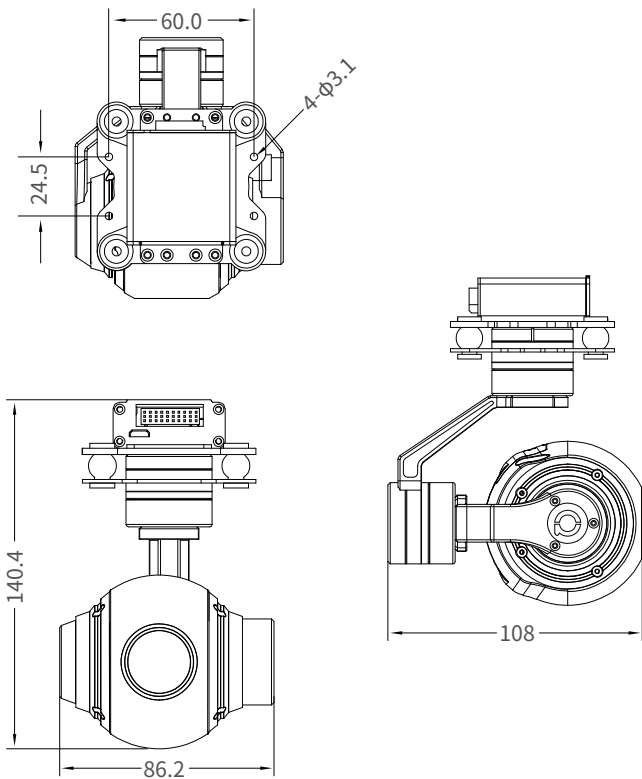

2.3 Device Dimensions (Viewport Version)

Unit: mm

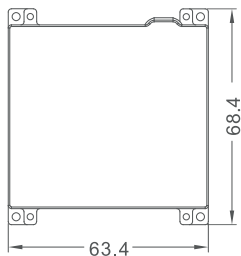
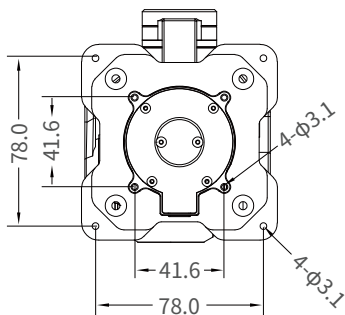

Control Box

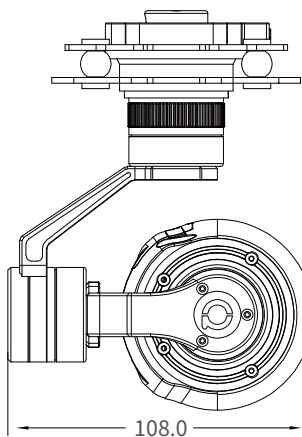
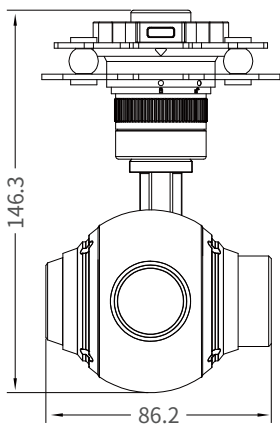

2.4 Install Mounting Part

(1) Find out the arrow on the gimbal which indicating the yaw heading of the payload (i.e. the lens direction when the camera power on), and synchronize with the direction specified by the UAV.

(2) Fix one end of the copper cylinder on the screw hole of lower damping board, and use M3 screw to fasten it.

(3) According to the provided screw hole dimension you can make suitable mounting holes on the UAV mounting board, and fixes the other end of the copper cylinder on the mounting board of the UAV (Viewport version is the same).

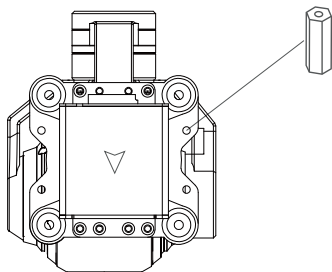

Front

2.5 Viewport Release Instruction

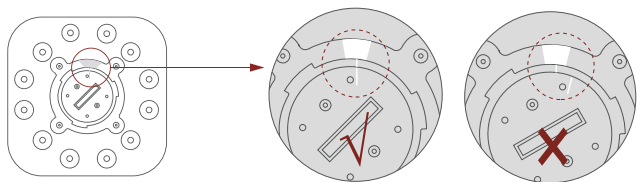
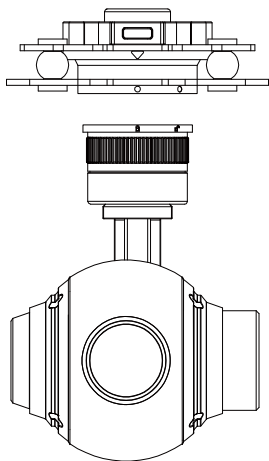

1. Make sure the two white stripes indicated in above picture are aligned with each other. (If the stripes are not aligned to each other, please pinch the connector part and turn it to left manually)

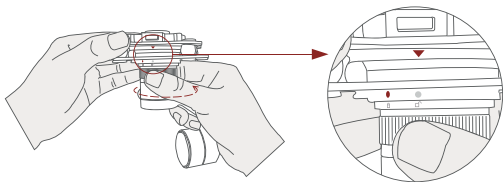

2. Align the white dot (unlock icon) to the red triangle (below unlock button), push the gimbal into the Viewport completely and then rotate the gimbal camera anticlockwise.

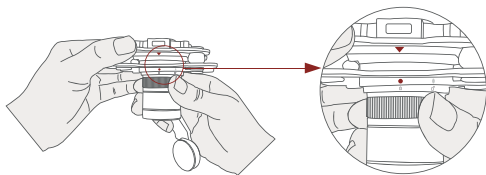

3. When you hear "click" sound (when red dot is aligned to the red triangle) means the gimbal camera and Viewport has been locked.

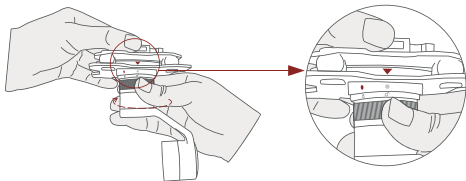

4. To unlock the Viewport, you need to press on unlock button and rotate the gimbal camera clockwise till the white dot align to the red triangle. Then pull the gimbal out from the Viewport.

2.6 Install TF Card

TF (Micro SD card): Install the TF card to the card slot (Re. 2.1 Overview). Support max 128GB. Request Class 10 (10m/s) transmission speed or higher and FAT32 or exFAT format.



- Make sure device is power off when inserting the TF card, hot plugging is not supported.
-

2.7 Image Output Interface

HDMI: micro HDMI output, HD 1080P 60/50/30/25fps, 1080P 60fps as default. (Optional)

Network: Ethernet output interface, support RTSP/RTMP/UDP/ONVIF video streaming. Default: RTSP output, IP address: RTSP://192.168.2.119:554, output resolution: 720P (record in 1080p), frame rate: 25fps, bit rate: 2M. (Optional)

SDI: SMA outer screw inner hole interface, 1080P 30fps output. (Optional)

AV: no AV output

-
- Above output mode is optional, HDMI and SDI output cannot coexist at the same time. Please subject to your actual product.



- When using user interface software Viewlink for network connection, the network of external device (computer) should be the IP address: 192.168.2.2 (choose the last byte among 2~254, can not be 119 same as the gimbal), subnet mask: 255.255.255.0, Default gateway: 192.168.2.1, and all firewalls of the computer must be closed. Then enter the IP address of the gimbal camera, Open Video, the video stream can be outputted.
-

3. Signal Control

3.1 PWM Control

Control the gimbal camera functions by the multiplex pulse width modulation signal outputted by PWM channel of the remote control receiver. The camera needs up to 6 control channels of PWM (to expand tracking function use up to 7 PWM channels). You can choose needed functions according to actual usage to reduce the required number of PWM channels.

3.1.1 PWM Connection Diagram (Connect pitch channel as example)

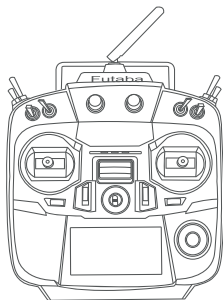

Remote Controller

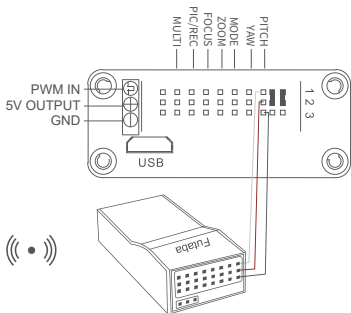

Receiver

Connection Diagram (Standard Version)



Remote Controller

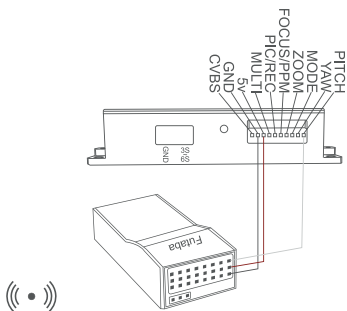

Receiver

Connection Diagram (Viewport Version)

3.1.2 PWM Control Operation Instruction

1) Pitch (PWM Pitch channel in to control Pitch. Joystick, rotary knob or 3-gear switch on remote control are optional. 3-gear switch as example.)



Position 1

Low Gear
Pitch Up



Position 2

Middle Gear
Pitch Stop



Position 3

High Gear
Pitch Down

2) Yaw (PWM Yaw channel in to control Yaw. Joystick, rotary knob or 3-gear switch on remote control are optional. 3-gear switch as example.)



Position 1

Low Gear
Yaw Left



Position 2

Middle Gear
Yaw Stop



Position 3

High Gear
Yaw Right

3) Mode (PWM Mode channel in to adjust speed control/one key to Home position etc functions. Rotary knob or 3-gear switch on remote control are optional. 3-gear switch as example.)



Position 1

Low Gear



Position 2

Middle Gear



Position 3

High Gear

Position 1: Low speed mode, control pitch / yaw with this mode at lowest speed

Position 2: Middle speed mode, control pitch / yaw with this mode at middle speed

Position 3: High speed mode, control pitch / yaw with this mode at highest speed

(If it is controlled by rotary knob, the speed will change according to switch position)

Function of continuous switching:

3.1) Operate 1 time continuously and quickly, from position 2 - 3 - 2, to Home position.

3.2) Operate 2 times continuously and quickly, from position 2 - 3 - 2 - 3 - 2, the camera lens looks vertically down.

3.3) Operate 3 times continuously and quickly, from position 2 - 3 - 2 - 3 - 2 - 3 - 2, to disable Follow Yaw Mode (gimbal yaw not follows by frame)

3.4) Operate 4 times continuously and quickly, from position 2 - 3 - 2 - 3 - 2 - 3 - 2 - 3 - 2, to enable Follow Yaw Mode (gimbal yaw follows by frame)

4) Zoom (PWM Zoom channel in to control Zoom. Joystick, rotary knob or 3-gear switch on remote control are optional. 3-gear switch as example.)



Position 1

Low Gear
IR digital zoom



Position 2

Middle Gear
No control



Position 3

High Gear
IR color palette switch

Switch from Position 2 to 1: IR color switching: white hot, black hot, pseudo color.

Switch from Position 2 to 3: IR digital zoom: 3x, 6x, 9x, 12x.

5) Focus (PWM Focus channel is to control IR color palette switch. 3-gear switch as example.)



Position 1

Low Gear
No control



Position 2

Middle Gear
No control



Position 3

High Gear
IR color palette switch

Switch from Position 2 to 3: IR color switching: white hot, black hot, pseudo color.

6) Pic/Rec (PWM Pic/Rec channel in to control take picture and record. Joystick, rotary knob or 3-gear switch on remote control are optional. 3-gear switch as example.)



Position 1

Low Gear



Position 2

Middle Gear



Position 3

High Gear

Switch from Position 2 to 1: Take a picture

- OSD display 'REC IMG' a second.

Switch from Position 2 to 3: Start record / repeat operation to stop record

- Start record, the OSD display rec hh:mm:ss.
- Stop record, the OSD display STBY.

7) Multi: tracking control



Position 1

Low Gear



Position 2

Middle Gear



Position 3

High Gear

Switch from Position 2 to 1: Cancel tracking

Switch from Position 2 to 3:

- Exit the tracking, display the lock frame in the center of the screen, start tracking

Switch from Position 3 to 2:

- "+" appears in the center of the screen, adjust the cross cursor UDLR with yaw and pitch control to lock target object

Switch from Position 2 to 3 again:

- Choose another target for second tracking

3.2 Serial Port / TTL Control

TTL communication requirements: TTL signal is 3.3V, baud rate: 115200, data bit 8, stop bit 1, no parity, HEX send and receive.

Connection Diagram (PC - USB to TTL Cable- Gimbal Camera as example):

Gimbal Camera	Cable
TX	↔ RX (White)
RX	↔ TX (Green)
GND	↔ GND (Black)

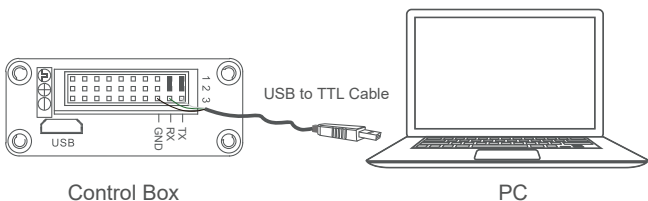

Connection Diagram Standard Version

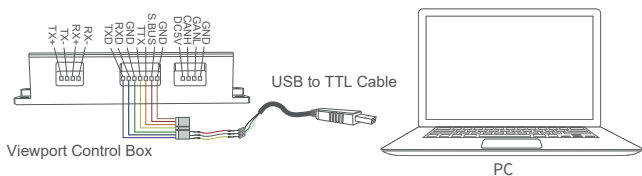

Connection Diagram Viewport Version

Diagram of USB to TTL Cable:

Connect the camera to the upper computer by USB to TTL cable (Adopt connection method of TX to RX, RX to TX, GNG to GND at Dupont ends of the provided USB to TTL cable, connect to the specified TTL of the gimbal, and the USB end of the cable connect to computer).

Install Viewlink control software to test the functions directly. Users may choose to develop their own software, please contact technical support for TTL control protocol file.

ViewLink is a user interface developed by Viewpro for Viewpro gimbal cameras, you can download it from Viewpro website (www.viewpro-tech.com) or ask distributors for installation package.



- Connect serial port of gimbal to pins, DO NOT connect with power supply.



- The default baud rate of serial port is 115200, which can be changed according to the docking equipment.
-

3.3 S.BUS Control

Control the gimbal camera functions by one combining signals. Connect the external S.Bus to S.Bus port on the control box, and the external S.bus signal GND connect to the GND interface of the control box.

Wiring Diagram (Take Futaba remote control for example):

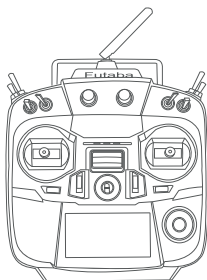

Remote Control

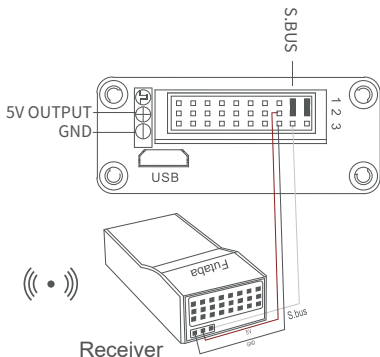

Wiring Diagram Standard Version

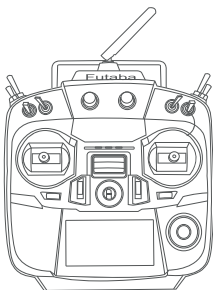

Remote Control

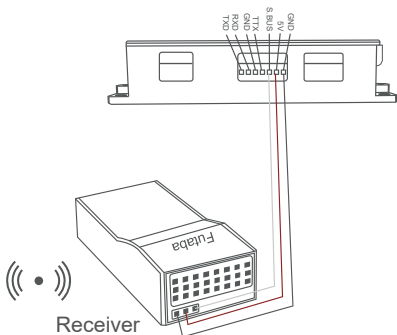

Wiring Diagram Viewport Version

S.Bus control mode: default S.Bus signal channel 9-15 to control gimbal camera functions (the function of channel is consistent with corresponding channel in PWM function description)

Channel 9: Yaw Control

Channel 10: Pitch Control

Channel 11: Mode Control

Channel 12: Zoom Control

Channel 13: Focus Control

Channel 14: Pic/Rec Control

Channel 15: Multi Backup



- User can set the channels by setting serial command according to the actual requirement. The S.Bus channel position can be arranged in any sequence within channel 1-15 to connect with the flight controller or remote control.

- TTL control and S.bus control cannot coexist at the same time for standard version. The default control is TTL if no requirement. The user can set to S.bus control if needed (please contact with our technical support for the setting instruction.)

3.4 TCP control

For Viewpro gimbal cameras with Ethernet output, the default IP address is: 192.168.2.119, control port: 2000. You can send the corresponding protocol to realize TCP control after connecting.

The TCP control protocol is [Frame header: EB + command ID: 90 + data body (serial port protocol) + Checksum (CS = body checksum, checksum is calculated as a sum of all bytes of data body modulo 256)]. Or directly use UI Viewlink to control after TCP connection.

4. Specification

Hardware Parameter	
Working voltage	12V
Input voltage	3S ~ 6S(12V~24V)
Dynamic current	400mA @ 12V
Idle current	300mA @ 12V
Working environment temp	-20℃ ~ +60℃
Output	micro HDMI 576i 50fps / AV
Local-storage	SD card (Up to 128G, class 10, FAT32 or ex FAT format)
Control method	PWM / TTL / S.BUS
Gimbal Spec	
Angle range of structure design	Pitch/Tilt: $\pm 100^\circ$, Roll: $\pm 70^\circ$, Yaw/Pan: $\pm 300^\circ$
Angle range of software design	Pitch/Tilt: $-45^\circ \sim 90^\circ$, Yaw/Pan: $\pm 290^\circ$
Vibration angle	Pitch/Roll: $\pm 0.02^\circ$, Yaw: $\pm 0.02^\circ$
One-key to center	√

Thermal Imager Spec

Lens size	19mm
Horizontal FOV	32°
Vertical FOV	24°
Diagonal FOV	39.4°
Detective Distance (Man: 1.8x0.5m)	559 meters
Recognize Distance (Man: 1.8x0.5m)	140 meters
Verified Distance (Man: 1.8x0.5m)	70 meters
Detective Distance (Car: 4.2x1.8m)	1714 meters
Recognize Distance (Car: 4.2x1.8m)	428 meters
Verified Distance (Car: 4.2x1.8m)	214 meters
Working mode	Uncooled long wave (8 μ m~14 μ m) thermal imager
Photo storage format	JPG(704*576)
Video storage format	AVI (704*576 25fps)
Detector pixel	640*480
Pixel size	17 μ m

Focusing method	Prime lens
NETD	≤60mK (@30℃)
Image enhancement	Digital image details enhancement technology, 2 enhancement mode
Color palette	Outline-drawing, white hot, black red, green blue yellow red, ect. 12 color palette
Auto Non-uniform correction	Digital thermal image correction technology
Digital zoom	1x ~ 4x
Sync correct time	Yes
Thermometry type	Optional: max temp, min temp, FOV center temp, average temp
Temperature warning	Optional: overheat warning
Packing Information	
N.W.	440g
Product meas.	105*91*98mm
Accessories	1pc gimbal device, 8pcs screws, 4pcs copper cylinders, 4pcs damping balls, 1set damping board / box

5. FAQ

1. Does QIR19 support taking photos during recording?

A: Yes.

2. How to set the storage format of QIR19?

A: When the IP output resolution is set to 1280*720, the storage resolution is 1920 * 1080; Storage resolution is 1280 * 720 when the IP output resolution is set to 1920*1080; The video frame rate saved in the TF card is the same with the one set during IP output. The frame rate is 25fps or 30fps for optional.

3. Does QIR19 support simultaneous TCP control for multiple devices?

A: Yes