

# **SKYDROID 云卓**

Quanzhou Skydroid Technology Co., Ltd.



## **SKYDROID-H16/H16 PRO**

User Manual V1.0

# Contents

<b>A.Overview</b>	3
Product Features	3
Main purpose and scope of application	3
Specifications	3
The composition of the model and its significance	4
Port definition	6
Environment conditions	6
Working conditions	6
Safety	6
<b>B.Operation</b>	7
Preparation and pre-checking before use	7
Operation	7
Part 1: Language setting	7
Part 2: Status	8
Part 3: H16 Helper	8
Part 4: Binding operation	9
Part 5: Video/Image connection and settings	9
Part 6: How to show video & data transmission and telemetry	10
Part 7: How to connect the internet	10
Part 8: How to share internet, video/image transmission and	12
Part 9: Master&Slave controlling mode,coach mode and student mode	15
Part 10: Q & A	
<b>C.Maintenance, servicing</b>	16
<b>D.Transportation and storage</b>	16
<b>E.Others</b>	16

## ATTENTION

This product uses the following terms to classify the potential hazards that may be caused by improper operation.

**Note:** If not follow the instructions, it may cause property damage and minor injuries.

**Note:** If not follow the instructions, it may cause property damage, major accidents and serious injuries.

**Warning:** Misuse of this product may result in injury, damage or loss of property. Read the manual carefully before using this product. This item is not a toy. This item is intended for use by professional UAV operators and installers only. Do not use this product if you lack the knowledge and expertise to install and maintain UAV radio equipment. Do not use unapproved or unofficial components with this system. Operators must strictly follow the operation guides set forth in this manual. Skydroid does not accept any liability for the use or misuse of this product.

## A. Overview

### 1. Product Features

① The H16 series uses the newest surging processor, equipped with an Android embedded system and advanced SDR technology, also with a super protocol stack to make the image clearer, lower latency, longer distance transmission, and stronger anti-interference. Wildly applied for drones, Robots, industrial controlled equipment, etc.

② Supports rich interfaces such as HDMI, RJ45, sensor interface, dual serial ports passthrough transmission, SBUS, aerial photography, FPV security, fire protection, power, mapping robot, border control, etc.

③ IP67 design, based on waterproof, dust free and drop-resistant materials and structure to ensure its great using feel and durability.

④ H16 uses 7-inch FHD high-brightness display, 1800 nits brightness IPS LCD screen, which can be viewed clearly under the sun. Supports 1080P high-definition digital image transmission. The dual-antenna signals complement each other, with super-strong signals and ultra-long transmitting distances, combined with algorithm control and out-of-step frequency hopping algorithms, greatly increasing the ability to communicate with weak signals. So you don't need to worry about the flight distance during flight operations, just explore a wider scenery. H16's video transmission distance is around 5-10km, H16 Pro's video transmission distance is around 20-30KM.

⑤ Integrated with high energy density lithium ion battery, 18w fast charging, can work for 8-15 hours after 2 hours of charging. The consistent survival thinking in the wilderness allows you to have no concerns about the reliability of our equipment.

⑥ H16/H16 Pro supports rich interfaces such as HDMI, RJ45, sensor interface, dual serial port passthrough transmission, SBUS, etc. And supports many brands cameras, pan-tilts, pods and other video equipment. Provide development kit, SDK and technical support, support video suspension, support ground station of mainstream flight control, support QGC and wireless RTSP video stream sharing.

⑦ The use of weather silica gel, frosted rubber, stainless steel, and aviation aluminum alloy makes the extreme operating feel, and also meets the harsh conditions of outdoor use of drones. H16 is dust-free and waterproof in the fuselage, control switches, and various peripheral interfaces. Protective measures such as splashing can ensure stable and smooth operation of the equipment in harsh environments.

⑧ Rich ground-end interface, Coach PPM input + output, RJ45 network interface, long-distance connection to the internal network, Type-C Android high speed USB interface, OTG interface can be connected to U disk and network card, etc., expanded TF card slot.

⑨ An independent 2-dimensional gimbal joystick makes the gimbal flying with great facility, like a duck to water.

### 2. Main purpose and scope of application

It is used to remotely operate helicopters, fixed wings, multi-rotors, vehicles, ships, etc. for video image transmission (optional camera), data transmission, and control drone flight.

### 3. Specifications

#### PRODUCT DATA

Remote Controller Specification			
Model No.	H16/H16 PRO	Channels	16
Working voltage	4.2V	RF Power	20DB@CE/23DB@FCC
Frequency	2.400-2.483GHz	Frequency hopping	Newest FHSS
Update way	APP Update online	Weight	1034g
Size	272*183*94mm	Battery	20000mA/H
Endurance	6-20 Hrs	Charging port	TYPE-C
Applications	Helicopter, fixed wing, multi-rotor, unmanned vehicle, unmanned boat, etc.		

Receiver Specification			
Model No.	R16	Channels	16
Working Voltage	7.2-72V	RF Power	20DB@CE/23DB@FCC
Size	76*69*11mm	Weight	90g

MIPI Night Camera Specification			
Model No.	MIPI	Working current (light on)	140mA
Working voltage	14-72V	Working current (light off)	14mA
Size	102.1*42.6*36.5mm	Weight	55g

**4.The composition of the model and its significance**

H16/H16 PRO Controller

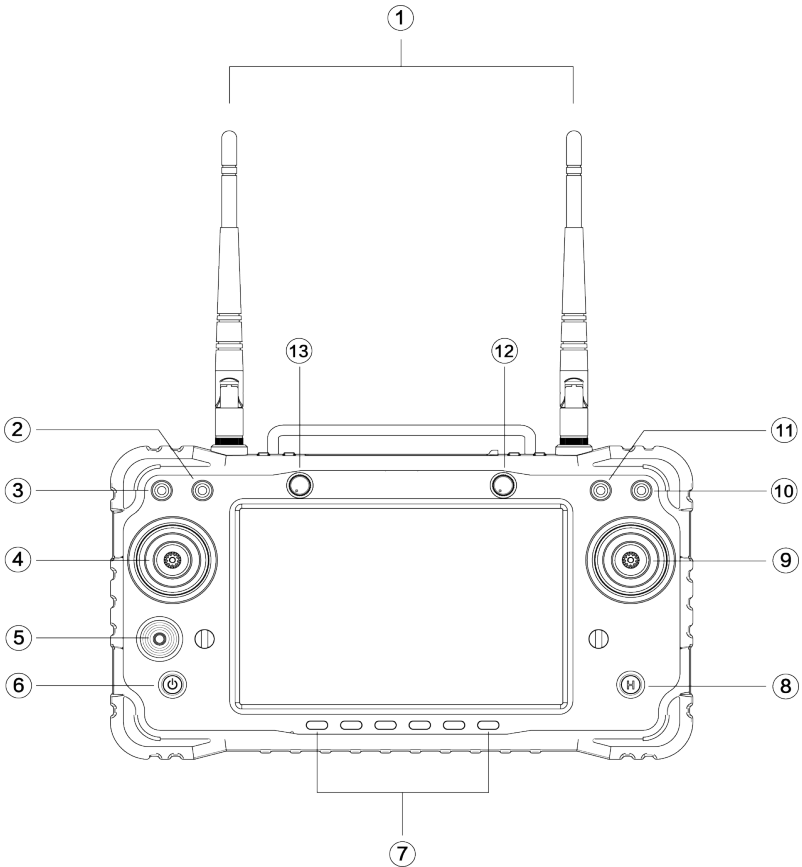

### Number Description

Number	Annotation	Number	Annotation
1	2.4G 3dB antenna	10	Toggle 3 positions switcher SW4
2	Toggle 3 positions switcher SW2	11	Toggle 3 positions switcher SW3
3	Toggle 3 positions switcher SW1	12	Knob AUX2
4	Left stick X1. Y1	13	Knob AUX1
5	Little stick X3. Y3		
6	Power switcher		
7	6 positions switcher		
8	Key button ( default camera's LED power switch)		
9	Right stick X2. Y2		

### Receiver

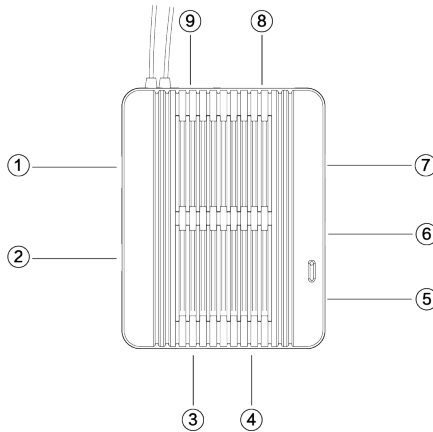
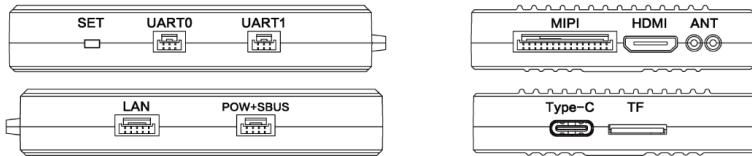

Number	Annotation	Number	Annotation
1	Network port	6	Uart 0
2	Power and Sbus input	7	Uart 1
3	Type-C	8	MIPI port
4	TF slot	9	HDMI input
5	Button for binding		

## 5.Port definition

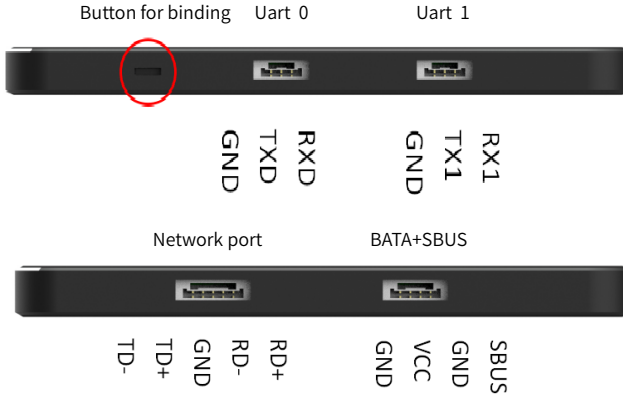

## 6.Environment conditions

### Pay attention

- A) Working temperature:-10°C~+55°C
- B) Storage temperature:-25°C~+70°C
- C) Relative humidity:Not exceed 85%
- D) Atmospheric pressure:86kPa~106kPa
- E) Working environment should not contain explosive material or any corrosive or harmful gas may cause interference in the operation of the product.
- F) Always work under shelter to prevent rain, snow, wind, sand and dust contamination.

## 7.Working conditions

### Power supply and attentions

H16 series uses a built in Li-ion battery. Charging port is compatible with common Type-C 9V-2A chargers (such as cell phone, digital cameras' USB charger).

In case of smoke, heat or unusual smell during charging, please stop charging immediately and return to our company for servicing as soon as possible.

Do not leave the product unattended while charging. Do not leave the product in a place where children can reach. Do not charge when room temperature over 60 °C.

## 8.Safety

### Warning

Beginners should pay attention for the followings! Please read it carefully!

- ⊗ DO NOT fly under the influence of substances, or when tired!
- ⊗ DO NOT fly in strong wind and or rainy conditions!
- ⊗ DO NOT fly close to electric emission towers, communication stations and crowded area!
- ⊗ DO NOT fly nearby airports and other prohibited areas!
- ⊗ DO NOT fly around people or animals, or in any location where possible to damage property.
- ⚠ Check equipment before every flight and check whether the transceiver system and the aircraft are normal or not.
- ⚠ Please use certified chargers to charge the batteries.
- ⚠ DO NOT put unnecessary force on antennas since its weakness.

## B.Operation

### 1.Preparation and pre-checking before use

**Pay attention**

- ① Check battery level.
- ② Check position of the antenna to get the best performance.
- ③ Make sure the firmware is the latest version.
- ④ DO NOT operate under the influence of alcohol or drugs.

### 2.Operation

#### Part 1: Language setting

- ① Enter system setting, choose your language and input method.



- ② Once entering language and input method choosing, you can add/cancel/choose the language you want

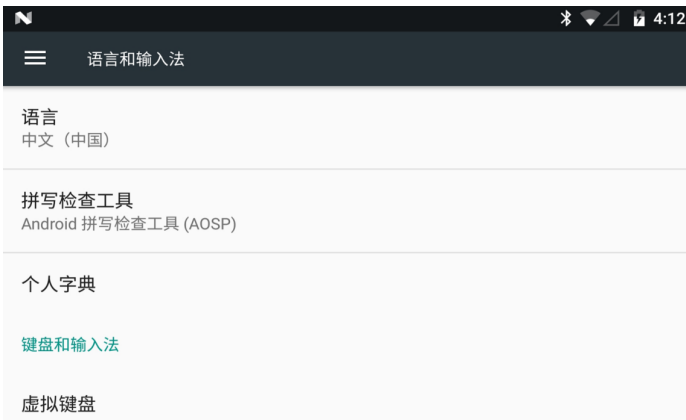

## Part 2: Status



- ① Icon for connecting internet by network port or USB.
- ② Icon for connecting well between the TX and RX (icon in picture shows no connecting with RX).
- ③ Icon for Power level.
- ④ Icon for Time.
- ⑤ Icon for return.
- ⑥ Icon for back home.
- ⑦ Icon for back ground management/screen splitter.

## Part 3: H16 Helper



- ① Switch the joystick operation mode of the remote control.
- ② Check whether the value of each channel of the remote control is normal or not.
- ③ You can view MIPI, HDMI, UART VIDEO and other RTSP videos (details are described below).
- ④ Binding the remote control with other receivers (the binding method is introduced below)..
- ⑤ In the advanced parameters setting part, you can adjust the channel, upgrade the joystick firmware, and modify the receiver's serial port baud rate (password 999, it is only for professional debugging).



## Part 4: Binding operation

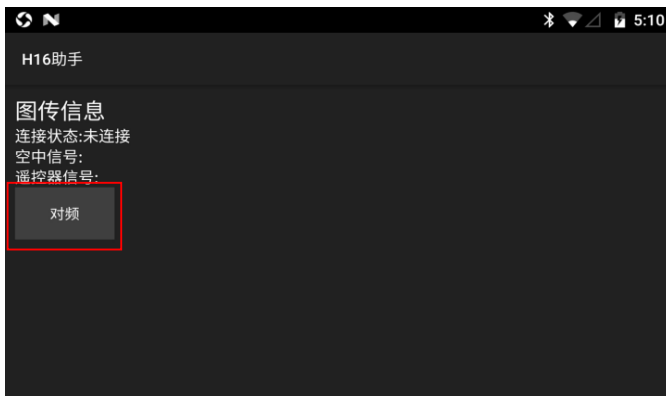

- ① After powering on the receiver, wait 3-5 seconds, then press and hold the receiver "SET", and release "SET" when the white light flashes.
- ② Enter the H16 helper, click on the "binding", click on the "binding" (after the binding is successful, it will show "connected").

## Part 5: Video/Image connection and settings

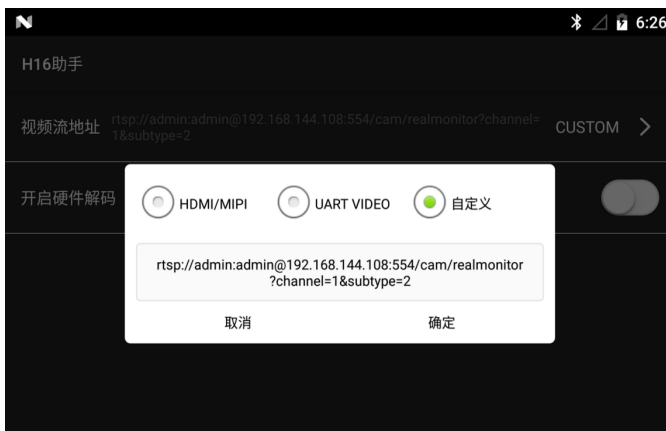

- ① The factory default setting is HDMI/MIPI mode, which is used to display the video/image transmitted through MIPI/HDMI from the receiver.
- ② UART VIDEO mode, to display single-axis gimbal and MINI camera videos/images (need to connect other conversion board).
- ③ Custom mode, this mode displays the video/image transmitted through the network port of the receiver.

## Part 6: How to show video & data transmission and telemetry

### Take QGC as the example for reference to connect video/image transmission

#### 1) Showing video/image from network port

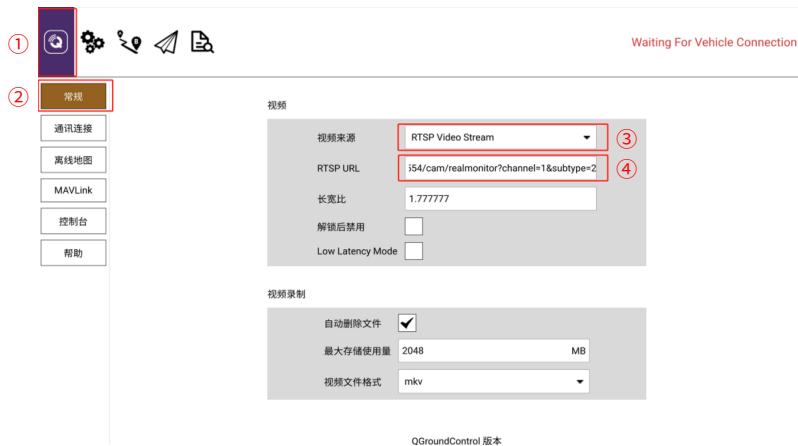

- ① Click the setting icon in QGC.
- ② Click “Normal”.
- ③ Change the video source to RTSP Video Stream.
- ④ Enter RTSP address of the video/image to RTSP URL.

#### 2) Showing MIPI, HDMI video/image

- ① Enter “rtsp://192.168.0.10:8554/H264Video” to RTSP URL is OK.

### Take QGC as the example for reference to connect data/telemetry transmission



- ① Click the communication link.
- ② Click “Add”.



- ③ Change the mode into UDP.
- ④ listening port to 14551.
- ⑤ Click “OK” to save.

## Part 7: How to connect the internet

The remote control can be connected to the Internet in three ways :

- ① Connected to 5G wifi network.
- ② Connected to the RJ45 port of the remote control.
- ③ Connected to the wireless internet card through the OTG port of the remote control for Internet access (currently only supports Huawei and CITIC wireless internet card).

## Part 8: How to share internet, video/image transmission and data/telemetry transmission

### ① Sharing network

When the remote control is connected to the Internet via the USB wireless internet card, the hotspot of the remote control can be turned on for network sharing.

### ② Sharing data transmission

- 1) Turn on the hotspot of the remote controller.
- 2) Connect the hotspot by PC.
- 3) (3) Open Mission Planner, choose the connecting way into TCP.

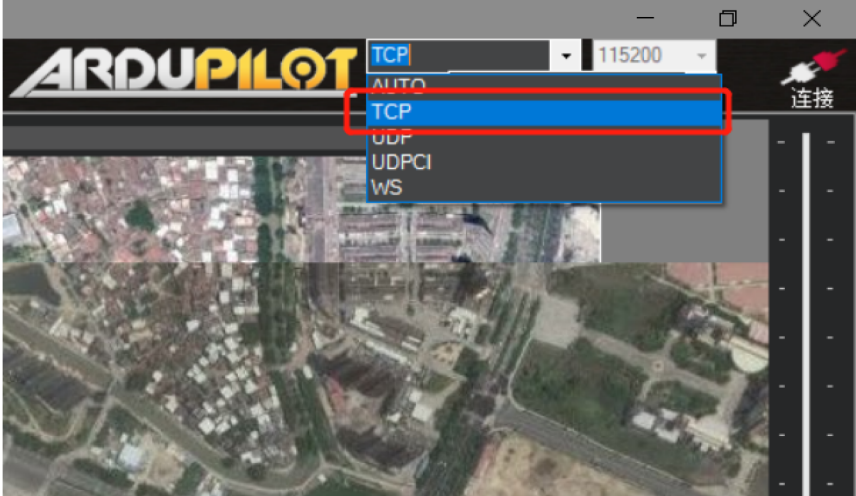

4) Click “connect”, enter 192.168.43.1 into the IP address and click “OK”.

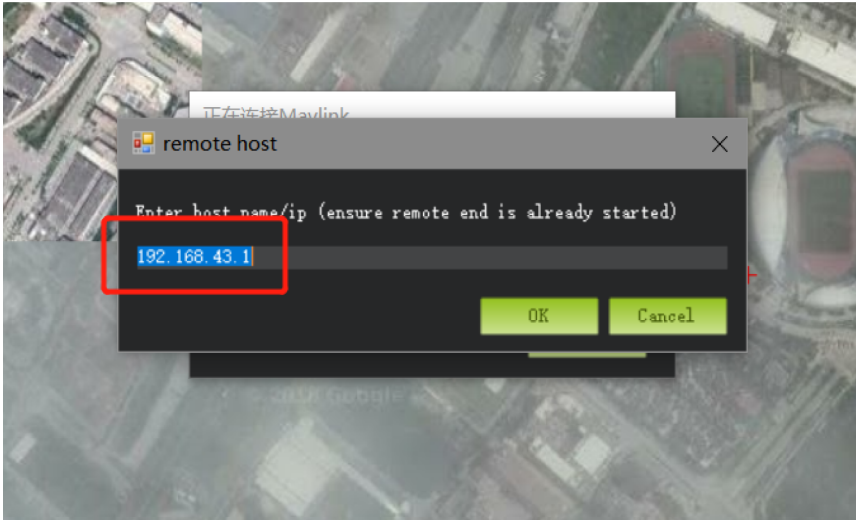

5)Port number, please enter “5760” and click “OK”, then, can get the telemetry.

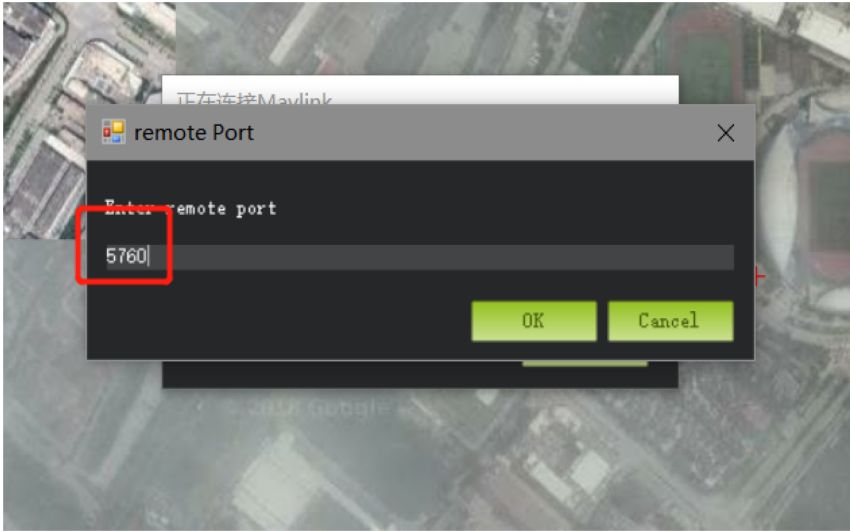

③ Sharing video/image transmission

- 1) Open the hotspot of the remote controller.
- 2) Connect the hotspot by PC.
- 3) Open “setting” in the PC, click on the “adapter”, select Ethernet, select the IPV4 protocol, select a custom IP address, enter according to the method in the figure, and click “OK”.

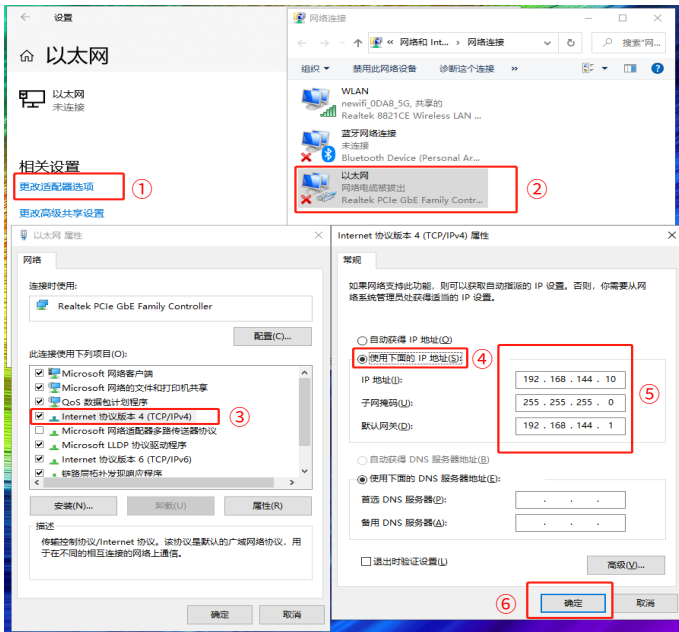

4) Download VLC exe. to show video/image.



5) Open VLC and choose network streaming.

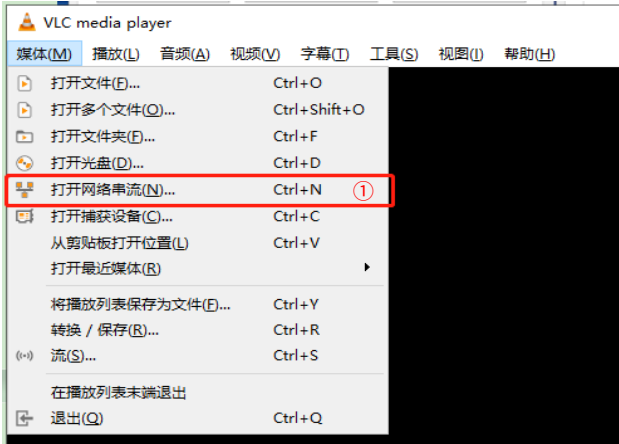

6) Enter "rtsp://192.168.43.1:8554/fpv\_stream" to URL and click "play".



## Part 9: master & slave controlling mode, coach mode and student mode

Master & slave controlling mode: Connect PPM port of each H16 with Aux cable (3.5mm audio cable) can implement a single operating of master controlling mode, a single operating of slave controlling mode and mixed controlling mode.

### Detail steps

- 1) Connect the PPM interface of the two H16 with an AUX cable, and then select one of them to bind with the drone and set it as the master controller. Log into the APP named as “H16 Assistant” and select the advanced parameters, enter the password “999”, click the coach mode, and choose the master controller mode. After selecting the channel of the coach switch, click Save (the coach switch only supports SW1-SW4).
- 2) Open another remote control to enter the “H16 Assistant” to select advanced parameters, enter the password 999 Click the coach mode, and choose the slave mode. Click to save.
- 3) Switch three modes with the coach controller’s SW switch.
  - ① The upper lever is the student mode, which means the student controls the drone completely, the coach does not participate. The coach can switch the mode to quickly take over when the students encounter a burst.
  - ② The middle lever is the mixed controlling mode. At this time, both remote controls can operate, and the coach can correct the operation of the student.
  - ③ The down lever is the coach mode, and the students cannot operate.

**Note:** When using the coaching mode, the student’s side only has 4 channels of two joysticks that can be used, while other channels are invalid. The student’s controller also cannot use the video & picture transmission and ground station App.

## Part 10: Q & A

1: Can the remote control install other apps?

The permissions of the remote control are all open, and there is no special software or restricted software installation and uninstallation.

2: How does the remote control enter the fast charge mode?

Only under using the original charger to enter the fast charge mode, and there is a text prompt on the lock screen interface.

3: How to get the RTSP address when using MIPI or HDMI camera?

Open the H16 helper, open the video to view, click on the settings (virtual button), click on the video stream address, click on custom to copy the link below that starts with RTSP. Then paste.

4: Data transmission/telemetry cannot be connected.

Check whether the ground station is connected with UDP way to connect to the TX and whether the listening port of the RX’s port 0 is 14551. Check whether the baud rate is normal. Check if RX and TX is connected reversely (connect RX to TX TX to RX correctly).

5: The video/image cannot be displayed after connecting to the webcam.

The video/image transmitted through the network port has a dedicated RTSP address. Not compatible with MIPI/HDMI. This RTSP address needs to be consulted with the webcam manufacturer.

6: The remote control's network port cannot be connected to the Internet.

Please turn off WIFI when connecting 5G network card or network port.

7: The remote control cannot connect to WIFI.

The remote control can only connect to the 5G band WIFI, and the mobile phone can change the hotspot to the 5G band hotspot.

8: Unable to share data/telemetry or video transmission.

Please check if there is a hotspot connected to the remote control.

## C.Maintenance, servicing

Storage for not using certain period

Put H16/H16 Pro in a dry and ventilated area. No direct sun light to prevent harm to the internal li-ion battery. If store it over three months, it is highly recommended to put room temperature between 22°C to 28 °C. DO NOT put it below 20 °C or higher than 45°C.

## D.Transportation and storage

### Warning

In order to prevent lost or getting hurt, please strictly follow the rules of operation:

Keep small parts or wire away from children can reach. DO NOT let children touch the small parts of H16/H16 Pro.

### Attention

- 1) DO NOT put H16/H16 Pro into water. If it does, please switch off the power and dry it at once!
- 2) DO NOT crash the H16/H16 Pro or break the battery is prohibited.

## E.Others



Facebook



YouTube

## FCC Statement

This equipment has been tested and found to comply with the limits for a Class B digital device, pursuant to Part 15 the FCC Rules. These limits are designed to provide reasonable protection against harmful interference in a residential installation. This equipment generates uses an can radiate radio frequency energy and, if not installed and used in accordance with the instructions, may cause harmful interference to radio communications. However, there is no guarantee that interference will not occur in a particular installation. If this equipment does cause harmful interference to radio or television reception, which can be determined by turning the equipment off and on, the user is encouraged to try to correct the interference by one or more of the following measures:

- Reorient or relocate the receiving antenna.
- Increase the separation between the equipment and receiver.
- Connect the equipment into an outlet on a circuit different from that to which the receiver is connected.
- consult the dealer or an experienced radio/TV technician for help.

This device complies with part 15 of the FCC Rules. Operation is subject to the following two conditions:

- (1) This device may not cause harmful interference.
  - (2) This device must accept any interference received, including interference that may cause undesired operation.
- Changes or modifications not expressly approved by the party responsible for compliance could void the user's authority to operate the equipment.



***SKYDROID* 云卓**

Quanzhou Skydroid Technology Co., Ltd.



Facebook



YouTube

[www.skydroid.xin](http://www.skydroid.xin)

# SKYDROID 云卓

泉州云卓科技有限公司



## 云卓-H16/H16 PRO

使用说明书 V1.0

# 目录

<b>一、概述</b>	3
产品特性	3
主要用途及适用范围	3
品种、规格	3
型号的组成及其代表的意义	4
端口定义图	6
使用环境条件	6
工作条件	6
安全	6
<b>二、使用、操作</b>	7
使用前的准备和检查	7
使用方法	7
语言设置	7
状态栏提示	8
H16助手介绍	8
对频操作	9
图像连接及设置	9
如何在地面站显示数传图传	10
如何联网	11
如何共享网络、数传、图传	12
主副控、教练、学员模式	15
常见问题与解决办法	15
<b>三、保养、维修</b>	16
<b>四、运输、储存</b>	16
<b>五、其他</b>	16

## 注意

本产品使用以下词条因操作不当可能带来的潜在危险加以分级说明。

**注意:** 如果不遵循说明进行操作,可能会导致财产损失和轻微伤害。

**注意:** 如果不遵循说明进行操作,可能会导致财产损失、重大事故和严重伤害。

**警告:** 通过阅读整个用户手册,熟悉产品的功能之后再进行操作。如果没有正确操作本产品可能会对自身或他人造成严重伤害,或者导致产品损坏和财产损失。本产品较为复杂,需要经过一段时间熟悉后才能安全使用,并且需要具备一些基本常识后才能进行操作,如果没有强烈的安全意识,不恰当的操作可能会导致产品损坏和财产损失,甚至对自身或他人造成严重伤害。本产品不适合儿童使用。切勿使用非云卓提供或建议的部件,必须严格遵守云卓的指引来使用产品。

## 一、概述

### 1、产品特性

① H16系列采用全新的澎湃处理器,搭载安卓嵌入式系统,采用先进的SDR技术,和超级协议栈,让图像更加清晰,延迟更低,距离更远,抗干扰更强,无论是无人机,机器人,工控设备等都可以应用。

② 支持HDMI、网口、sensor接口、双路串口透传、SBUS等丰富的接口,航拍、FPV安防、消防、电力、测绘机器人、边防等都可以得心应手,如至现场的体验。

③ 采用IP67级防水防尘防摔材料和结构,保证不仅仅是手感好,而且耐用。

④ H16采用7寸高清高亮显示屏,1800 nits亮度IPS液晶屏,阳光下依然可以清晰查看。支持1080P高清数字图传。双天线信号互相补充,超强信号,超远距离,配合算法控制和失步跳频算法,大大增加了弱信号通讯能力。H16图传距离5-10km, H16PRO图传距离20-30KM。

⑤ 采用高能量密度的锂离子电池,支持18w快充,满电可工作8-15个小时,一贯的荒野求生思维让您对设备的可靠性更加放心。

⑥ H16/H16 Pro 支持HDMI、网口、sensor接口、双路串口透传、sbus等丰富的接口。并支持更多的相机、云台、吊舱等视频设备。提供开发包, SDK和技术支持,支持视频悬浮,支持主流飞控的地面站,支持QGC与无线RTSP视频流分享。

⑦ 采用气象硅胶、磨砂橡胶、不锈钢、航空铝合金,使其拥有极致手感的同时,也满足了无人机户外使用的恶劣条件, H16在机身、控制开关、各外设接口处均做防尘、防水溅等保护措施,确保设备在恶劣环境中的稳定流畅运行。

⑧ 丰富的地面接口、教练PPM输入+输出、RJ45网络接口、远距离连接内网、Type-C安卓高速USB接口、OTG接口可接U盘、网卡、拓展TF卡插槽等。

⑨ 独立的2维度云台控制杆,让云台飞手得心应手、如鱼得水。

### 2、主要用途及适用范围

用于遥控操作直升机、固定翼、多旋翼、车、船等进行视频图像传输(需选配摄像头)、数据传输、和操控无人机飞行。

### 3、品种、规格

产品参数

遥控器参数			
型号	H16/H16 PRO	通道数	16
工作电压	4.2V	射频功率	20DB@CE/23DB@FCC
频段	2.400-2.483GHz	跳频	全新FHSS跳频
升级	APP在线升级	重量	1034克
尺寸	272*183*94毫米	电池	20000mA/H
续航时间	6-20小时	充电接口	TYPE-C
应用	直升机、固定翼、多旋翼、车、船		

接收机参数

型号	R16	通道数	16
工作电压	7.2-72V	射频功率	20DB@CE/23DB@FCC
尺寸	76*69*11毫米	重量	90克

三体-MIPI摄像头

型号	MIPI	工作电流(开灯)	140mA
工作电压	14-72V	工作电流(不开灯)	14mA
尺寸	102.1*42.6*36.5毫米	重量	55克

#### 4、型号的组成及其代表的意义

H16/H16 PRO遥控器

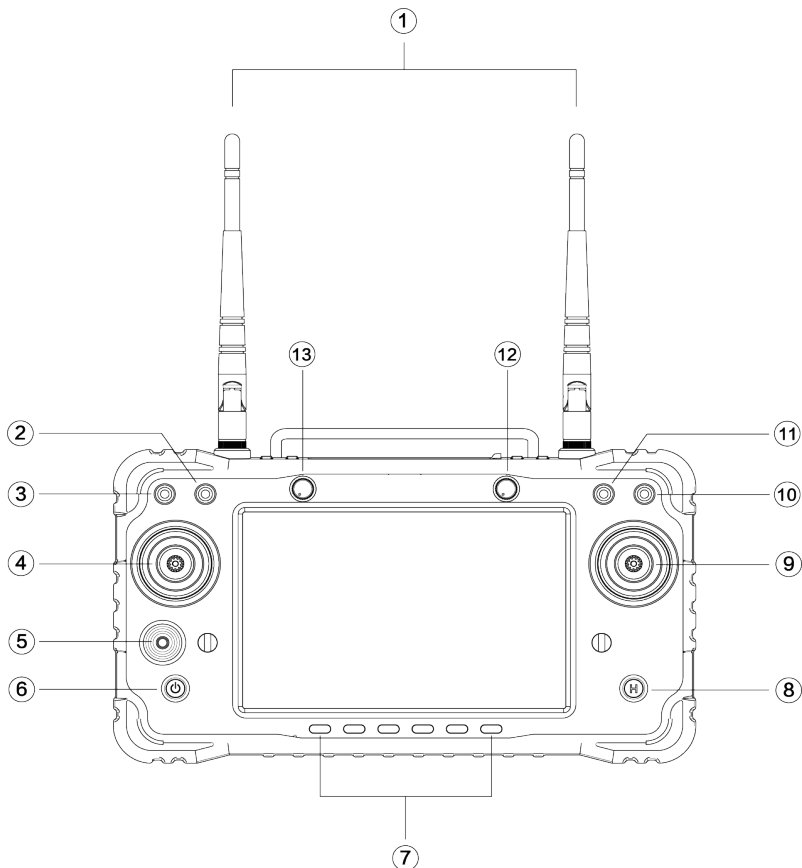

## 各按键代表的含义

序号	注解	序号	注解
1	2.4G 3dB 天线	10	拨动三档开关SW4
2	拨动三档开关SW2	11	拨动三档开关SW3
3	拨动三档开关SW1	12	旋钮 AUX2
4	左摇杆 X1、Y1	13	旋钮 AUX1
5	小摇杆 X3、Y3		
6	电源开关		
7	六段开关		
8	按键(默认MIPI LED灯开关)		
9	右摇杆 X2、Y2		

## 接收机

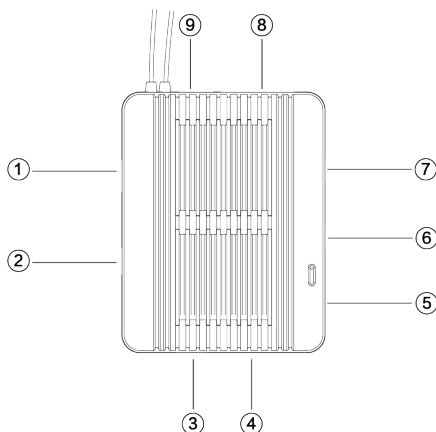
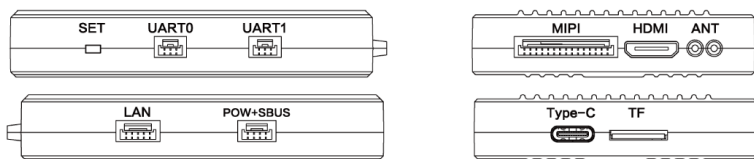

序号	注解	序号	注解
1	网口	6	串口0
2	电源和SBUS输入	7	串口1
3	Type-C接口	8	MIPI摄像头接口
4	TF卡接口	9	HDMI输入
5	对拼按钮		

## 5. 端口定义图

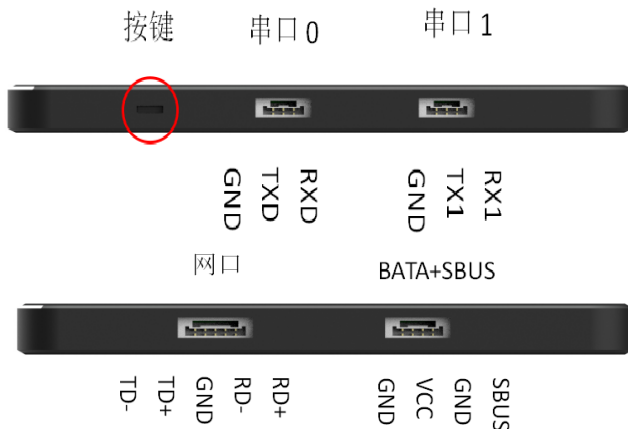

## 6. 使用环境条件

### 注意

- A) 环境温度:  $-10^{\circ}\text{C} \sim +55^{\circ}\text{C}$
- B) 贮存温度:  $-25^{\circ}\text{C} \sim +70^{\circ}\text{C}$ 。
- C) 相对湿度: Not exceed 85%。
- D) 大气压力:  $86\text{kPa} \sim 106\text{kPa}$
- E) 使用地点不允许有爆炸危险的介质, 周围介质中不应含有腐蚀金属和破坏绝缘的气体及导电介质, 不允许充满水蒸气及有严重的霉菌存在。
- F) 使用地点应具有防御雨、雪、风、沙、灰的设施。

## 7. 工作条件

### 供电方式和注意事项

H16系列地面端内置一体式可充电锂电池, 兼容市场标准TYPE-C接口, 9v-2A规格的电源适配器(例如手机、相机等数码产品USB充电器)进行充电。

如在地面端充电时遇到冒烟、有异味、漏液的情况下时, 请勿继续给地面端充电, 请移送至本公司进行维修。

请勿在婴儿触碰区域给本产品进行充电, 以免发生触电危险。请勿在超过 $60^{\circ}\text{C}$ 的环境下对本产品进行充电。

## 8. 安全

### 警告

初学者请特别注意以下安全事项! 请细读!

- ⊗ 禁止在疲劳、醉酒等身体状态不佳时飞行!
- ⊗ 禁止在下雨、强风等恶劣天气时飞行!
- ⊗ 禁止在接近高压线、通信基站、有人聚集或者活动的场所飞行!
- ⊗ 禁止在机场和其他明令禁飞的地方飞行!
- ⊗ 禁止在人群集中的地方、停车区域或者其他可能造成财产损失或者人身伤害的区域操控飞行模型
- ⚠ 飞行前, 做好飞行器的设备检测, 检查收发系统与飞行器是否正常;
- ⚠ 请使用有保障的专业充电器为电池充电。
- ⚠ 本产品天线为脆弱部件, 避免受力过度破坏。

## 二、使用、操作

### 1、使用前的准备和检查

#### 注意

- ① 使用前务必先检查遥控器电量是否充足。
- ② 使用前请检查天线是否按要求摆放, 已获得最佳效果。
- ③ 首次使用请确保固件已经升级至最新版本。
- ④ 用户应确保自己不在醉酒、药物影响下操作使用。

### 2、使用方法

#### 第一部分 语言设置

- ① 进入系统设置, 选择语言和输入法



- ② 进入语言和输入法后, 点击语言可进行语言的切换、添加、删除

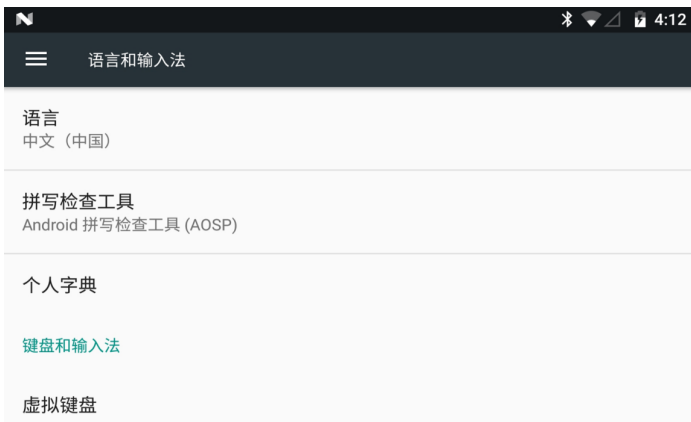



## 第二部分 状态栏提示



- ① 通过网口、USB联网成功标识
- ② 遥控器与接收机信号强度标识 (图中为未连接接收机)
- ③ 电量显示
- ④ 时间显示
- ⑤ 返回按键
- ⑥ 返回主界面按键
- ⑦ 后台任务管理/分屏按键

## 第三部分 H16助手介绍



- ① 对遥控器的摇杆操作方式进行切换。
- ② 检查遥控器各个通道的值是否正常。
- ③ 可以查看MIPI、HDMI、UART VIDEO和其他RTSP视频 (详细在下方介绍)
- ④ 将遥控器与其他接收机进行对频 (对频方法在下方介绍)
- ⑤ 高级参数里可调整通道、升级摇杆固件、修改接收机串口波特率 (密码999仅限专业人员调试)

#### 第四部分 对频操作

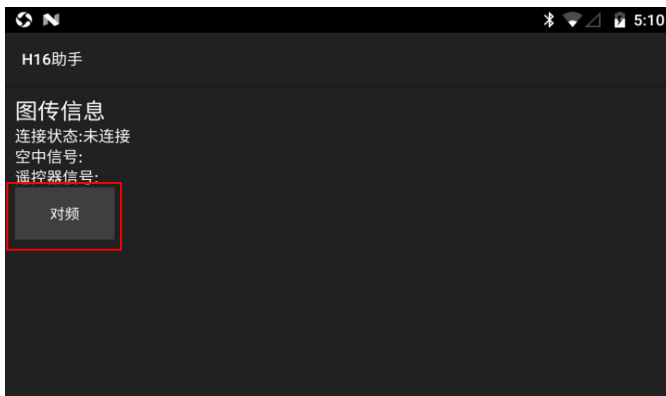
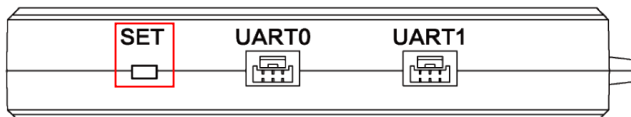

- ① 将接收机通电后等待3-5秒后长按接收机SET, 白灯闪烁时松开SET
- ② 进入H16助手, 点击对频, 点击对频(对频成功后会显示已连接)

#### 第五部分 图像连接及设置

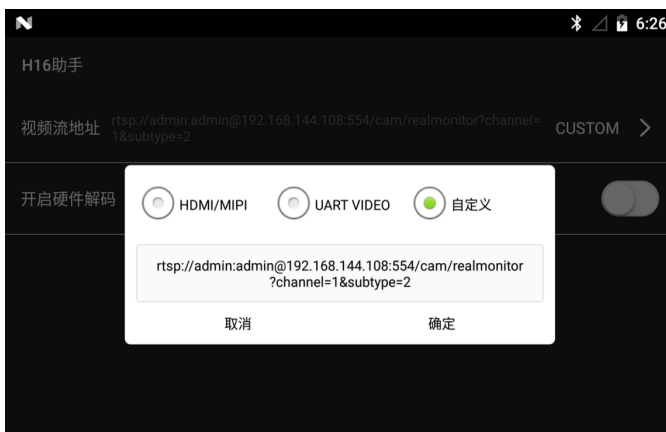

- ① 出厂默认设置为HDMI/MIPI模式, 用来显示通过接收机端MIPI/HDMI传输的图像
- ② UART VIDEO模式, 来显示单轴云台、MINI摄像头图像(需要另接转换板)
- ③ 自定义模式, 此模式来显示通过天空端的网口来传输图像

## 第六部分 如何在地面站显示数传图传

以QGC地面站为例做参考连接图传

### 1) 显示网口的图像

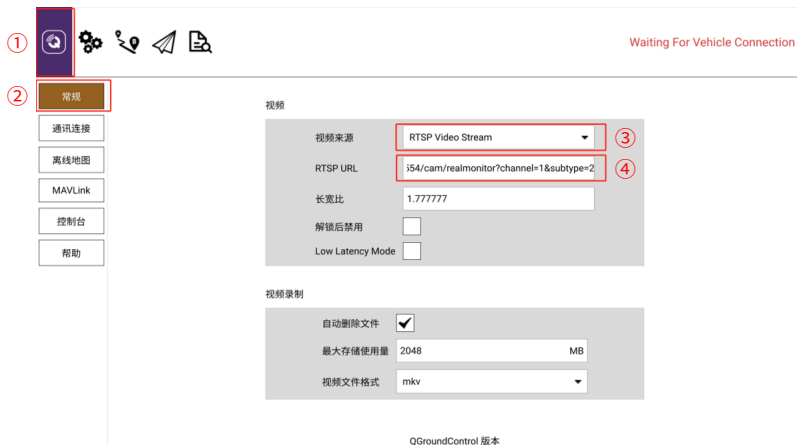

- ① 点击QGC中的系统设置标识
- ② 点击常规
- ③ 将视频来源更改为RTSP Video Stream
- ④ 在RTSP URL填入图像的RTSP地址

### 2) 显示MIPI、HDMI的图像

- ① 在RTSP URL中填入rtsp://192.168.0.10:8554/H264Video即可

以QGC地面站为例做参考连接数传



- ① 点击通讯连接
- ② 点击添加



- ③ 将类型更改为UDP
- ④ 监听端口改为14551
- ⑤ 点击确定进行保存

## 第七部分 如何联网

遥控器可以通过三种方式联网

- ① 连接5Gwifi联网
- ② 通往遥控器端的WAN口联网
- ③ 通过遥控器端的OTG口连接无线卡托进行上网(目前只支持华为 中信品牌)

## 第八部分 如何共享网络、图传、数传

### ① 共享网络

当遥控器通过USB无线卡托上网时可以将遥控器的热点打开,进行网络共享

### ② 共享数传

1)遥控器打开热点

2)用电脑连接遥控器的热点

3)打开Mission Planner, 连接方式选择TCP

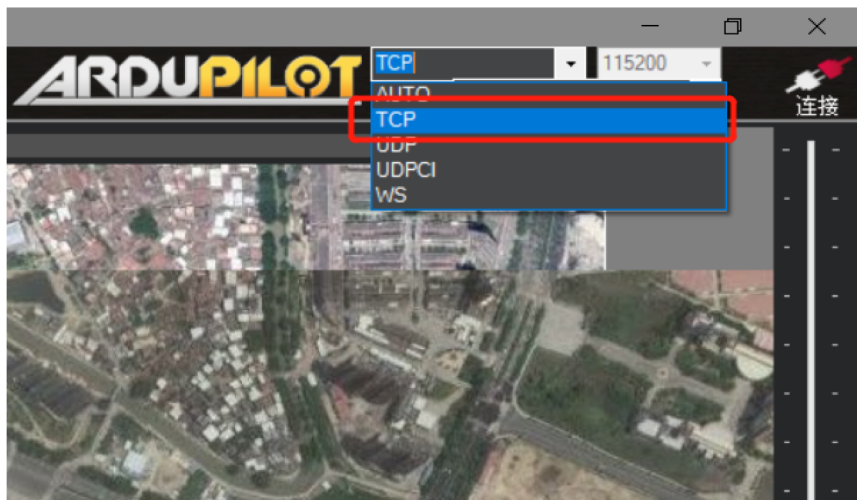

4)点击连接后,IP输入192.168.43.1输入完成后点击OK

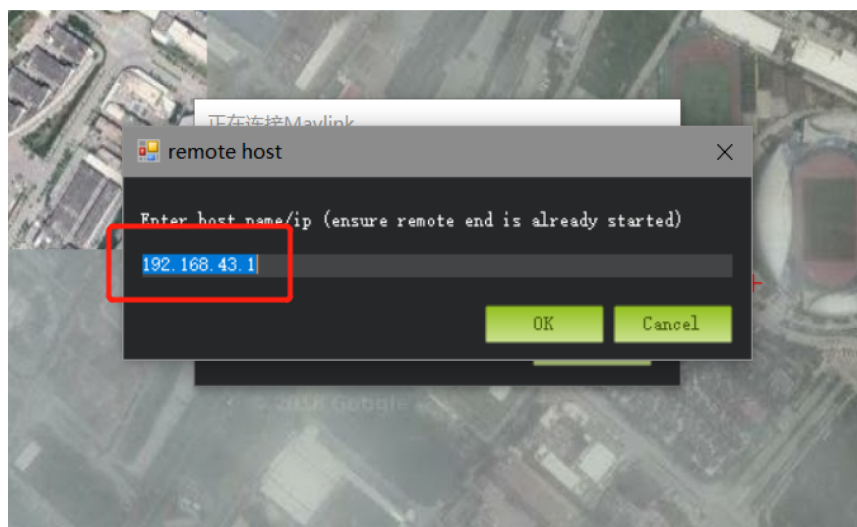

5)端口号输入 5760 点击ok,即可连上数传。

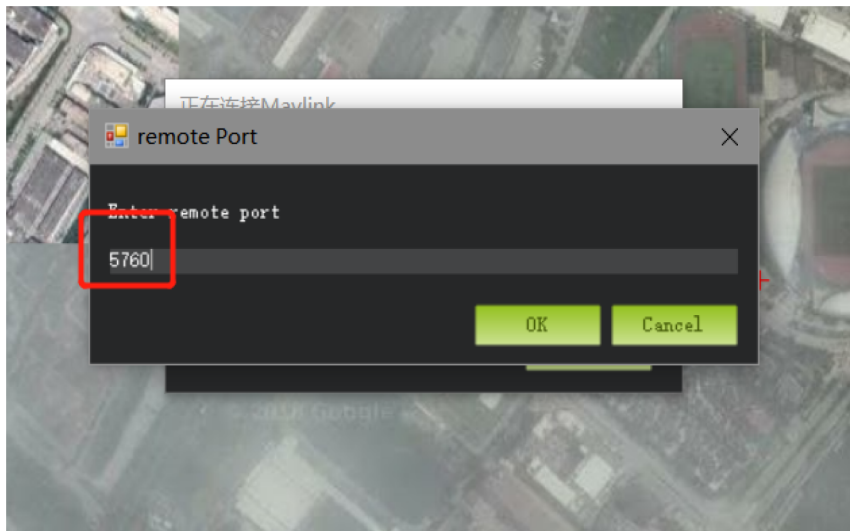

### ③共享图传

- 1) 遥控器打开热点
- 2) 用电脑连接遥控器的热点
- 3) 打开电脑的设置, 点击适配器、选择以太网、选择IPV4协议、选择自定义IP地址、按图中的方式输入、点击确认

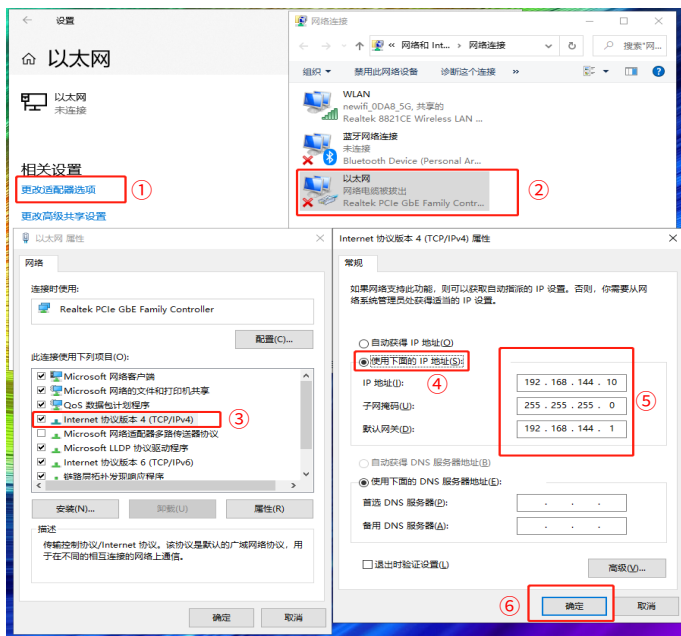

4) 下载VLC软件来进行显示图像

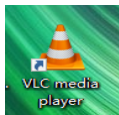

5) 打开VLC软件, 在媒体中选择网络串流



6) 在网络URL的输入栏中, 输入rtsp://192.168.43.1:8554/fpv\_stream后点击播放



## 第九部分 主副控、教练、学员模式

主副控:通过Aux连接线(3.5MM音频线)连接两台H16 遥控器的ppm口可以实现主控单独操作模式,副控单独操作模式,以及主副混控模式。

具体操作步骤:

1) 使用Aux连接线插入两台遥控器顶端的ppm接口,然后选取其中一台与飞机对频。对频后设置为教练控。进入遥控器内打开H16助手选择高级参数,输入密码999后点击教练模式,选择为教练控主机模式。选择教练开关的通道后点击保存(教练开关仅支持SW1-SW4)。

2) 打开另一台遥控器进入H16助手选择高级参数,输入密码999点击教练模式,选择为学员控从机模式,点击保存。

3) 在教练控端SW开关控制三个模式切换。

① 开关向上拨是学员模式,由学员完整操作,教练不参与。当学员遇到突发情况时教练可以切换模式快速接管。

② 开关拨到中间为混控模式,此时两台遥控器都能操作,教练可以对学员的操作进行修正。

③ 开关向下拨为教练模式,此时学员控无法操作。

**备注:**使用教练模式时学员控端只有两个摇杆的4个通道可以操作,其他通道操作无效。学员控也无法使用图传及地面站App。

## 第十部分 常见问题与解决办法

1: 遥控器可以安装其他APP吗?

答:遥控器端权限全开放,没有任何专用软件和限制软件的安装与卸载。

2: 遥控器如何进入快充模式?

答:必须使用专配的充电器才会进入快充模式,在锁屏界面有文字提示。

3: 使用MIPI或HDMI摄像头如何获取RTSP地址

答:打开H16助手,打开视频查看点击设置(虚拟按键),点击视频流地址,点击自定义将下方以RTSP开头的链接复制,然后进行粘贴。

4: 数传无法连接

答:检查遥控端地面站是否是已UDP的类型去连接遥控器,接收机串口0 (UART0) 监听端口是否为14551。检查波特率是否正常。检查RX、TX是否反接(正确接法RX接TX、TX接RX)。

5: 连接网络摄像头后无法显示图像

答:通过网口传输的图像,有专用的RTSP地址。与MIPI/HDMI的不通用。此RTSP地址需和网络摄像厂家询问。

6: 遥控器的网口连接后无法上网

答:在连接5G网卡和网口时请将WIFI关闭。

7: 遥控器无法连接WIFI

答:遥控器只能连接5G频段的WIFI,手机可将热点更改为5G频段的热点。

8: 无法共享数传或图传

答:请检查是否有连接到遥控器的热点。



### 三、保养、维修

长期停放时的维护、保养

将遥控器存放于干燥通风处，减少阳光直射以防止电池过热。若需存放超过三个月，则推荐的存放温度区间为22摄氏度至28摄氏度。切勿将电池存在于低于零下20摄氏度或高于45摄氏度的场所。

### 四、运输、储存

#### 警告

为避免可能的伤害和损失，务必遵守以下各项：

由于线材和小零件可能对儿童造成危险，所以务必让儿童远离遥控器的部件。

#### 注意

- 1) 切勿让遥控器浸入水中，若入水，请及时用松软干布擦拭，并立即关闭电源。
- 2) 禁止机械撞击、碾压、刺穿电池，禁止将电池跌落。

### 五、其他



QQ群



微信公众号



新浪微博



优酷平台

说明书如有更新，恕不另行通知，请持续关注官网[www.skydroid.xin](http://www.skydroid.xin)

**SKYDROID 云卓**

泉州云卓科技有限公司

泉州云卓科技有限公司

[www.skydroid.xin](http://www.skydroid.xin)