

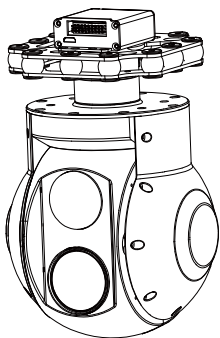

**U30TIR 30x Optical Zoom  
EO + IR Dual-Sensor Object  
Tracking Gimbal Camera**

User Manual

使用说明



Standard Version

标准版

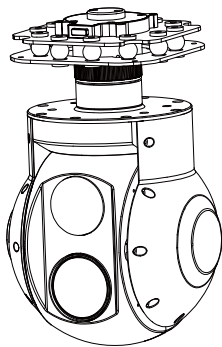

Viewport Version

快拆版



For more details please scan the QR code  
or visit our website:

[www.viewprotech.com](http://www.viewprotech.com)

## Disclaimer and Warning

Congratulations on purchasing your new Viewpro product. Please read this entire document carefully. Failure to read or follow instructions and warnings in this document may result in damage to your Viewpro product. Disassemble the gimbal camera by user is not permitted, as which may cause the camera does not work normally. Viewpro accepts no liability for damage, injury or any legal responsibility incurred directly or indirectly from the use of this project. The user shall observe safe and lawful practices including, but no limited to, those set forth in the manual.

### Legends



Warning



Important Note









## 1.Product Introduction

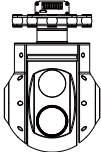
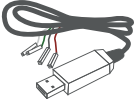

### 1.1 Introduction

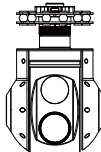
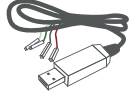
U30TIR is a high-precision 2-axis gimbal integrated with a 30x optical zoom SONY camera and a 25mm lens 640\*480 IR thermal sensor. It supports visible optical zoom, IR thermal and visible PIP switch, IR color palette switch, photographing and video, target tracking, thermal digital zoom. When the external GPS and time input, the OSD can display angle, zoom times, GPS and real-time and tracking frame, also can select to turn off the OSD. It features fast focus, aluminum alloy housing and anti-interference. The 3 axis gimbal can achieve stabilization in yaw, roll and pitch. The integrated design of damping system and gimbal can greatly reduce mechanical vibration.

U30TIR is widely used in UAV industries of public security, electric power, fire fighting, zoom aerial photography and other industrial applications.

## 1.2 In the Box

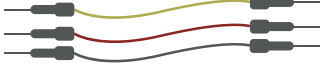
<b>A. Standard Version</b>			
Gimbal Camera x 1 pc		USB to TTL Cable x 1 pc	
Copper Cylinder x 4 pcs		M3 Screw x 8 pcs	
Power Cable x 1 pc			
<b>B. Viewport Version</b>			
Gimbal Camera x 1 pc		USB to TTL Cable x 1 pc	
Copper Cylinder x 4 pcs		M3 Screw x 8 pcs	
Power Cable x 1 pc			
PWM Control Cable x 1 pc			

TTL / S.BUS Control Cable x 1 pc	
TTL Connect Cable x 3 pcs	
Ethernet Cable x 1 pc	

## 2. Installation Instruction

### 2.1 Overview

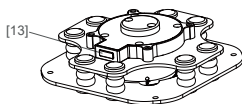
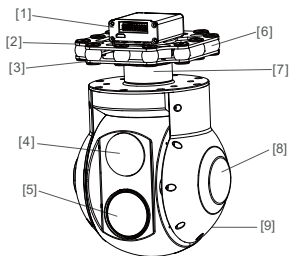

Viewport

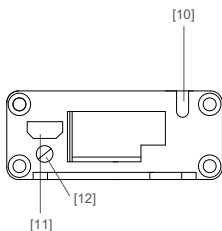

Control Box Back Side  
(Standard Version)

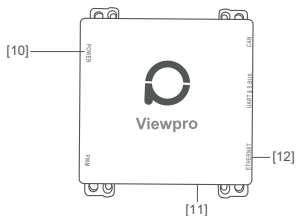

(Viewport Version)

- [1] Control box
- [2] Upper damping board
- [3] Lower damping board
- [4] FHD zoom camera
- [5] Infrared thermal camera
- [6] Damping ball
- [7] Yaw axis motor
- [8] Pitch axis motor
- [9] TF card slot
- [10] 3-6S power interface
- [11] Micro HDMI interface
- [12] Ethernet interface
- [13] Viewport unlock button



- Please ensure that there isn't any obstacle while the motor rotating.
- Please remove the obstacle immediately if gimbal camera is blocked during rotation.



- Don't put the infrared thermal camera towards the sun in case any burn to the camera

## 2.2.1 Control Box Printing (Standard Version)

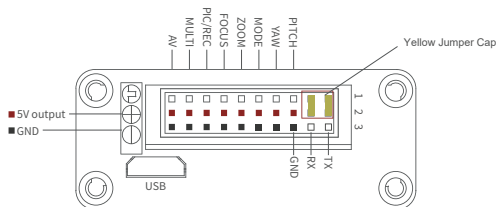

- The input voltage cannot be higher than 6S.
- The pin insertion interface cannot be connected with power supply.
- The yellow jumper cap cannot be removed

## 2.2.2 Control Box Printing (Viewport Version)



Front Side

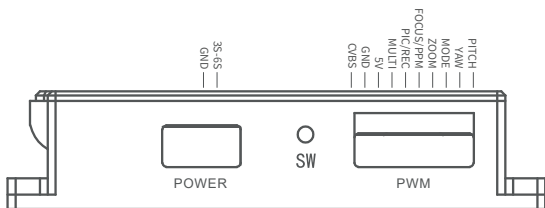

Left Side

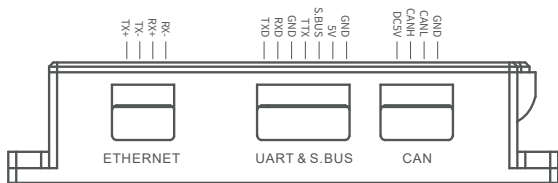

Right Side

## 2.3 Device Dimensions (Standard Version)

Unit: mm

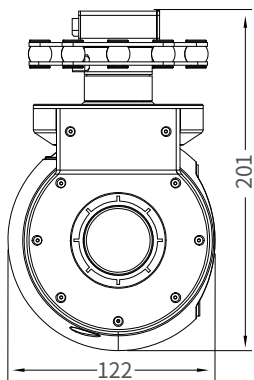
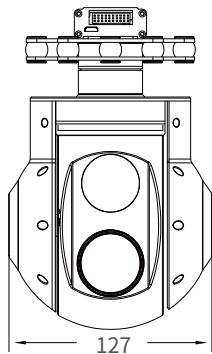
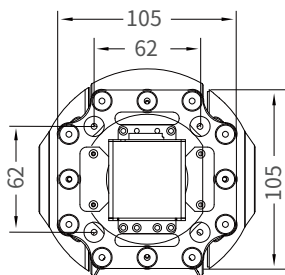

## 2.3 Device Dimensions (Viewport Version)

Unit: mm

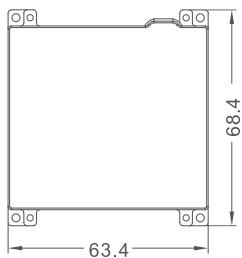
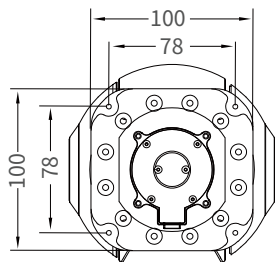

Control Box

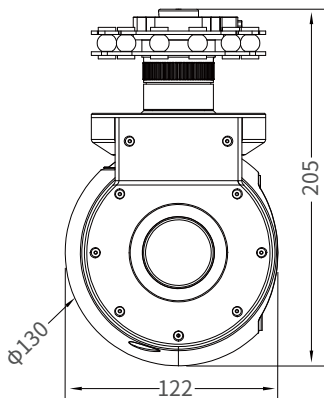
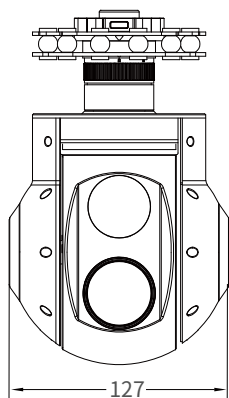



## 2.4 Install Mounting Part

- (1) Find out the arrow on the gimbal which indicating the yaw heading of the payload (i.e. the lens direction when the camera power on), and synchronize with the direction specified by the UAV.
- (2) Fix one end of the copper cylinder on the screw hole of lower damping board, and use M3 screw to fasten it.
- (3) According to the provided screw hole dimension you can make suitable mounting holes on the UAV mounting board, and fixes the other end of the copper cylinder on the mounting board of the UAV (Viewport version is the same).

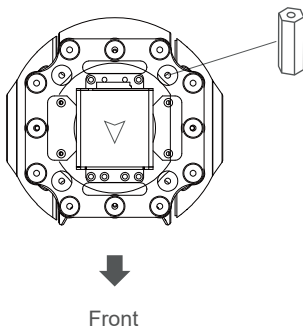

## 2.5 Viewport Release Instruction

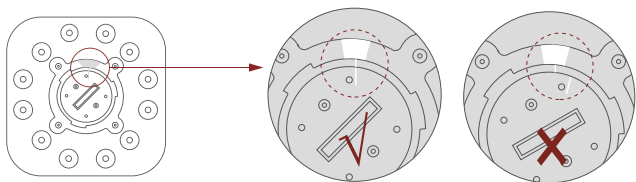
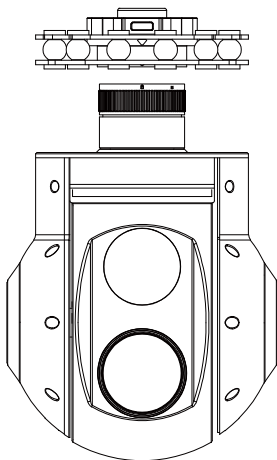

1. Make sure the two white stripes indicated in above picture are aligned with each other. (If the stripes are not aligned to each other, please pinch the connector part and turn it to left manually)

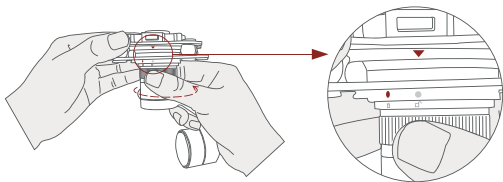

2. Align the white dot (unlock icon) to the red triangle (below unlock button), push the gimbal into the Viewport completely and then rotate the gimbal camera anticlockwise.

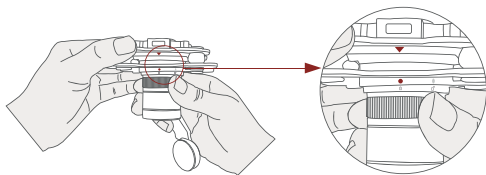

3. When you hear "click" sound (when red dot is aligned to the red triangle) means the gimbal camera and Viewport has been locked.

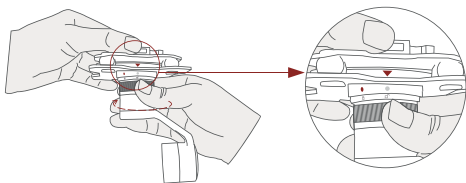

4. To unlock the Viewport, you need to press on unlock button and rotate the gimbal camera clockwise till the white dot align to the red triangle. Then pull the gimbal out from the Viewport.

## 2.6 Install TF Card

TF (Micro SD card): Install the TF card to the card slot (Re. 2.1 Overview). Support max 128GB. Request Class 10 (10m/s) transmission speed or higher and FAT32 or exFAT format.



- Make sure device is power off when inserting the TF card, hot plugging is not supported.
- 

## 2.7 Image Output Interface

HDMI: micro HDMI output, HD 1080P 60/50/30/25fps, 1080P 60fps as default. (Optional)

Network: Ethernet output interface, support RTSP/RTMP/UDP video streaming. Default: RTSP output, IP address: RTSP://192.168.2.119:554, output resolution: 720P (record in 1080p), frame rate: 25fps, bit rate: 2M. (Optional)

SDI: SMA outer screw inner hole interface, 1080P 30fps output. (Optional)

AV: no AV output



- 
- Above output mode is optional, HDMI and SDI output cannot coexist at the same time. Please subject to your actual product.
  - When using user interface software Viewlink for network connection, the network of external device (computer) should be the IP address: 192.168.2.2 (choose the last byte among 2~254, can not be 119 same as the gimbal), subnet mask: 255.255.255.0, Default gateway: 192.168.2.1, and all firewalls of the computer must be closed. Then enter the IP address of the gimbal camera, Open Video, the video stream can be outputted.
- 

## 3. Signal Control

### 3.1 PWM Control

Control the gimbal camera functions by the multiplex pulse width modulation signal outputted by PWM channel of the remote control receiver. The camera needs up to 6 control channels of PWM (to expand tracking function use up to 7 PWM channels). You can choose needed functions according to actual usage to reduce the required number of PWM channels.

#### 3.1.1 PWM Connection Diagram (Connect pitch channel as example)

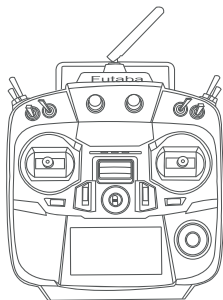

Remote Controller

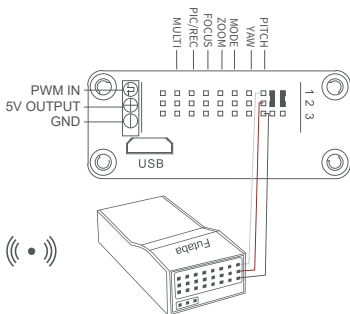

Receiver

### Connection Diagram (Standard Version)



Remote Controller

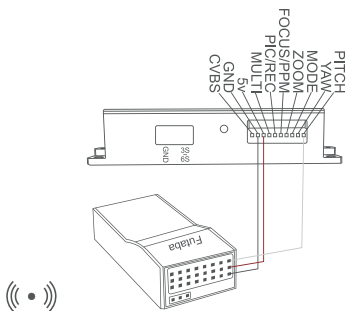

Receiver

### Connection Diagram (Viewport Version)

### 3.1.2 PWM Control Operation Instruction

**1) Pitch** (PWM Pitch channel in to control Pitch. Joystick, rotary knob or 3-gear switch on remote control are optional. 3-gear switch as example.)



Position 1

Low Gear  
Pitch Up



Position 2

Middle Gear  
Pitch Stop



Position 3

High Gear  
Pitch Down

**2) Yaw** (PWM Yaw channel in to control Yaw. Joystick, rotary knob or 3-gear switch on remote control are optional. 3-gear switch as example.)



Position 1

Low Gear  
Yaw Left



Position 2

Middle Gear  
Yaw Stop



Position 3

High Gear  
Yaw Right

**3) Mode** (PWM Mode channel in to adjust speed control/one key to Home position etc functions. Rotary knob or 3-gear switch on remote control are optional. 3-gear switch as example.)



Position 1

Low Gear



Position 2

Middle Gear



Position 3

High Gear

Position 1: Low speed mode, control pitch / yaw with this mode at lowest speed

Position 2: Middle speed mode, control pitch / yaw with this mode at middle speed

Position 3: High speed mode, control pitch / yaw with this mode at highest speed

(If it is controlled by rotary knob, the speed will change according to switch position)

### Function of continuous switching:

**3.1)** Operate 1 time continuously and quickly, from position 2 - 3 - 2, to Home position.

**3.2)** Operate 2 times continuously and quickly, from position 2 - 3 - 2 - 3 - 2, the camera lens looks vertically down.

**3.3)** Operate 3 times continuously and quickly, from position 2 - 3 - 2 - 3 - 2 - 3 - 2, to disable Follow Yaw Mode (gimbal yaw not follows by frame)

**3.4)** Operate 4 times continuously and quickly, from position 2 - 3 - 2 - 3 - 2 - 3 - 2 - 3 - 2, to enable Follow Yaw Mode (gimbal yaw follows by frame)



**4) Zoom** (PWM Zoom channel in to control Zoom. Joystick, rotary knob or 3-gear switch on remote control are optional. 3-gear switch as example.)



Position 1

Low Gear  
Zoom Out



Position 2

Middle Gear  
Stop Zoom



Position 3

High Gear  
Zoom In

**5) Focus** (PWM Focus channel is to control PIP / IR color palette switch. 3-gear switch as example.)



Position 1

Low Gear  
PIP switch



Position 2

Middle Gear  
No control



Position 3

High Gear  
IR color palette switch

Switch from Position 2 to 1: Picture in Picture. EO+IR , IR+EO, EO only, IR only.

Switch from Position 2 to 3: IR color switching: white hot, black hot, pseudo color.

**6) Pic/Rec** (PWM Pic/Rec channel in to control take picture and record. Joystick, rotary knob or 3-gear switch on remote control are optional. 3-gear switch as example.)



Position 1

Low Gear



Position 2

Middle Gear



Position 3

High Gear

Switch from Position 2 to 1: Take a picture

- OSD display 'REC IMG' a second.

Switch from Position 2 to 3: Start record / repeat operation to stop record

- Start record, the OSD display rec hh:mm:ss.
- Stop record, the OSD display STBY.

## 7) Multi: IR digital zoom / tracking control



Position 1

Low Gear



Position 2

Middle Gear



Position 3

High Gear

Switch from Position 2 to 1: IR digital zoom, 1x~4x

Switch from Position 2 to 3:

- Exit the tracking, display the cross cursor. Adjust the cross cursor to lock target object and start tracking

Switch from Position 3 to 2:

- Cancel tracking



## Diagram of USB to TTL Cable:

Connect the camera to the upper computer by USB to TTL cable (Adopt connection method of TX to RX, RX to TX, GNG to GND at Dupont ends of the provided USB to TTL cable, connect to the specified TTL of the gimbal, and the USB end of the cable connect to computer).

Install Viewlink control software to test the functions directly. Users may choose to develop their own software, please contact technical support for TTL control protocol file.

ViewLink is a user interface developed by Viewpro for Viewpro gimbal cameras, you can download it from Viewpro website ([www.viewpro-tech.com](http://www.viewpro-tech.com)) or ask distributors for installation package.



- Connect serial port of gimbal to pins, DO NOT connect with power supply.
  - The default baud rate of serial port is 115200, which can be changed according to the docking equipment.
- 

### 3.3 S.BUS Control

Control the gimbal camera functions by one combining signals. Connect the external S.Bus to S.Bus port on the control box, and the external S.bus signal GND connect to the GND interface of the control box.

Wiring Diagram (Take Futaba remote control for example):

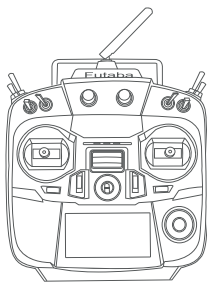

Remote Control

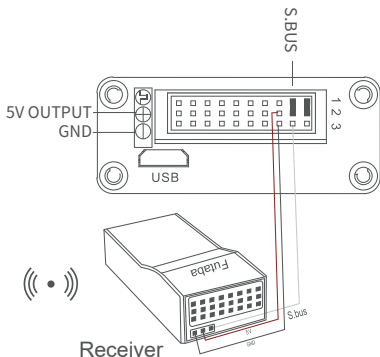

Wiring Diagram Standard Version

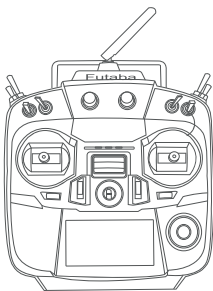

Remote Control

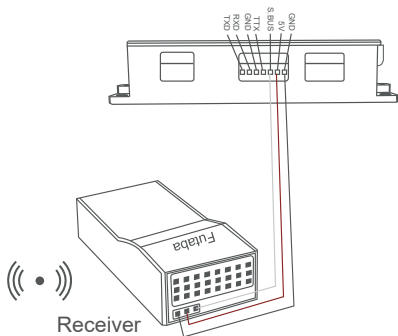

Wiring Diagram Viewport Version

S.Bus control mode: default S.Bus signal channel 9-15 to control gimbal camera functions (the function of channel is consistent with corresponding channel in PWM function description)

Channel 9: Yaw Control

Channel 10: Pitch Control

Channel 11: Mode Control

Channel 12: Zoom Control

Channel 13: Focus Control

Channel 14: Pic/Rec Control

Channel 15: Multi Backup



- User can set the channels by setting serial command according to the actual requirement. The S.Bus channel position can be arranged in any sequence within channel 1-15 to connect with the flight controller or remote control.

- TTL control and S.bus control cannot coexist at the same time for standard version. The default control is TTL if no requirement. The user can set to S.bus control if needed (please contact with our technical support for the setting instruction.)

---

### 3.4 TCP control

For Viewpro gimbal cameras with Ethernet output, the default IP address is: 192.168.2.119, control port: 2000. You can send the corresponding protocol to realize TCP control after connecting.

The TCP control protocol is [Frame header: EB + command ID: 90 + data body (serial port protocol) + Checksum (CS = body checksum, checksum is calculated as a sum of all bytes of data body modulo 256)]. Or directly use UI Viewlink to control after TCP connection.

## 4. Specification

Hardware Parameter	
Working voltage	12V
Input voltage	3S ~ 6S
Output voltage	5V (connect with PWM)
Dynamic current	770~1000mA @ 12V
Idle current	770mA @ 12V
Working environment temp	-20℃ ~ +60℃
Output	micro HDMI(1080P 25fps/30fps/50ps/60fps) / IP (720p/1080p 25fps/30fps) / SDI (1080P 30fps)
Local-storage	TF card (Up to 128G, class 10, FAT32 or ex FAT format)
Photo storage format	JPG(1920*1080)
Video storage format	MP4 (1080P/720P 25fps/30fps)
Control method	PWM / TTL / S.BUS / TCP(IP output)
Gimbal Spec	
Mechanical Range	Pitch/Tilt: -40° ~ 120°, Yaw/Pan: ±300° / ±360° *N (IP / SDI output version)
Controllable Range	Pitch/Tilt: -30° ~ 90°, Yaw/Pan: ±290° / ±360° *N (IP / SDI output version)

Vibration angle	Pitch/Roll: $\pm 0.02^\circ$ , Yaw: $\pm 0.02^\circ$
One-key to center	√
<b>Camera spec</b>	
Imager Sensor	SONY 1/2.8" "Exmor R" CMOS
Picture quality	Full HD 1080 (1920*1080)
Effective pixel	2.13MP
Lens optical zoom	30x, F=4.3~129mm
Digital zoom	12x (360x with optical zoom)
Min object distance	10mm(wide end) to 1200mm(tele end) Default 300mm
Horizontal viewing angle	1080p mode: 63.7°(wide end) ~ 2.3°(tele end)
Sync system	Internal
S/N ratio	more than 50dB
Min illumination	Color 0.01lux@F1.6
Exposure control	Auto, Manual, Priority mode(shutter priority & iris priority), Bright, EV compensation, Slow AE
Gain	Auto/Manual 0dB to 50.0dB(0 to 28 steps + 2 setep/ total 15 steps) Max.Gain Limit 10.7 dB to 50.0dB (6 to 28 steps + 2 step/ total 12 steps)
White balance	Auto, ATW, Indoor, Outdoor, One Push WB, Manual WB, Outdoor Auto, Sodium Vapor Lamp (Fix/Auto/Outdoor Auto)



Shutter speed	1/1s to 1/10,000s, 22 steps
Backlight compensation	Yes
Aperture control	16 steps
Defog	Yes
OSD	Yes

### Camera Object Tracking

Update rate of deviation pixel	50Hz
Output delay of deviation pixel	5ms
Minimum object contrast	5%
SNR	4
Minimum object size	32*32 pixel
Maximum object size	128*128 pixel
Tracking speed	32 pixel/frame
Object memory time	100 frames (4s)
The mean square root values of pulse noise in the object position	< 0.5 pixel

### Thermal Imager Spec

Lens size	25mm
Horizontal FOV	24.6°
Vertical FOV	18.5°
Diagonal FOV	30.4°
Detective Distance (Man: 1.8x0.5m)	735 meters
Recognize Distance (Man: 1.8x0.5m)	184 meters
Verified Distance (Man: 1.8x0.5m)	92 meters
Detective Distance (Car: 4.2x1.8m)	2255 meters
Recognize Distance (Car: 4.2x1.8m)	564 meters
Verified Distance (Car: 4.2x1.8m)	282 meters
Working mode	Uncooled long wave (8 $\mu$ m~14 $\mu$ m) thermal imager
Detector pixel	640*480
Pixel size	17 $\mu$ m
Focusing method	Athermal prime lens
Emissivity correction	0.01~1
NETD	$\leq$ 50mK (@25 $^{\circ}$ C)
MRTD	$\leq$ 650mK (@characteristic frequency)

Image enhancement	Auto adjust image brightness and contrast ratio
Color palette	White, iron red, pseudo color
Auto Non-uniform correction	Yes (no shutter)
Digital zoom	1x ~ 4x
Sync correct time	Yes
Thermometry type	Temperature bar (psudo color display) max temp, min temp, FOV center temp (Optional)
Temperature warning	0℃~120℃ (For thermometry version only)
<b>Thermal Imager Object Tracking</b>	
Update rate of deviation pixel	50Hz
Output delay of deviation pixel	5ms
Minimum object size	32*32 pixel
Maximum object size	128*128 pixel
Tracking speed	32 pixel/frame
Object memory time	100 frames (4s)
<b>Packing Information</b>	
N.W.	1159g/1196g(Viewport Version)

Product meas.	127*122*201mm(including control box)/ 127*122*205mm(Viewport Version)
Accessories	1pc gimbal camera device, screws, copper cylinders, damping balls, damping boards, 1pc USB to TTL cable / High quality plastic box with foam cushion

## 5. FAQ

1. How to deal with whitening visible image of U30TIR in foggy weather?

A: Enable defogging mode.

2. Does U30TIR support taking photos during recording?

A: Yes.

3. How to set the storage format of U30TIR?

A: When the IP output resolution is set to 1280\*720, the storage resolution is 1920 \* 1080; Storage resolution is 1280 \* 720 when the IP output resolution is set to 1920\*1080; The video frame rate saved in the TF card is the same with the one set during IP output. The frame rate is 25fps or 30fps for optional.

4. Does U30TIR support simultaneous TCP control for multiple devices?

A: Yes.