

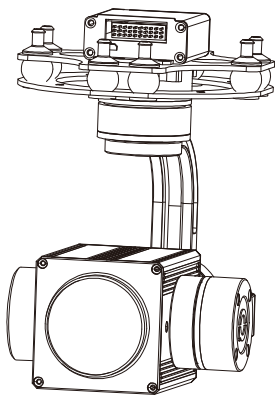

Z18F 18x Optical Zoom Gimbal Camera User Manual

User Manual

使用说明



Standard Version

标准版

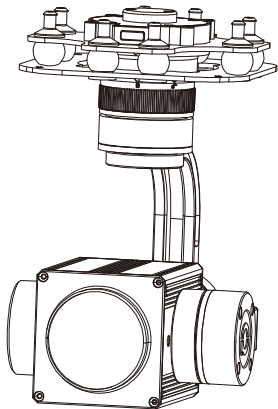

Viewport Version

快拆版



For more details please scan the QR code
or visit our website:

www.viewprotech.com

Disclaimer and Warning

Congratulations on purchasing your new Viewpro product. Please read this entire document carefully. Failure to read or follow instructions and warnings in this document may result in damage to your Viewpro product. Disassemble the gimbal camera by user is not permitted, as which may cause the camera does not work normally. Viewpro accepts no liability for damage, injury or any legal responsibility incurred directly or indirectly from the use of this project. The user shall observe safe and lawful practices including, but no limited to, those set forth in the manual.

Legends



Warning



Important Note







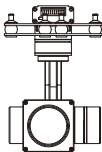
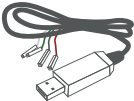

1.Product Introduction

1.1 Introduction

Z18F is a gimbal camera with 3 axis, 18x optical zoom lens, effective 4 mega pixels. It features light and compact, metal housing and anti-interference. The 3 axis gimbal can achieve stabilization in yaw, roll and pitch. The integrated design of damping system and gimbal can greatly reduce mechanical vibration.

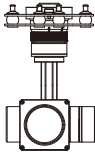
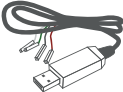
Z18F is widely used in UAV industries of public security, electric power, firefighting, zoom aerial photography and more.

1.2 In the Box

A. Standard Version			
Gimbal Camera x 1 pc		USB to TTL Cable x 1 pc	
Copper Cylinder x 4 pcs		M3 Screw x 8 pcs	
Power Cable x 1 pc			
B. Viewport Version			
Gimbal Camera x 1 pc		USB to TTL Cable x 1 pc	
Copper Cylinder x 4 pcs		M3 Screw x 8 pcs	
Power Cable x 1 pc			
PWM Control Cable x 1 pc			

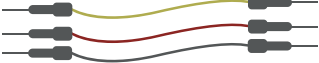
TTL / S.BUS Control Cable x 1 pc	
TTL Connect Cable x 3 pcs	

2. Installation Instruction

2.1 Overview

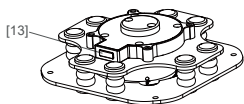
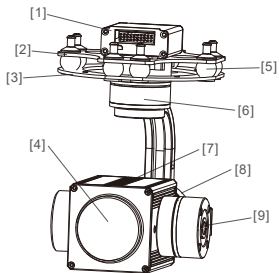

Viewport

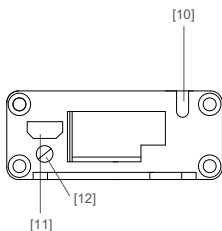

Control Box Back Side
(Standard Version)

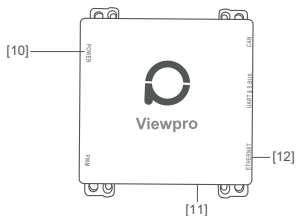

(Viewport Version)

- | | |
|-------------------------|-----------------------------|
| [1] Control box | [8] Roll axis motor |
| [2] Upper damping board | [9] Pitch axis motor |
| [3] Lower damping board | [10] 3-6S power interface |
| [4] FHD zoom camera | [11] Micro HDMI interface |
| [5] Damping ball | [12] Ethernet interface |
| [6] Yaw axis motor | [13] Viewport unlock button |
| [7] TF card slot | |



- Please ensure that there isn't any obstacle while the motor rotating.
- Please remove the obstacle immediately if gimbal camera is blocked during rotation.

2.2.1 Control Box Printing (Standard Version)

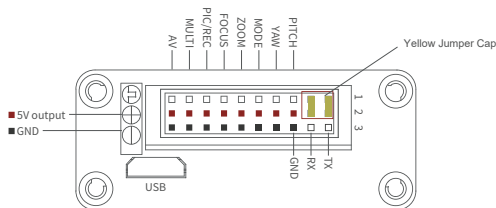

- The input voltage cannot be higher than 6S.
- The pin insertion interface cannot be connected with power supply.
- The yellow jumper cap cannot be removed

2.2.2 Control Box Printing (Viewport Version)



Front Side

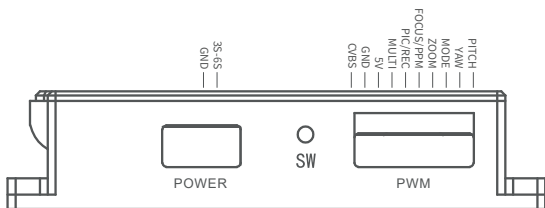

Left Side

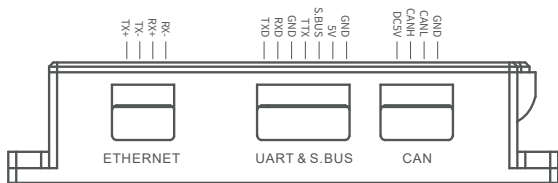

Right Side

2.3 Device Dimensions (Standard Version)

Unit: mm

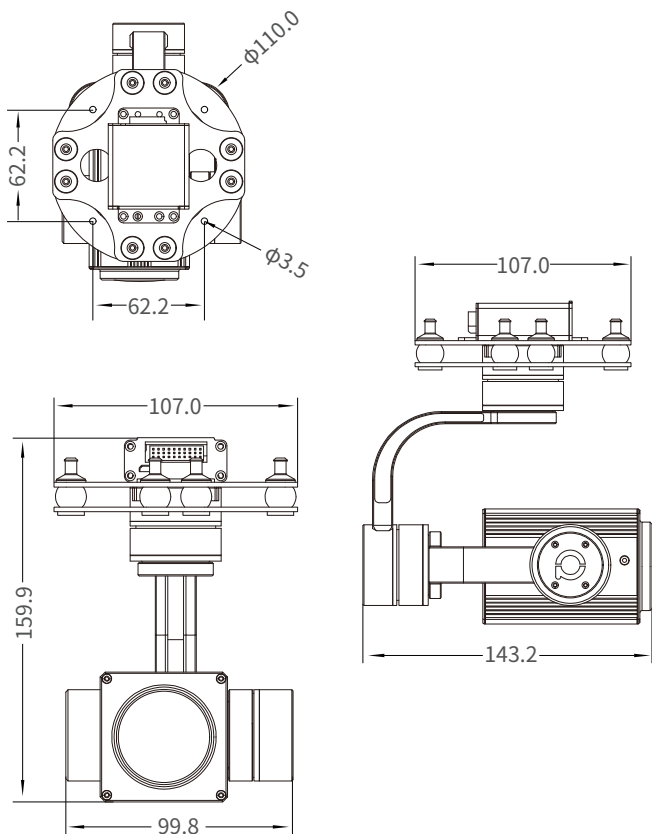

2.3 Device Dimensions (Viewport Version)

Unit: mm

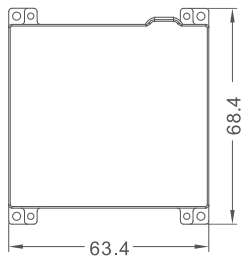
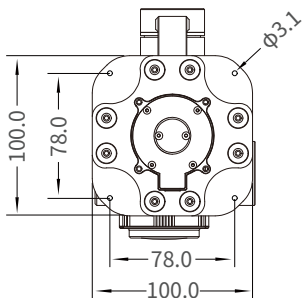

Control Box

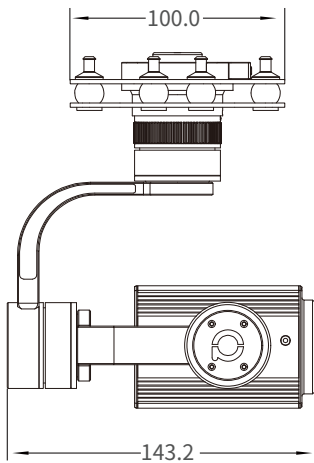
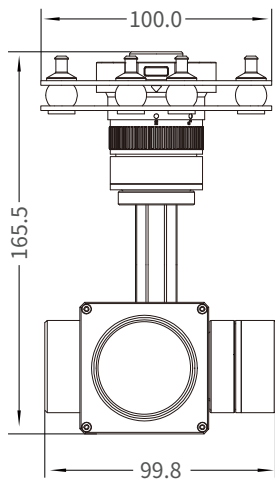

2.4 Install Mounting Part

- (1) Find out the arrow on the gimbal which indicating the yaw heading of the payload (i.e. the lens direction when the camera power on), and synchronize with the direction specified by the UAV.
- (2) Fix one end of the copper cylinder on the screw hole of lower damping board, and use M3 screw to fasten it.
- (3) According to the provided screw hole dimension you can make suitable mounting holes on the UAV mounting board, and fixes the other end of the copper cylinder on the mounting board of the UAV (Viewport version is the same).

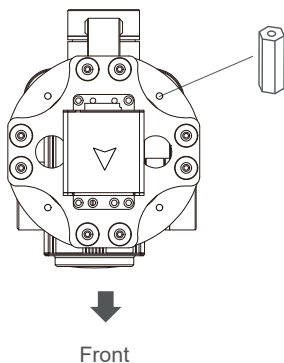

2.5 Viewport Release Instruction

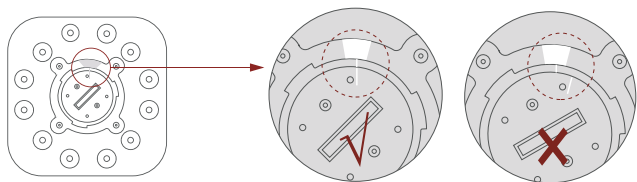
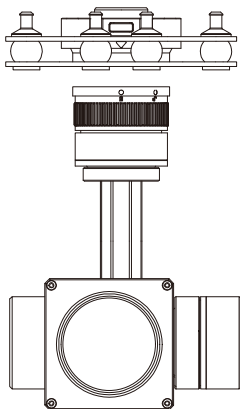

1. Make sure the two white stripes indicated in above picture are aligned with each other. (If the stripes are not aligned to each other, please pinch the connector part and turn it to left manually)

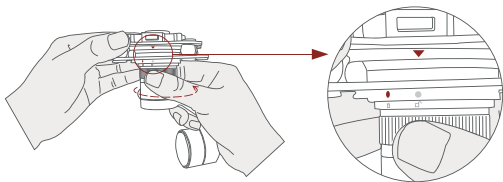

2. Align the white dot (unlock icon) to the red triangle (below unlock button), push the gimbal into the Viewport completely and then rotate the gimbal camera anticlockwise.

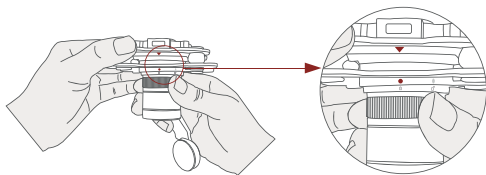

3. When you hear "click" sound (when red dot is aligned to the red triangle) means the gimbal camera and Viewport has been locked.

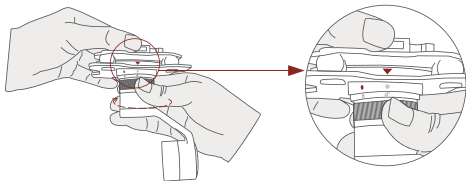

4. To unlock the Viewport, you need to press on unlock button and rotate the gimbal camera clockwise till the white dot align to the red triangle. Then pull the gimbal out from the Viewport.

2.6 Install TF Card

TF (Micro SD card): Install the TF card to the card slot (Re. 2.1 Overview). Support max 32GB. Request Class 10 (10m/s) transmission speed or higher and FAT32 or exFAT format.



- Make sure device is power off when inserting the TF card, hot plugging is not supported.
-

2.7 Image Output Interface

HDMI: micro HDMI output, FHD 1080P 60fps as default

AV: analog signal output, connect with pins AV and GND (Re. 2.1 Overview)

3. Signal Control

3.1 PWM Control

Control the gimbal camera functions by the multiplex pulse width modulation signal outputted by PWM channel of the remote control receiver. The camera needs up to 6 control channels of PWM (to expand tracking function use up to 7 PWM channels). You can choose needed functions according to actual usage to reduce the required number of PWM channels.

3.1.1 PWM Connection Diagram (Connect pitch channel as example)

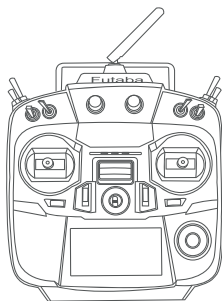

Remote Controller

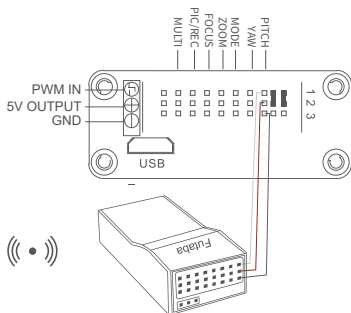

Receiver

Connection Diagram
(Standard Version)



Remote Controller

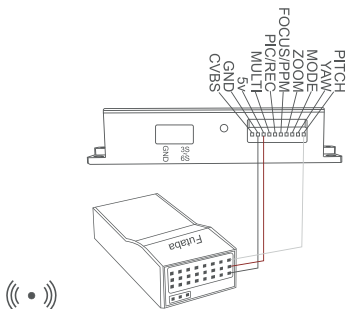

Receiver

Connection Diagram
(Viewport Version)

3.1.2 PWM Control Operation Instruction

1) Pitch (PWM Pitch channel in to control Pitch. Joystick, rotary knob or 3-gear switch on remote control are optional. 3-gear switch as example.)



Position 1

Low Gear
Pitch Up



Position 2

Middle Gear
Pitch Stop



Position 3

High Gear
Pitch Down

2) Yaw (PWM Yaw channel in to control Yaw. Joystick, rotary knob or 3-gear switch on remote control are optional. 3-gear switch as example.)



Position 1

Low Gear
Yaw Left



Position 2

Middle Gear
Yaw Stop



Position 3

High Gear
Yaw Right

3) Mode (PWM Mode channel in to adjust speed control/one key to Home position etc functions. Rotary knob or 3-gear switch on remote control are optional. 3-gear switch as example.)



Position 1

Low Gear



Position 2

Middle Gear



Position 3

High Gear

Position 1: Low speed mode, control pitch / yaw with this mode at lowest speed

Position 2: Middle speed mode, control pitch / yaw with this mode at middle speed

Position 3: High speed mode, control pitch / yaw with this mode at highest speed

(If it is controlled by rotary knob, the speed will change according to switch position)

Function of continuous switching:

3.1) Operate 1 time continuously and quickly, from position 2 - 3 - 2, to Home position.

3.2) Operate 2 times continuously and quickly, from position 2 - 3 - 2 - 3 - 2, the camera lens looks vertically down.

3.3) Operate 3 times continuously and quickly, from position 2 - 3 - 2 - 3 - 2 - 3 - 2, to disable Follow Yaw Mode (gimbal yaw not follows by frame)

3.4) Operate 4 times continuously and quickly, from position 2 - 3 - 2 - 3 - 2 - 3 - 2 - 3 - 2, to enable Follow Yaw Mode (gimbal yaw follows by frame)

4) Zoom (PWM Zoom channel in to control Zoom. Joystick, rotary knob or 3-gear switch on remote control are optional. 3-gear switch as example.)



Position 1

Low Gear
Zoom Out



Position 2

Middle Gear
Stop Zoom



Position 3

High Gear
Zoom In

5) Focus (PWM Focus channel in to control Manual Focus, default auto-focus mode. 3-gear switch on remote control are optional. 3-gear switch as example.)



Position 1

Low Gear



Position 2

Middle Gear



Position 3

High Gear

6) Pic/Rec (PWM Pic/Rec channel in to control take picture and record. Joystick, rotary knob or 3-gear switch on remote control are optional. 3-gear switch as example.)



Position 1

Low Gear



Position 2

Middle Gear



Position 3

High Gear

Switch from Position 2 to 1:

Photograph / Record:

- Picture mode: from 2 to 1, take a picture.
- Record mode: from 2 to 1, start record, repeat operation to stop record.

Switch from Position 2 to 3:

Picture / Record Mode Switch

- Picture mode: the number is picture quantity that SD card can store.
- Record mode: the time is recording time.

7) **Multi:** backup PWM channel, no control

3.2 Serial Port / TTL Control

TTL communication requirements: TTL signal is 3.3V, baud rate: 115200, data bit 8, stop bit 1, no parity, HEX send and receive.

Connection Diagram (PC - USB to TTL Cable- Gimbal Camera as example):

Gimbal Camera	Cable
TX	↔ RX (White)
RX	↔ TX (Green)
GND	↔ GND (Black)

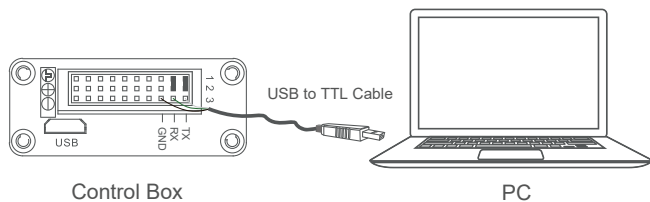

Connection Diagram Standard Version

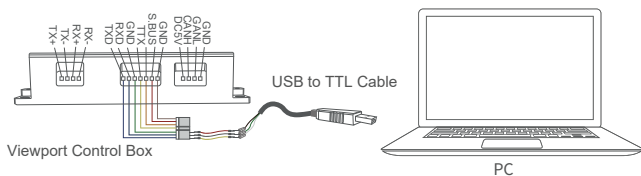

Connection Diagram Viewport Version

Diagram of USB to TTL Cable:

Connect the camera to the upper computer by USB to TTL cable (Adopt connection method of TX to RX, RX to TX, GNG to GND at Dupont ends of the provided USB to TTL cable, connect to the specified TTL of the gimbal, and the USB end of the cable connect to computer).

Install Viewlink control software to test the functions directly. Users may choose to develop their own software, please contact technical support for TTL control protocol file.

ViewLink is a user interface developed by Viewpro for Viewpro gimbal cameras, you can download it from Viewpro website (www.viewpro-tech.com) or ask distributors for installation package.



- Connect serial port of gimbal to pins, DO NOT connect with power supply.



- The default baud rate of serial port is 115200, which can be changed according to the docking equipment.

3.3 S.BUS Control

Control the gimbal camera functions by one combining signals. Connect the external S.Bus to S.Bus port on the control box, and the external S.bus signal GND connect to the GND interface of the control box.

Wiring Diagram (Take Futaba remote control for example):

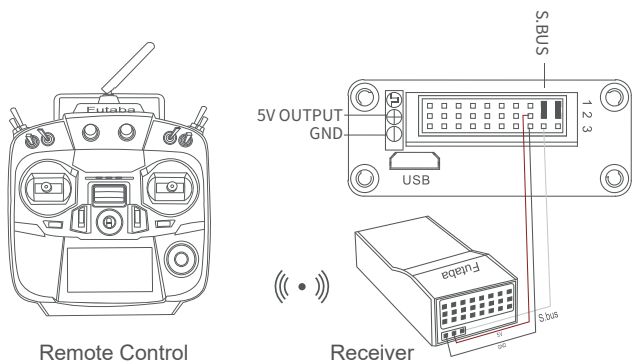

Wiring Diagram Standard Version

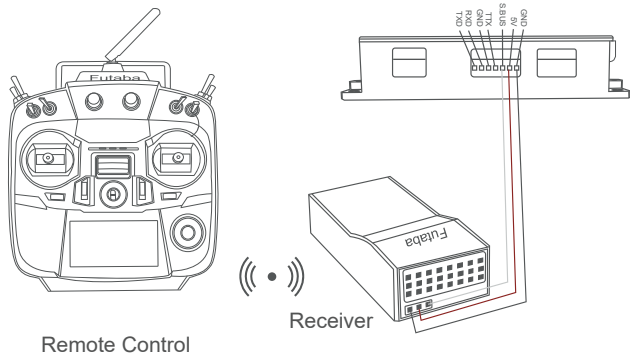

S.Bus control mode: default S.Bus signal channel 9-15 to control gimbal camera functions (the function of channel is consistent with corresponding channel in PWM function description)

Channel 9: Yaw Control

Channel 10: Pitch Control

Channel 11: Mode Control

Channel 12: Zoom Control

Channel 13: Focus Control

Channel 14: Pic/Rec Control

Channel 15: Multi Backup



•User can set the channels by setting serial command according to the actual requirement. The S.Bus channel position can be arranged in any sequence within channel 1-15 to connect with the flight controller or remote control.

4. Specification

General	
Working voltage	12V
Input voltage	3S ~ 6S
Output voltage	5V (connect with PWM)
Dynamic current	400mA @ 12V
Idle current	240mA @ 12V
Working environment temp.	-20 to 60℃
Output	micro HDMI(HD output 1080P 60fps)
Local-storage	SD card (Up to 32G, class 10, FAT32 or ex FAT format)
Photo storage format	JPG (1920*1080)
Video storage format	MOV (1080P 30fps)
Control method	PWM / S.bus / TTL

Gimbal Spec

Mechanical Range	Pitch/Tilt: $\pm 160^\circ$, Roll: $\pm 70^\circ$, Yaw/Pan: $\pm 300^\circ$
Controllable Range	Pitch/Tilt: $-45^\circ \sim 90^\circ$, Yaw/Pan: $\pm 290^\circ$
Vibration angle	Picth/Roll: $\pm 0.02^\circ$, Yaw: $\pm 0.03^\circ$
One-key to center	√

Camera spec

Imager Sensor	1/3inch CMOS
Total pixel	4MP
Effective pixel	2688*1520
Dynamic range	65dB
Optical zoom	18x, F=4.7~84.6mm
Min object distance	1.5M
Viewing angle	Horizontal: 54.8° (Wide end) $\sim 3.4^\circ$ (Tele end) Vertical: 41° (wide end) $\sim 2.5^\circ$ (tele end)
Sync system	Progressive scanning
Local video	1080P 30fps local TF card
HD output	1080P/720/480P 60fps HDMI1.4
AV output	Standard CVBS 1Vp-p
S/N ratio	38dB
Min illumination	Color 0.05lux@F1.6

Backlight compensation	Backlight compensation/strong light inhibition
Gain	Auto
White balance	Auto/Manual
Shutter speed	Auto
Control system	UART/IR/PWM
Communication protocol	PELCO-D, Hitachi protocol or VISCA
Focus	Auto/Manual/One-time automatic focus
Focus speed	2s
Lens initialization	Built-in
User presetting bit	20 sets
Image rotation	180°, Horizontal/Vertical mirror image
OSD	Not support
Object Tracking(Optional)	
Update rate of deviation pixel	50Hz
Output delay of deviation pixel	5ms
Minimum object contrast	5%
SNR	4
Minimum object size	32*32 pixel

Maximum object size	128*128 pixel
Tracking speed	32 pixel/frame
Object memory time	4s
The mean square root values of pulse noise in the object position	< 0.5 pixel
Packing Information	
N.W.	695g
Product meas.	144*85*134mm
Accessories	1pc gimbal camera device, 16pcs screws, 4pcs copper cylinders, 12pcs damping balls, 4pcs damping boards / box

5. FAQ

1. What outputs that Z18F supports?

A: HDMI 1080p 60fps(default) / HDMI 1080p 30fps, compatible with analog output.

2. Z18F cannot store pictures and videos?

A: Please make sure a TF card should be put into the specified card slot in the camera, and the standard of TF card is selected correctly. (Requirements: max capacity of 32G, class10 and above transmission speed, FAT32 or ex FAT format). If there are still problems, please format the TF card.

3. Does Z18F support taking photos during recording?

A: No, not support. Z18F has photo mode and record mode. You need to switch to photo mode to take picture.

4. What is the focusing mode of Z18F?

A: The camera can auto focus or manually.