

Navigator®

OWNER'S MANUAL



**PORTABLE
GENERATOR**
MODEL NUMBER
NG2500
NG3500
NG3500E2
NG8500E2
NG9500E2

IMPORTANT: Read all safety precautions and instructions carefully before operating equipment.



Ensure engine is stopped and level before performing any maintenance or service.

Record product information to reference when ordering parts or obtaining warranty coverage.

Serial Number: _____

Purchase Date: _____

P/N:323745451 Rev:01

Table of Contents

Introduction	1	Maintenance And Storage	21
Safety Precautions	2	Maintenance Schedule	21
Unpacking the Generator	6	Engine Maintenance	22
Parts Included	6	Change Engine Oil	22
Removal Of Shipping Supports	7	Air Filter Maintenance	22
Assembly	8	Spark Plug Maintenance	23
Install the Wheel Kit	8	Cleaning Fuel Strainer	23
Install the Support Leg	8	Inspect Muffler	23
Install the Handle	8	Generator Maintenance	24
Battery Cable Connection	9	Battery Replacement	24
Controls and Features	10	Service and Storage	25
Generator	10	Trouble Shooting	27
Control Panel	11		
Specifications	12		
Add Engine Oil	13		
Low Oil Shutdown	13		
Add Fuel	14		
Grounding	15		
Connecting to a Building's Electrical System	15		
Operation	16		
Generator Location	16		
Surge Protection	16		
Starting the Generator (Recoil Start)	17		
Starting the Generator (Electric Start)	18		
Connecting Electrical Loads	19		
Stopping the Engine	20		
Low Oil Shutdown	20		
Do Not Overload Generator	20		

INTRODUCTION

Thank you for purchasing a Navigator generator.











This manual contains safety information to make you aware of the hazards and risks associated with generator products and how to avoid them. This generator is designed and intended only for supplying electrical power for operating compatible electrical lighting, appliances, tools and motor loads, and is not intended for any other purpose. It is important that you read and understand these instructions thoroughly before attempting to start or operate this equipment.

Save these original instructions for future reference.



This manual covers operation and maintenance of the Navigator generators. All information in this publication is based on the latest production information available at the time of approval for printing. The manufacturer reserves the right to change, alter or other wise improve the generator and this documentation at any time without prior change.

Important Safety Information

The manufacturer cannot possibly anticipate every possible circumstance that might involve a hazard. The warnings in this manual and the tags and decals affixed to the unit are therefore not all-inclusive. If you use a procedure, work method or operating technique that the manufacturer does not specifically recommend you must satisfy yourself that it is safe for you and others. You must also make sure that the procedure work method or operating technique that you choose does not render the generator unsafe.

SAFETY INFORMATION		
 DANGER	 WARNING	 CAUTION
<p>DANGER indicates a potentially hazardous situation which, if not avoided, WILL result in death or serious injury.</p>	<p>WARNING indicates a potentially hazardous situation which, if not avoided, could result in death or serious injury.</p>	<p>CAUTION indicates a potentially hazardous situation which, if not avoided, may result in minor or moderate personal injury, or property damage.</p>
 Toxic Fumes	 Risk of Electric Shock	
 Fire Hazard	 Explosion Hazard	
 Hot Surface. Do Not Touch the Surface.	 Rotating Parts Entanglement Hazard	
 Kickback	 Operator's Manual	

SAFETY PRECAUTIONS

⚠ DANGER	
Using a generator indoors CAN KILL YOU IN MINUTES . Generator exhaust contains carbon monoxide. This is a poison you cannot see or smell.	
 NEVER use inside a home or garage, EVEN IF doors and windows are open.	 Only use OUTSIDE and far away from windows, doors, and vents.
Avoid other generator hazards. READ MANUAL BEFORE USE.	

⚠ WARNING **POISONOUS GAS HAZARD.**



Engine exhaust contains carbon monoxide, a poisonous gas that could kill you in minutes. You **CANNOT** smell it, see it, or taste it. Even if you do not smell exhaust fumes, you could still be exposed to carbon monoxide gas.

- Operate this product **ONLY** outside far away from windows, doors and vents to reduce the risk of carbon monoxide gas from accumulating and potentially being drawn towards occupied spaces.
- Install battery-operated carbon monoxide alarms or plug-in carbon monoxide alarms with battery back-up according to the manufacturer's instructions. Smoke alarms cannot detect carbon monoxide gas.
- **DO NOT** run this product inside homes, garages, basements, crawlspaces, sheds, or other partially-enclosed spaces even if using fans or opening doors and windows for ventilation. Carbon monoxide can quickly build up in these spaces and can linger for hours, even after this product has shut off.
- **ALWAYS** place this product downwind and point the engine exhaust away from occupied spaces. If you start to feel sick, dizzy, or weak while using this product, shut it off and get to fresh air **RIGHT AWAY**. See a doctor. You may have carbon monoxide poisoning.

⚠ WARNING

The engine exhaust from this product contains chemicals to cause cancer, birth defects, or other reproductive harm.

⚠ WARNING

Certain components in this product and related accessories contain chemicals known to the State of California to cause cancer, birth defects or other reproductive harm. Wash hands after handling.

- If you start to feel sick, dizzy or weak while using the portable generator, you may have carbon monoxide poisoning. Get out side to fresh air immediately and call 911 for emergency medical attention. Very high levels of CO can rapidly cause victims to lose consciousness before they can rescue themselves. **DO NOT** attempt to shut off the generator before moving to fresh air. Entering an enclosed space where a generator is or has been running may put you at greater risk of CO poisoning.

CORRECT USAGE

Example location to reduce risk of carbon monoxide poisoning

- ONLY use outside and downwind, far away from windows, doors and vents.
- Direct exhaust **AWAY** from windows, doors, and vents.

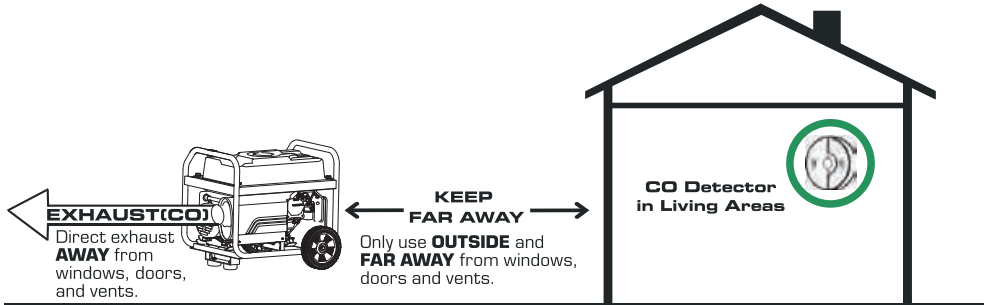

INCORRECT USAGE

Do not operate in any of the following locations:

- Near any door, window or vent
- Garage
- Basement
- Crawl Space
- Living Area
- Attic
- Entry Way
- Porch
- Mudroom

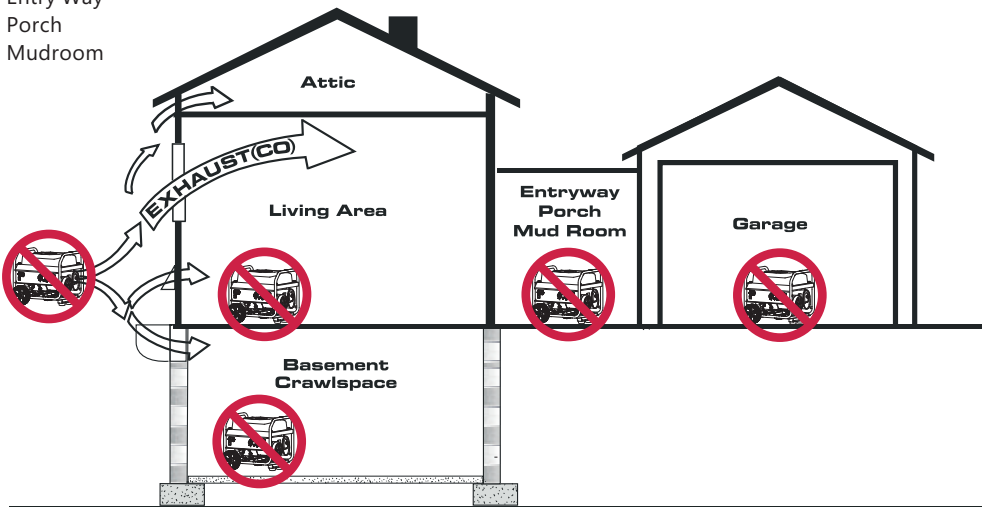

WARNING



Starter cord kickback (rapid retraction) will pull hand and arm toward engine faster than you can let go which could cause broken bones, fractures, bruises, or sprains resulting in serious injury.

- When starting engine, pull cord slowly until resistance is felt and then pull rapidly to avoid kickback.
- **NEVER** start or stop engine with electrical devices plugged in and turned on.

WARNING



Fuel and its vapors are extremely flammable and explosive which could cause burns, fire, or explosion resulting in death or serious injury and/or property damage.

WHEN ADDING OR DRAINING FUEL

- Turn generator engine OFF and let it cool at least 2 minutes before removing fuel cap. Loosen cap slowly to relieve pressure in tank.
- Fill or drain fuel tank outdoors.
- **DO NOT** overfill tank. Allow space for fuel expansion.
- If fuel spills, wait until it evaporates before starting engine.
- Keep fuel away from sparks, open flames, pilot lights, heat, and other ignition sources.
- Check fuel lines, tank, cap, and fittings frequently for cracks or leaks. Replace if necessary.
- **DO NOT** light a cigarette or smoke.

WHEN STARTING EQUIPMENT

- Ensure spark plug, muffler, fuel cap, and air cleaner are in place.
- **DO NOT** crank engine with spark plug removed.

WHEN OPERATING EQUIPMENT

- **DO NOT** operate this product inside any building, carport, porch, mobile equipment, marine applications, or enclosure.
- **DO NOT** tip engine or equipment at angle which causes fuel to spill.
- **DO NOT** stop engine by moving choke control to "Start" position.

WHEN TRANSPORTING, MOVING OR REPAIRING EQUIPMENT

- Transport/move/repair with fuel tank EMPTY or with fuel shutoff valve OFF.
- **DO NOT** tip engine or equipment at angle which causes fuel to spill.
- Disconnect spark plug wire.

WHEN STORING FUEL OR EQUIPMENT WITH FUEL IN TANK

- Store away from furnaces, stoves, water heaters, clothes dryers, or other appliances that have pilot light or other ignition source because they could ignite fuel vapors.

WARNING



Generator voltage could cause electrical shock or burn resulting in death or serious injury.

- Use approved transfer equipment, suitable for the intended use, to prevent backfeed by isolating generator from electric utility workers.
- When using generator for backup power, notify utility company.
- Use a ground fault circuit interrupter (GFCI) in any damp or highly conductive area, such as metal decking or steel work.
- **DO NOT** touch bare wires or receptacles.
- **DO NOT** use generator with electrical cords which are worn, frayed, bare or otherwise damaged.
- **DO NOT** operate generator in the rain or wet weather.
- **DO NOT** handle generator or electrical cords while standing in water, while barefoot, or while hands or feet are wet.

- **DO NOT** allow unqualified persons or children to operate or service generator.

WARNING



Exhaust heat/gases could ignite combustibles, structures or damage fuel tank causing a fire, resulting in death or serious injury and/or property damage.

Contact with muffler area could cause burns resulting in serious injury.

- **DO NOT** touch hot parts and **AVOID** hot exhaust gases.
- Allow equipment to cool before touching.
- It is a violation of California Public Resource Code, Section 4442, to use or operate the engine on any forest-covered, brush-covered, or grass-covered land unless the exhaust system is equipped with a spark arrester, as defined in Section 4442, maintained in effective working order. Other states or federal jurisdictions may have similar laws. Contact the original equipment manufacturer, retailer, or dealer to obtain a spark arrester designed for the exhaust system installed on this engine.
- Replacement parts must be the same and installed in the same position as the original parts.

WARNING



Unintentional sparking could cause fire or electric shock resulting in death or serious injury.

WHEN ADJUSTING OR MAKING REPAIRS TO YOUR GENERATOR

- Disconnect the spark plug wire from the spark plug and place the wire where it cannot contact spark plug.

WHEN TESTING FOR ENGINE SPARK

- Use approved spark plug tester.
- **DO NOT** check for spark with spark plug removed.

WARNING



Starter and other rotating parts could entangle hands, hair, clothing, or accessories resulting in serious injury.

- **NEVER** operate generator without protective housing or covers.
- **DO NOT** wear loose clothing, jewelry or anything that could be caught in the starter or other rotating parts.
- Tie up long hair and remove jewelry.

CAUTION

Excessively high operating speeds could result in minor injury. Excessively low operating speeds impose a heavy load.

- **DO NOT** tamper with governor spring, links or other parts to increase engine speed. Generator supplies correct rated frequency and voltage when running at governed speed.
- **DO NOT** modify generator in any way.

NOTE:

Exceeding generators wattage/amperage capacity could damage generator and/or electrical devices connected to it.

- **DO NOT** exceed the generator's wattage amperage capacity.
- Start generator and let engine stabilize before connecting electrical loads.
- Connect electrical loads in OFF position, then turn ON for operation.
- Turn electrical loads OFF and disconnect from generator before stopping generator.

NOTE:

Improper treatment of generator could damage it and shorten its life.

- Use generator only for intended uses.
- If you have questions about intended use, ask dealer or contact local service center.
- Operate generator only on level surfaces.
- **DO NOT** expose generator to excessive moisture, dust, dirt, or corrosive vapors.
- **DO NOT** insert any objects through cooling slots.
- If connected devices overheat, turn them off and disconnect them from generator.

- Shut off generator if:
 - Electrical output is lost.
 - Equipment sparks, smokes, or emits flames.
 - Unit vibrates excessively.

⚠ WARNING

Medical and Life Support Uses.

- NEVER use this product to power life support devices or life support appliances.
- NEVER use this product to power medical devices or medical appliances.
- Inform your electricity provider immediately if you or anyone in your household depends on electrical equipment to live.
- Inform your electrical provider immediately if a loss of power would cause you or anyone in your household to experience a medical emergency.

UNPACKING THE GENERATOR

- Open carton and Remove packaging materials.
- Remove generator, accessories boxes, and literature from carton. If any items are missing or damaged, contact our product service department at 0098625 84531706.

Parts Included

Your gasoline powered generator ships with the following parts:

1. Axle pin	2
2. Wheel	2
3. Flat Washer	2
4. Cotter pin	2
5. Wrench for Spark plug	1
6. Double Open wrench (10mm & 12mm)	1
7. Handle Pin	1
8. Cotter Pin	1
9. Handle	1
10. Support Leg with Vibration Mounts	1
11. Flange Bolt (M8x16 for Support Leg)	2
12. Flange Lock Nut (M8)	4
13. Manual	1
14. Quick Reference Guide	1

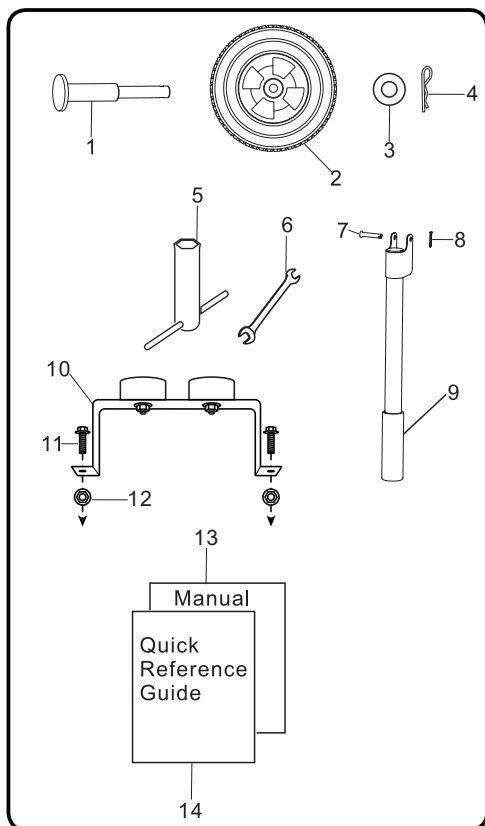

REMOVAL OF SHIPPING SUPPORTS

Before you can run your new generator, follow these simple instructions:

The following items must be removed before running your new generator. In order to protect your generator these items have been added to ensure safe delivery of your new generator.

CAUTION

Failure to remove these items can result in damage to your generator, possible Personal injury and void your warranty.

Refer to the following instructions and pictures to remove the attached engine support brackets (red) under the engine.

1. Before filling the engine oil, tip the generator back onto its recoil frame end as indicated in this picture. Place the generator on the flattened cardboard box or other protective surface.

2. Remove the indicated bolts and nuts from the red engine support brackets. You may use the appropriate wrenches provided.

3. You may discard these brackets, as it is no longer required for normal operation of your generator.

Your generator is now ready for use. Refer to your owner's manual for proper oil fill and startup instructions.

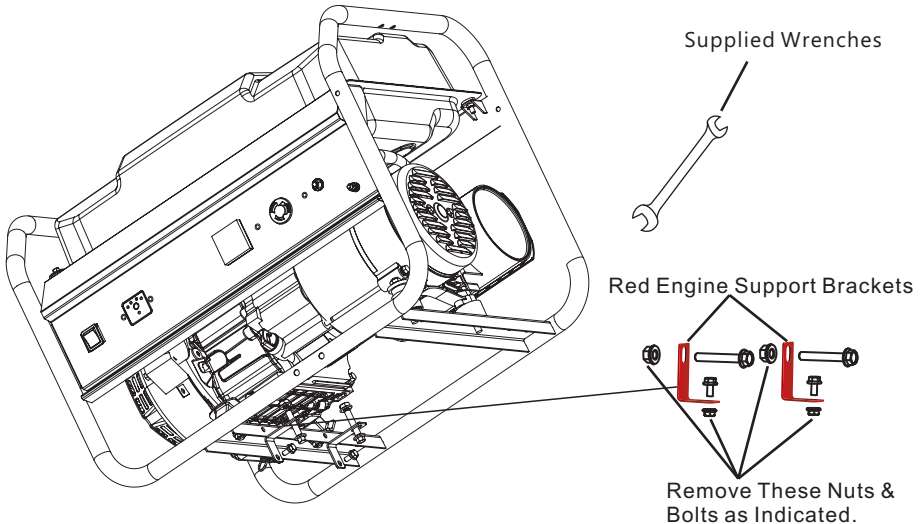

ASSEMBLY

The generator requires some assembly prior to usage. If problems arise when assembling the generator, call

Install the Wheel Kit



The wheel kit is not intended for over-the-road use.

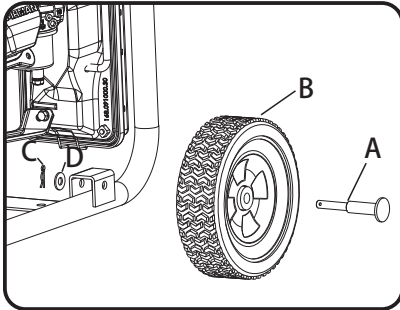

1. Before adding wheels, tip the generator on its side.
2. Slide the axle pin A through the wheel B.
3. Slide the axle pin A through the mount point on the frame and flat washer D.
4. Secure the wheel and axle pin with the cotter pin C.
5. Repeat steps 2-4 to attach another wheel.

Install the Support Leg

1. Attach the support leg G to the generator frame with flange bolts E (M8x16) and flange lock nuts F (M8).
2. Tip the generator slowly so that it rests on the wheels and support leg.
3. Tighten bolt E and nut F with provide wrenches.

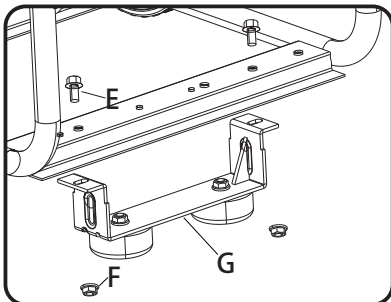

Install the Handle

1. Place the handle K over the mounting channel on the frame.
2. Slide the handle pin F through the mount point on the frame.
3. Secure the handle and handle pin with the cotter pin H.
4. Replace the step 2 and 3 to attach another handle.

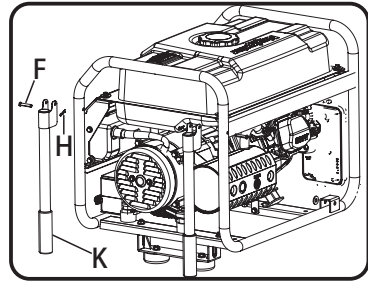

Battery Cable Connection

You will need to use 8mm box wrenches to connect the battery cables to battery.

NOTE:

The generator comes equipped with the positive red cable(red cable) already attached.

1. Verify the positive (+) battery cable (red boot) is securely tightened to the positive (+) battery post. Make sure boot is over battery post.
2. Remove bolt M5X10 and M5 nut from black cable ring.

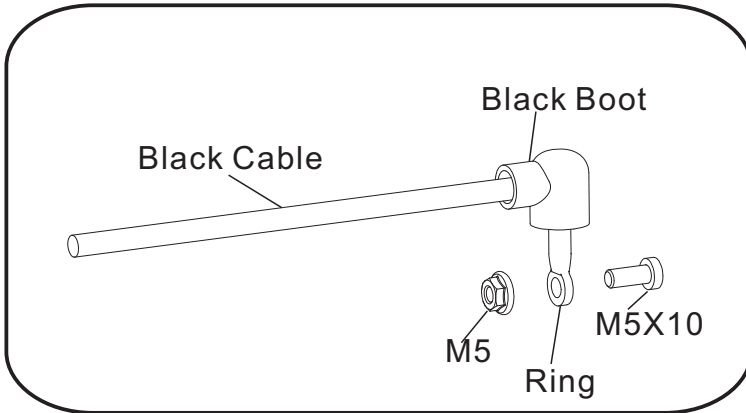

3. Remove vinyl cap from the negative(-) battery post. Locate negative (-) black cable and route to the negative(-) battery post. Tight the cable with bolt M5X10 and M5 nut. Cover the post with black boot.

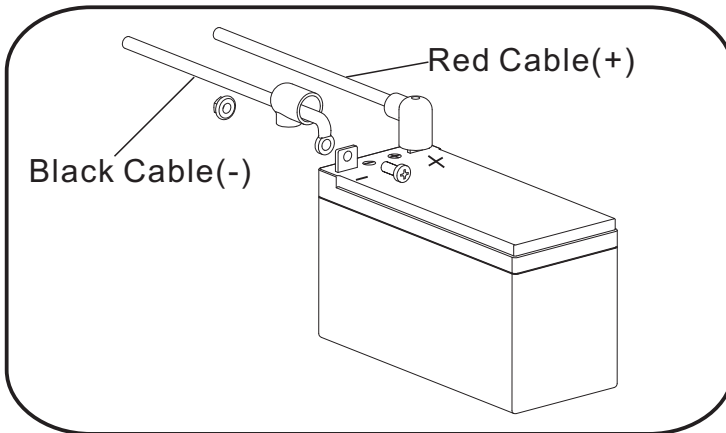

CONTROLS AND FEATURES

Generator

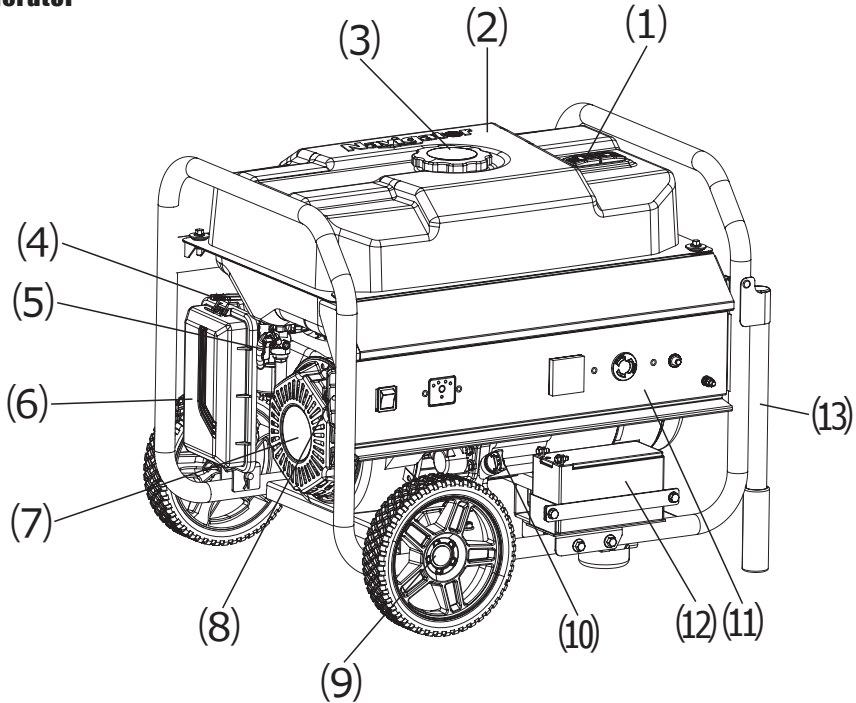

1- Fuel Gauge

2- Fuel Tank

3- Fuel Cap

4- Choke Lever(behind air filter box)

5- Fuel Valve

6- Air Filter

7- NAVIGATOR OHV Engine

8- Recoil Starter

9- Flat Free Wheel

10- Oil Filler Cap

11- Control Panel

12- Battery

13- Handle

*We are always working to improve our products. Therefore, the enclosed product may differ slightly from the image on this page.

Control Panel

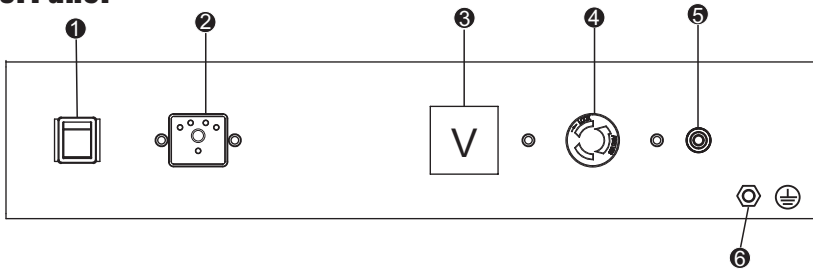

NOTE: Total power drawn from all receptacles must not exceed the name plate rating.

- ❶ **Engine Switch** – Used to start engine from the starter motor (Electric start model only). To start engine, press and hold the switch in the “**START**”(II) position, the engine will crank and attempt to start. When the engine starts, release the switch to the “**RUN**”(I) position.
- ❷ **Time Switch** – Time your generator.
Time switch tech enables you to embrace quality sleep.
Say No to off the gen outside every night and don't worry the risk of robbery and kidnapping meantime.
- ❸ **Volt-Meter** – Show the voltage.
- ❹ **230V, 30A Lock Receptacle**
Maximum full load current may be drawn from this 230 Volt, 30 Amp receptacle.
- ❺ **Circuit Breakers** – The receptacles are protected by an AC circuit protector. If the generator is overloaded or an external short circuit occurs the circuit protector will trip. If this occurs, disconnect all electrical loads and try to determine the cause of the problem before attempting to use the generator again. If overloading causes the circuit protector to trip, reduce the load.
Note: Continuous tripping of the circuit protector may cause damage to generator or equipment. The circuit protector may be reset by pushing the button of the protector.
- ❻ **Ground Terminal** – Consult an electrician for local grounding regulations.

SPECIFICATIONS

Model	NG2500	NG3500	NG3500E2	NG8500E2	NG9500E2
Starting Watts	2600	3200		5500	6500
Running Watts	2300	2900		5000	6000
Rated AC Voltage	230V				
Rated Frequency	50Hz				
Phase	Single				
Voltage Regulator	AVR				
Power Factor	1				
Alternator Type	Brushed				
Engine	NAVIGATOR				
Engine Type	Single Cylinder, 4-Stroke OHV Air Cooled				
Displacement	196cc			439cc	
Low Oil Shutdown	Yes				
Ignition System	Breakless Ignition Type, Flywheel Magneto				
Starting System	Recoil		Recoil/Electric Start		
Fuel	Unleaded Automotive Gasoline				
Capacity Fuel Tank	23L			35L	
Lubricating Oil Capacity	0.6L			1.1L	
Carburetor Type	Float				
Air Cleaner	Polyurethane Type				
P.T.O. Shaft Rotation	Counter Clockwise (Facing P.T.O.)				
Oil Type	See "Add Engine Oil" Section				
Spark Plug	LD F6TC				

AN IMPORTANT MESSAGE ABOUT TEMPERATURE:

Your Firman Power Equipment product is designed and rated for continuous operation at ambient temperatures up to 40°C (104°F). When your product is needed, your product may be operated at temperatures ranging from -15°C (5°F) to 50°C (122°F) for short periods. If the product is exposed to temperatures outside this range during storage, it should be brought back within this range before operation. In any event, the product must always be operated outdoors, in a well-ventilated area and away from doors, windows and other vents.

- When operated above 77°F(25°C) there may be a decrease in power.
- Maximum wattage and current are subject to and limited by such factors as fuel BTU content ambient temperature, altitude, engine condition and etc. Maximum power decreases about 3.5% for each 1,000 feet above sea level; and will also decrease about 1% for each 10°F(-12.2°C) above 60°F(16°C) ambient temperature.

ADD ENGINE OIL

⚠ CAUTION

DO NOT attempt to crank or start the engine before it has been properly filled with the recommended type and amount of oil. Damage to the generator as a result of failure to follow these instructions will void your warranty.

NOTE:

The recommended oil type is 20W-50 automotive oil. However outdoor temperatures determine the space proper oil viscosity for the engine. Use the chart to select the best for the outdoor temperature range expected.

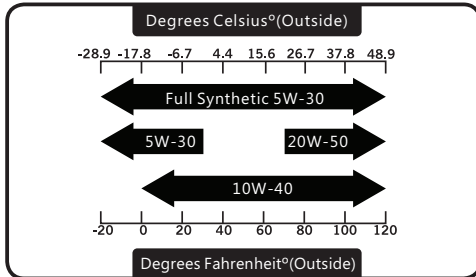

1. Place generator on a flat, level surface.
2. Clean area around oil fill and remove yellow oil fill cap/dipstick.
3. Wipe dipstick clean.

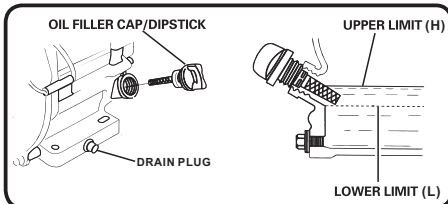
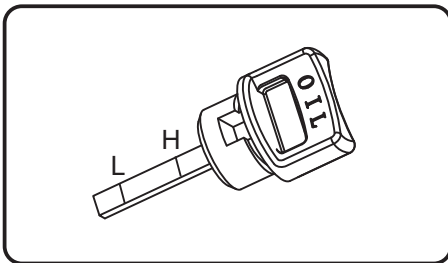

4. Using oil funnel, slowly pour contents of provided oil bottle into oil fill opening to the "H" mark on dipstick. Be careful do not overfill. Overfilling with oil could cause the engine to not start or hard starting.

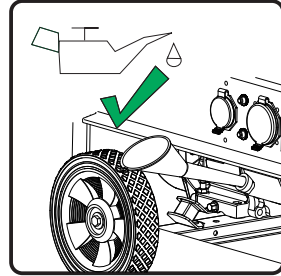

5. Replace oil fill cap/dipstick and fully tighten.
6. Oil level should be checked prior to each use or at least every 8 hours of operation. Keep oil level maintained.

⚠ CAUTION

The engine is equipped with a low oil shut-off and will stop when the oil level in the crankcase falls below the threshold level.

NOTE:

We consider the first 5 hours of run time to be the break-in period for the unit. During the break in period stay at or below 50% of the running watt rating and vary the load occasionally to allow stator windings to heat and cool. Adjusting the load will also cause engine speed to vary and help seat piston rings.

Low Oil Shutdown

The unit is equipped with a low oil shutdown. If the oil level becomes lower than required, the sensor will activate a warning device or stop the engine.

If generator shuts off and the oil level is within specifications, check to see if generator is sitting at an angle that forces oil to shift. Place on an even surface to correct this. If engine fails to start, the oil level may not be sufficient to deactivate low oil level switch. Make sure the sump is completely full of oil.

ADD FUEL

Fuel must meet these requirements:

- Clean, fresh, unleaded gasoline.
- Use regular UNLEADED gasoline with the generator engine with a minimum 87 octane / 87 AKI (91 RON).

For high altitude use, see "Operation at High Altitude".

- Do not use gasoline with more than 10% alcohol such as E85 or ethanol.

NOTE: Avoid generator damage.

Failure to follow Operator's Manual for fuel recommendations voids warranty.

- DO NOT use unapproved gasoline such as E85.
- DO NOT mix oil in gasoline.
- DO NOT modify engine to run on alternate fuels.

WARNING



Fuel and its vapors are extremely flammable and explosive which could cause burns, fire or explosion resulting in death, serious injury and/or property damage.

WHEN ADDING FUEL

- Fill fuel tank outdoors.



DO NOT overfill tank. Allow space for fuel expansion. If the tank is overfilled, fuel can overflow onto a hot engine and cause fire or explosion. Wipe up any spilled fuel immediately.

- If fuel spills, wait until it evaporates before starting engine.
- Keep fuel away from sparks, open flames, pilot lights, heat, and other ignition sources.
- Check fuel lines, tank, cap and fittings frequently for cracks or leaks. Replace if necessary.



DO NOT light a cigarette or smoke when filling the fuel tank.

1. Clean area around fuel fill cap, remove cap.
2. Slowly add unleaded fuel to fuel tank. Be careful not to fill above the red fuel level indicator. This allows adequate space for fuel expansion.
3. Install fuel cap and let any spilled fuel evaporate before starting engine or wipe up any spilled gasoline.

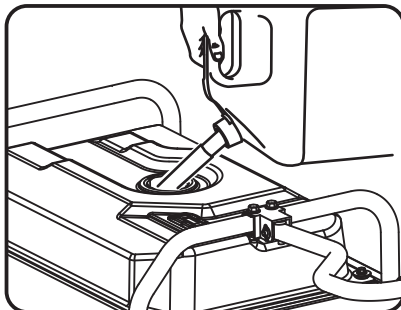

CAUTION

- Slowly add unleaded gasoline to fuel tank.
- Do not overfill tank.
- Do not fill above top of fuel screen. This will allow expansion in hot weather and prevent overflow.



Grounding

The National Electric Code requires your generator must be properly connected to an appropriate ground to help prevent electric shock.

WARNING



Failure to properly ground the generator can result in electric shock.

A ground terminal connected to the frame of the generator has been provided on the control panel. For remote grounding, connect a length of heavy gauge (12 AWG minimum) copper wire between the generator ground terminal and a copper rod driven into the ground. We strongly recommend that you consult with a qualified electrician to ensure compliance with local electrical codes.

THERE IS A PERMANENT CONDUCTOR BETWEEN THE GENERATOR (STATOR WINDING) AND THE FRAME.

Connecting to a Building's Electrical System

Connections for standby power to a building's electrical system must be made by a qualified electrician. The connection must isolate the generator power from utility power or other alternative power sources and must comply with all applicable laws and electrical codes.

WARNING



Generator voltage could cause electrical shock or burn resulting in death or serious injury.

- Use approved transfer equipment to prevent backfeed by isolating generator from electric utility workers.
- When using generator for backup power, notify utility company.
- Use a ground fault circuit interrupter (GFCI) in any damp or highly conductive area, such as metal decking or steel work.
- DO NOT touch bare wires or receptacles.
- DO NOT use generator with electrical cords which are worn, frayed, bare or otherwise damaged.
- DO NOT operate generator in the rain or wet weather.
- DO NOT handle generator or electrical cords while standing in water, while barefoot, or while hands or feet are wet.
- DO NOT allow unqualified persons or children to operate or service generator.

5. OPERATION

Generator Location

WARNING

Make sure you review each warning in order to prevent fire hazard.

- Keep area clear of inflammables or other hazardous materials.
- Select a site that is dry, well ventilated and protected from the weather.
- Keep exhaust pipe clear of foreign objects.
- Keep generator away from open flame.
- Keep generator on a stable and level surface.

CAUTION

Tilting can cause fuel spillage.

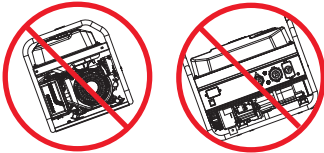

- Do not block generator air vents with paper or other material.

DANGER

Using a generator indoors **CAN KILL YOU IN MINUTES.**

Generator exhaust contains carbon monoxide. This is a poison you cannot see or smell.



NEVER use inside a home or garage, **EVEN IF** doors and windows are open.



Only use OUTSIDE and far away from windows, doors, and vents.

Avoid other generator hazards.
READ MANUAL BEFORE USE.

WARNING

POISONOUS GAS HAZARD.



Engine exhaust contains carbon monoxide, a poisonous gas that could kill you in minutes. You **CANNOT** smell it, see it, or taste it. Even if you do not smell exhaust fumes, you could still be exposed to carbon monoxide gas.

- Operate this product **ONLY** outside far away from windows, doors and vents to reduce the risk of carbon monoxide gas from accumulating and potentially being drawn towards occupied spaces.
- Install battery-operated carbon monoxide alarms or plug-in carbon monoxide alarms with battery back-up according to the manufacturer's instructions. Smoke alarms cannot detect carbon monoxide gas.
- **DO NOT** run this product inside homes, garages, basements, crawlspaces, sheds, or other partially-enclosed spaces even if using fans or opening doors and windows for ventilation. Carbon monoxide can quickly build up in these spaces and can linger for hours, even after this product has shut off.
- **ALWAYS** place this product downwind and point the engine exhaust away from occupied spaces. If you start to feel sick, dizzy, or weak while using this product, shut it off and get to fresh air **RIGHT AWAY**. See a doctor. You may have carbon monoxide poisoning.

Surge Protection

CAUTION

Voltage fluctuation may impair the proper functioning of sensitive electronic equipment.

Electronic devices, including computers and many programmable appliances use components that are designed to operate within a narrow voltage range and may be affected by momentary voltage fluctuations. While there is no way to prevent voltage fluctuations, you can take steps to protect sensitive electronic equipment.

Install UL1449, CSA-listed, plug-in surge suppressors on the outlets feeding your sensitive equipment. Surge suppressors come in single- or multi-outlet styles. They're designed to protect against virtually all short-duration voltage fluctuations.

Starting the Generator (Recoil Start)

1. Before starting the generator, check for loose or missing parts and for any damage which may have occurred during shipment.
2. Check oil level and fuel.

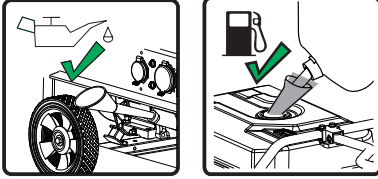

3. Disconnect all electrical loads from the generator. Never start or stop the generator with electrical devices plugged in or turned on.

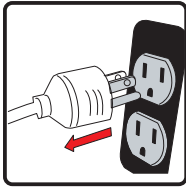

4. Turn the fuel valve to the "ON" (I) position.

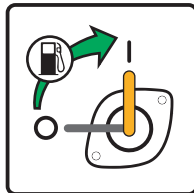

5. Flip the engine switch to the "ON (I)" position.

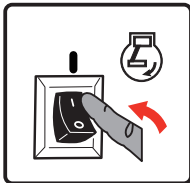

NG2500
NG3500

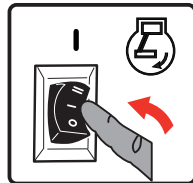

NG3500E2
NG8500E2
NG9500E2

6. Move the choke lever to the "START" position.

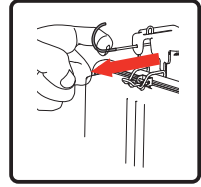
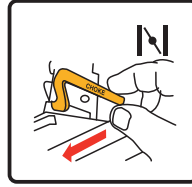

7. Pull the starter cord slowly until resistance is felt and then pull rapidly.

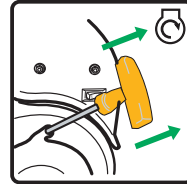

8. Do not over-choke. As soon as engine starts and warms up, move the choke lever to the "RUN" position.

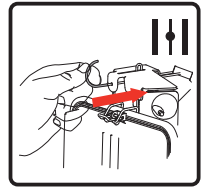
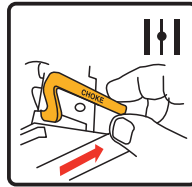

9. Allow generator to run at no load for few minutes upon each initial start-up to permit engine and generator to stabilize.

WARNING



Starter cord kickback (rapid retraction) will pull hand and arm toward engine faster than you can let go which could cause broken bones, fractures, bruises, or sprains resulting in serious injury.

When starting engine, pull cord slowly until resistance is felt and then pull rapidly to avoid kickback.

NOTE:

Keep choke lever in "START" position for only 1 pull of the recoil starter. After first pull, move choke lever to the "RUN" position for up to the next 3 pulls of the recoil starter. Too much choke leads to sparkplug fouling/engine flooding due to the lack of incoming air. This will cause the engine not to start.

NOTE:

If engine starts after 3 pulls but fails to run, or if unit shuts down during operation, make sure unit is on a level surface and check for proper oil level in crankcase. This unit may be equipped with a low oil protection device. If so, oil must be at proper level for engine to start.

Starting the Generator (Electric Start)

⚠ WARNING

Storage batteries give off EXPLOSIVE hydrogen gas while charging. Do not allow smoking, open flames, sparks, or spark producing equipment in the area while charging.

⚠ WARNING

Battery electrolyte fluid is comprised of sulfuric acid that can be very dangerous and cause severe burns. Do not allow this fluid to contact eyes, skin, clothing, etc. If contact or spillage does occur, flush the area with water immediately.

1. Before starting the generator, check for loose or missing parts and for any damage which may have occurred during shipment.
2. Check oil level and fuel.

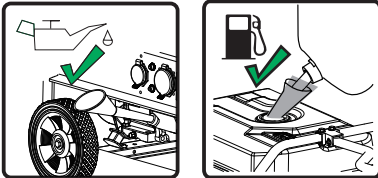

3. Disconnect all electrical loads from the generator. Never start or stop the generator with electrical devices plugged in or turned on.

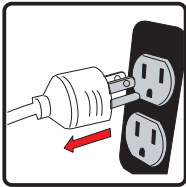

4. Turn the fuel valve to the "ON" (I) position.

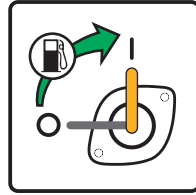

5. Flip the engine switch to the "RUN" (I) position.

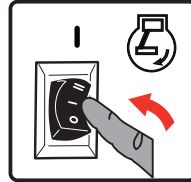

7. Move the choke lever to the "START" position.

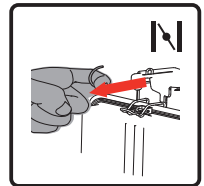
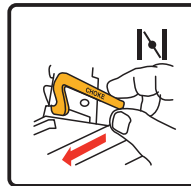

8. Press and hold the engine switch in the "START" (II) position for few seconds and release the switch to the "RUN" (I) position.



9. Do not over-choke. As soon as engine starts and warms up, move the choke lever to the "RUN" position.

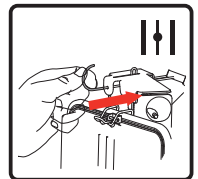

10. Allow generator to run at no load for few minutes upon each initial start-up to permit engine and generator to stabilize.

DO NOT stop engine by moving choke control to "START" position.

Important: Always ensure that the Fuel Valve and the Engine Switch are in the "OFF" position when the engine is not in use.

NOTE:

If the engine will not be used for a period of two weeks or longer, please see the Storage section for proper engine and fuel storage.

Connecting Electrical Loads

This unit has been pretested and adjusted to handle its full capacity. Before starting the generator, disconnect all load. Apply load only after generator is running. Voltage is regulated via the engine speed adjusted at the factory for correct output. Readjusting will void warranty.

⚠ CAUTION

When applying a load, do not exceed the maximum wattage rating of the generator when using one or more receptacles. Also, do not exceed the amperage rating of any one receptacle.

Do not apply heavy electrical load during break-in period (the first five hours of operations).

1. Let engine stabilize and warm up for a few minutes after starting.
2. Ensure circuit breaker on control panel is in on position.
3. Plug in and turn on the desired 230 Volt AC, single phase, 50Hz electrical loads. It is better to attach the item with largest load first.

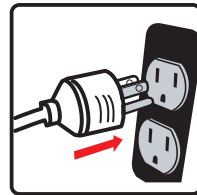

NOTE:

Connecting a generator to your electric utility company's power lines or to another power source may be against the law. In addition this action, if done incorrectly, could damage your generator and appliances and could cause serious injury or even death to you or a utility worker who may be working on nearby power lines. If you plan to run a portable electric generator during an outage, please notify your electric utility company immediately and remember to plug your appliances directly into the generator. Do not plug the generator into any electric outlet in your home. Doing so could create a connection to the utility company power lines. You are responsible for ensuring that your generator's electricity does not feed back into the electric utility power lines. If the generator will be connected to a building

electrical system, consult your local utility company or a qualified electrician. Connections must isolate generator power from utility power and must comply with all applicable laws and codes.

Stopping the Engine

1. Turn off and remove entire electrical loads. Never start or stop the generator with electrical devices plugged in or turned on.

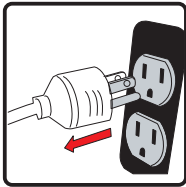

Let the generator run at no-load for two minutes to stabilize internal temperatures of the engine and generator.

2. Flip the engine switch to "OFF" (O) position.

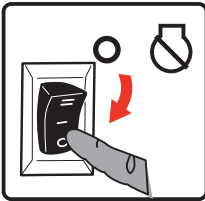

3. Turn the fuel valve to the "OFF" (O) position.

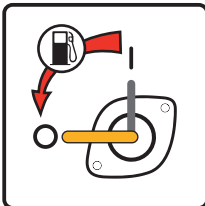

If a cover is used, do not install until unit has cooled.

WARNING



Fuel and its vapors are extremely flammable and explosive which could cause burns, fire or explosion resulting in death, serious injury and/or property damage.

Low Oil Shutdown

If the engine oil drops below a preset level, an oil switch will stop the engine. Check oil level with dipstick.

If oil level is between LOW and HIGH mark on dipstick:

1. DO NOT try to restart the engine.
2. Contact an Authorized Service Dealer.
3. DO NOT operate engine until oil level is corrected.

If oil level is below LOW mark on dipstick:

1. Add oil to bring level to HIGH mark.
2. Restart engine and if the engine stops again a low oil condition may still exist. DO NOT try to restart the engine.
3. Contact an Authorized Service Dealer.
4. DO NOT operate engine until oil level is corrected.

Do Not Overload Generator

Overloading a generator in excess of its rated wattage capacity can result in damage to the generator and to connected electrical devices.

To prolong the life of your generator and attached devices, follow these steps to add electrical load:

1. Start the generator with no electrical load attached.
2. Allow the engine to run for several minutes to stabilize.
3. Plug in and turn on the first item. It is best to attach the item with the largest load first.
4. Allow the engine to stabilize.
5. Plug in and turn on the next item.
6. Allow the engine to stabilize.
7. Repeat steps 5-6 for each additional item.

MAINTENANCE AND STORAGE

MAINTENANCE SCHEDULE

ITEM	NOTES	Daily(Before operation)	Initial 25 hours	Every 50 hours	Every 100 hours (or annual)
Spark Plug	Check condition. Adjust gap and clean. Replace if necessary.				✓
Engine Oil	Check oil level.	✓			
	Replace.		✓		✓
Air Filter	Clean, replace if necessary.			✓	
Fuel Filter	Clean fuel filter and fuel tank strainer. Replace if necessary.				✓
Fuel Line	Check fuel hose for cracks or other damage. Replace if necessary.	✓			
Exhaust System	Check for leakage. Retighten or replace gasket if necessary.	✓			
	Check spark arrester screen. Clean/Replace if necessary.				✓
Carburetor	Check choke operation.	✓			
Starting System	Check recoil starter operation.	✓			
Fittings/ Fasteners	Check. Replace if necessary.				✓

General Recommendations

Regular maintenance will improve the performance and extend the life of the generator. See any authorized dealer for service.

The generator's warranty does not cover items that have been subjected to operator abuse or negligence. To receive full value from the warranty, the operator must maintain the generator as instructed in this manual.

Some adjustments will need to be made periodically to properly maintain your generator.

All service and adjustments should be made at least once each season. Follow the requirements in the Maintenance Schedule chart above.

Notice Once a year you should clean or replace the spark plug and replace the air filter. New spark plugs and clean air filter assure proper fuel-air mixture and help your engine run better and last longer.

ENGINE MAINTENANCE

To prevent accidental starting, remove and ground spark plug wire before performing any service.

Change Engine Oil

Change engine oil every 100 hours.
(for a new engine, change oil after 25 hours.)

If you are using your generator under extremely dirty or dusty conditions, or in extremely hot weather, change the oil more often.

CAUTION

Avoid prolonged or repeated skin contact with used motor oil.

- Used motor oil has been shown to cause skin cancer in certain laboratory animals.
 - Thoroughly wash exposed areas with soap and water.
- (a) Drain oil by removing the drain plug and the oil filler cap while the engine is warm.

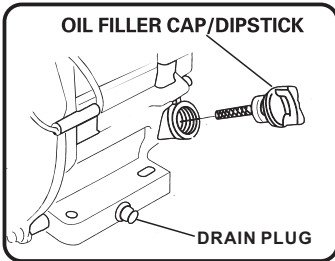

NOTE:

Please use a container to dump the used oil for protecting the environment.

(b) Reinstall the drain plug and fill the engine with oil until it reaches the HIGH(H) level on the oil filler cap.

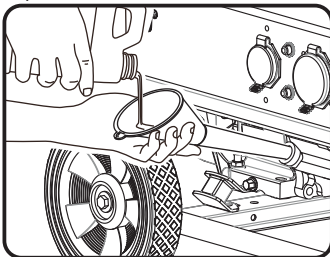

- Use fresh and high quality lubricating oil to the specified quantity.
If contaminated or deteriorated oil is used or the quantity of the engine oil is not sufficient, the engine damage will result and its life will be greatly shortened.

Air Filter Maintenance

Maintaining an air filter in proper condition is very important. Dirt induced through improperly installed, improperly serviced, or inadequate elements damages and wears out engines. Always keep the element clean.

(a) Take out the air cleaner, clean it well in kerosene and dry it.

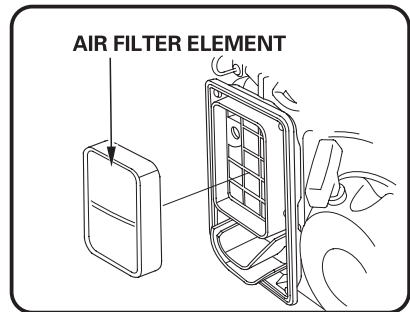
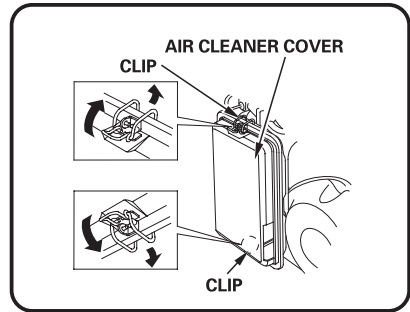

(b) After wetting the element by clean engine oil squeeze it tight by hand.

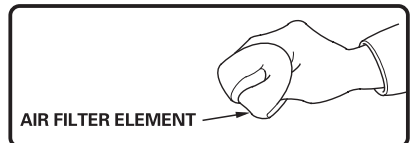

(c) Lastly, put the element in the case and install it securely.

Spark Plug Maintenance

Changing the spark plug will help your engine to start easier and run better.

- Remove the spark plug cap.
- Remove spark plug using provided wrench.

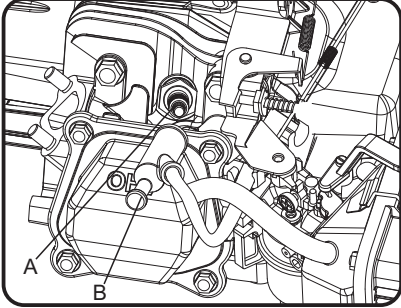

A- Spark plug
B- Spark plug cap

- Inspect spark plug for damage and clean with a wire brush before reinstalling
- Adjust the electrode gap to 0.7 to 0.8 mm (0.028" to 0.031").
- Seat spark plug in position and thread by hand to prevent cross threading.
- Tighten plug with provided wrench and put the cap back on spark plug.

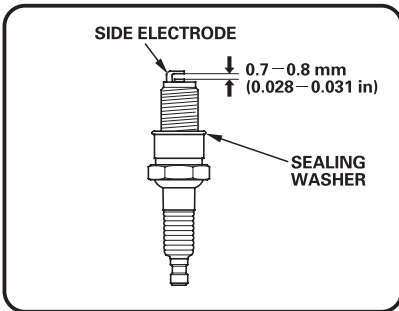

SPARK PLUG: TORCH F6RTC
NGK BPR6ES
CHAMPION RN9YC equivalent.

Cleaning Fuel Strainer

Dirt and water in the fuel are removed by the fuel strainer.

- Remove the strainer cup and throw away water and dirt.
- Clean the screen and strainer cup with gasoline.
- Tightly fasten the cup to main body, making sure to avoid fuel leak.

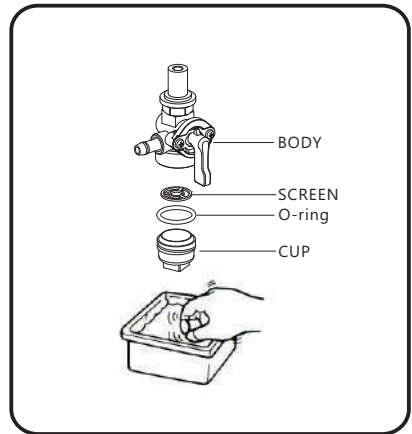

Inspect Muffler

Inspect the muffler for cracks, corrosion, or other damage. Remove the spark arrester, if equipped, and inspect for damage or carbon blockage. If replacement parts are required, make sure to use only original equipment replacement parts.

⚠ WARNING



Exhaust heat/gases could ignite combustibles, structures or damage fuel tank causing a fire, resulting in death or serious injury and/or property. Contact with muffler area could cause burns resulting in serious injury.

- **DO NOT** touch hot parts and **AVOID** hot exhaust gases.
- Allow equipment to cool before touching.
- Keep at least 5 feet (1.5 m) of clearance on all sides of generator including overhead.
- Replacement parts must be the same and installed in the same position as the original parts.

GENERATOR MAINTENANCE

Make certain that the generator is kept clean and stored properly. Only operate the unit on a flat, level surface in a clean, dry operating environment. **DO NOT** expose the unit to extreme conditions, excessive dust, dirt, moisture or corrosive vapours.

CAUTION

DO NOT use a garden hose to clean the generator. Water can enter the generator through the cooling slots and damage the generator windings.

Use a damp cloth to clean exterior surfaces of the generator.

Use a soft bristle brush to remove dirt and oil. Use an air compressor (25 PSI) to clear dirt and debris from the generator.

Inspect all air vents and cooling slots to ensure that they are clean and unobstructed.

Battery Replacement

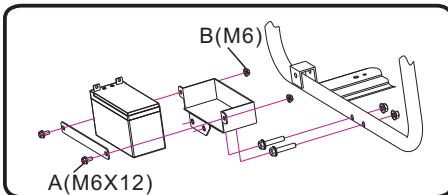

1. Remove the spark plug wire from spark plug.
2. Remove the nut and bolt from the negative(-) and positive(+) posts.
3. Loosen and remove the screw A and nut B on the battery holding bracket.
4. Remove the battery and recycle and dispose of properly.
5. Install the new battery with following specification:
12V sealed lead acid 7.5AH
LXWXH:151X65X97mm(5.95X2.55X3.82inch)

6. Connect the red positive(+) battery cable to the battery first.
7. Connect the black positive(-) battery cable to the battery second.
8. Cover the post with boots.
9. Install the spark plug wire onto spark plug.

WARNING



To avoid electric shock:

ALWAYS connect the positive (+) battery cable (red boot) first when connecting battery cables.

ALWAYS disconnect the negative (-) battery cable (black boot) first when disconnecting battery cables.

NEVER connect the negative (-) battery cable (black boot) to the positive (+) post on the battery.

NEVER connect the positive (+) battery cable (red boot) to the negative (-) post on the battery.

NEVER touch both battery posts simultaneously.

NEVER place a metal tool across both battery posts.

ALWAYS use insulated or nonconducting tools when installing the battery.

SERVICE AND STORAGE

Infrequent Service

If the unit is used infrequently, difficult starting may result. To eliminate hard starting, follow these instructions:

1. Run the generator at least 30 minutes every month.
2. Run the generator, then close the fuel shut-off valve and allow the unit to run until the engine stops.
3. Move the fuel selector to the "OFF" position.

Long Term Storage

It is important to prevent gum deposits from forming in essential fuel system parts such as the carburetor, fuel hoses or tank during storage. Also, experience indicates that alcohol-blended fuels (called gasohol, ethanol or methanol) can attract moisture, which leads to separation and formation of acids during storage. Acidic gas can damage the fuel system of an engine while in storage.

When the generator set is not being operated, or is being stored for more than one month, follow these instructions to avoid engine problems:

- 1-**ADD** a properly formulated commercially **FUEL STABILIZER** to the tank if it is not already added.
- 2-Operate the engine for 5-10 minutes to circulate treated fuel into fuel lines and carburetor before shutdown.
- 3- After engine cools down, remove all gasoline from the fuel tank. Use a commercially available, non-conductive vacuum siphon.

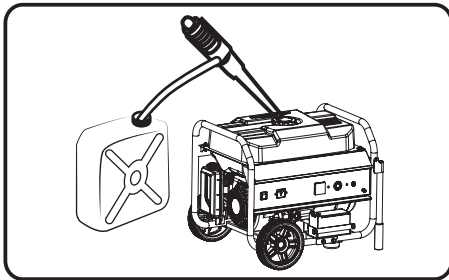

⚠ DANGER

Drain fuel into approved container outdoors, away from open flame. Be sure engine is cool. Do not smoke.

- 4-**FUEL STARVATION:** Turn fuel selector switch to "GAS" position. Start and run the generator until it stops from lack of gasoline. This will dry out all remaining gasoline in tank, fuel lines and carburetor.
- 5-Turn fuel selector switch to "OFF" position. Fully close the LPG cylinder knob if it is open and disconnect LPG cylinder from the generator.
- 6-Allow the unit to cool entirely before cleaning and storage.
- 7-Change oil with recommended grade oil.
- 8-Remove spark plug and pour about one teaspoon of engine oil through the spark plug hole, then pull the recoil starter several times to distribute the oil for lubricating the cylinder. Reattach the spark plug. Pull recoil slowly until resistance is felt. This will close the valves so moisture cannot enter engine cylinder. Gently release recoil starter.
- 9-Cover the unit and store in a clean, dry place out of direct sunlight. **NEVER USE WATER TO CLEAN GENERATOR.**

NOTE:

- We recommend always using a fuel stabilizer. A **FUEL STABILIZER** will minimize the formulation of fuel gum deposits during storage, the fuel stabilizer can be added to the gasoline in the fuel tank, or into the gasoline in a storage container.
- If it is not practical to empty the fuel tank and the unit is to be stored for some time, use a commercially available **FUEL STABILIZER** added to the gasoline to increase the life of the gasoline. Run the unit for 5-10 minutes to circulate treated gasoline into the fuel lines and carburetor before shutdown. **DO NOT STORE GENERATOR WITHOUT FUEL STABILIZER IN FUEL SYSTEM INCLUDING TANK, FUEL LINES AND CARBURETOR.**
- Any damages or hazards caused by using improper fuel, improperly stored fuel, and/or improperly formulated stabilizers, are not covered by manufacturer's warranty.
- Do not store gasoline from one season to another season.

TROUBLE SHOOTING

Problem	Cause	Correction
Engine is running, but no AC output is available.	<ol style="list-style-type: none"> 1. Circuit breaker is open. 2. Fault in generator. 3. Poor connection or defective cord set. 4. Connected device is bad. 	<ol style="list-style-type: none"> 1. Reset circuit breaker. 2. Contact authorized service facility. 3. Check and repair. 4. Connect another device that is in good condition.
Engine runs good at no-load but "bogs down" when loads are connected.	<ol style="list-style-type: none"> 1. Short circuit in a connected load. 2. Engine speed is too slow. 3. Generator is overloaded. 4. Shorted generator circuit. 5. Clogged or dirty fuel filter. 	<ol style="list-style-type: none"> 1. Disconnect shorted electrical load. 2. Contact authorized service facility. 3. See Don't Overload Generator 4. Contact authorized service facility. 5. Clean or replace fuel filter.
Engine will not start; starts and runs rough or shuts down when running.	<ol style="list-style-type: none"> 1. Engine switch set to OFF (O) position. 2. Fuel shutoff lever is in OFF (O) position. 3. Low oil level. 4. Dirty air cleaner. 5. Out of fuel. 6. Stale fuel. 7. Spark plug wire not connected to spark plug. 8. Bad spark plug. 9. Water in fuel. 10. Flooded. 11. Excessively rich fuel mixture. 12. Intake valve stuck open or closed. 13. Engine has lost compression. 14. Clogged or dirty fuel filter. 15. Starting battery may have in sufficient charge. 	<ol style="list-style-type: none"> 1. Set engine switch to ON (I) position. 2. Move fuel shutoff lever to ON (I) position. 3. Fill crankcase to proper level or place generator on level surface. 4. Clean or replace air cleaner. 5. Fill fuel tank. 6. Drain fuel tank and carburetor; fill with fresh fuel. 7. Connect wire to spark plug. 8. Replace spark plug. 9. Drain gas tank and carburetor; fill with fresh fuel. 10. Wait 5 minutes and re-crank engine. 11. Contact authorized service facility. 12. Contact authorized service facility. 13. Contact authorized service facility. 14. Clean or replace fuel filter. 15. Check battery output and charge battery as necessary.
Engine lacks power.	<ol style="list-style-type: none"> 1. Load is too high. 2. Dirty air filter. 3. Clogged or dirty fuel filter. 4. Clogged spark arrester. 	<ol style="list-style-type: none"> 1. Don't Overload Generator 2. Replace air filter. 3. Clean or replace fuel filter. 4. Clean or replace spark arrester.
Engine "hunts" or falters.	<ol style="list-style-type: none"> 1. Carburetor is running too rich or too lean. 2. Clogged or dirty fuel filter. 	<ol style="list-style-type: none"> 1. Contact authorized service facility. 2. Clean or replace fuel filter.
Engine shuts down when running.	<ol style="list-style-type: none"> 1. Out of fuel. 2. Dirty air cleaner. 3. Low oil level. 	<ol style="list-style-type: none"> 1. Fill fuel tank. 2. Clean or replace air cleaner. 3. Fill crankcase to proper level or place generator on level surface.

All rights reserved. Any reprinting or unauthorized use without
the written permission is expressly prohibited.
P/N:323745451 Rev 01