

User Manual for Electric Scooter



Read Me First

Dear user,

Thanks for purchasing this electric scooter. This electric scooter is an environmentally-friendly high-tech product as well as an ideal means of transport that features excellent shock absorption, streamlined appearance, portability and flexibility, good riding comfortability, high safety and reliability. For better understanding of the characteristics, technical parameters, correct use and maintenance, precautions and safe-sale services of this scooter, see to it that you read this user manual carefully before using it.

1. DO NOT use the scooter before learning about its performance.
2. DO NOT lend your scooter to anyone who cannot operate it, juveniles, pregnant women, or the disabled.
3. DO NOT arbitrarily discard spent batteries to avoid pollution to the environment; see to it that they are handled by your distributor or service provider.
4. For sake of your own safety, please check whether the braking system functions well before using the scooter.
5. For safety reasons, DO NOT cover the charger and keep it well ventilated during charging.
6. When replacing a failed tire, note that the fasteners of the wheel are tightened in case of a secondary accident due to wheel looseness.
7. For safe use of this product, DO NOT arbitrarily disassemble or modify the circuit or parts of the scooter.
8. In case of any abnormality, power the scooter off to stop it in order to ensure your safety.
9. Images included in this user manual are intended for operation demonstration and may not be used for the basis of product inspection.
10. In the event that images included in this user manual might not be in conformity with the real product, the real product shall prevail.
11. Product performance and configuration that may be improved from time to time are subject to change without prior notice.

Enjoy your riding!

Content

1.Read Me First	
2.Content -----	01
3.Check the Items -----	02
4.Structural Diagram -----	03
5.Improper Use Cases -----	04~05
6.Legal Statement -----	06~08
7.Dashboard Instructions -----	09
8.Parameters -----	10
9.How to Use and Pre cautions -----	10~12
10.Troubleshooting -----	13
11.Overall Diagram -----	14
12.After-sale Services -----	15
13.Warranty Card -----	16

Check the Items



Electric scooter	1	User manual & warranty card	1
Charger	1		

Structural Diagram



① Handle

② Brake handle

③ Main tube

④ Folding mechanism

⑤ Front fender

⑥ Rear fender

⑦ Rear drive motor

⑧ Disc brake

⑨ Rear damper

Improper Use Cases

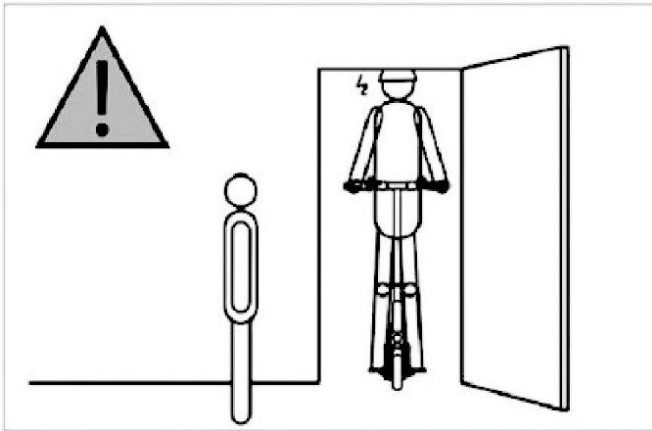

Watch out for overhead obstacles, such as the door frame or the elevator.



DO NOT pass irregular surfaces at a high speed.

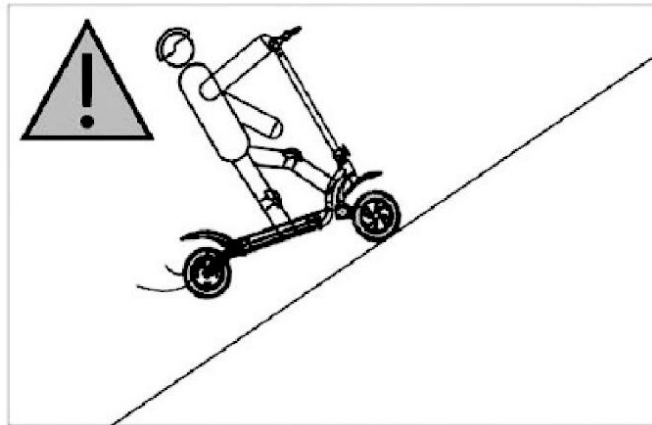

DO NOT ride on slopes larger than 20° for extended periods of time.

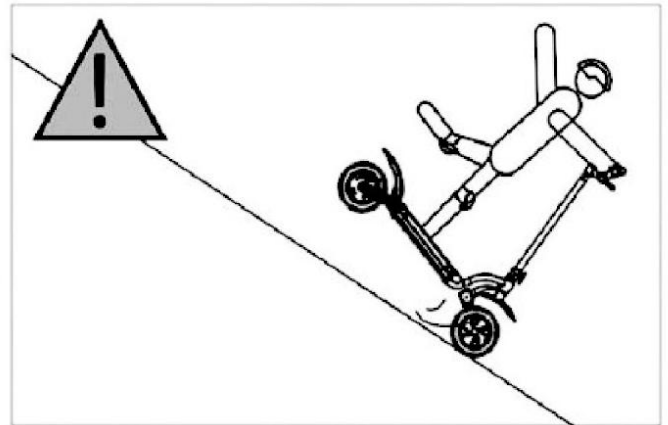

DO NOT accelerate while riding downhill. DO NOT use the front brake while riding at a high speed.

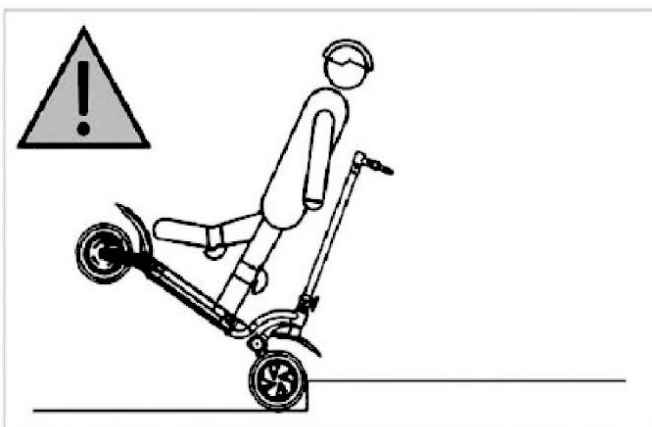

DO NOT go up/down steps or cross obstacles with the scooter.

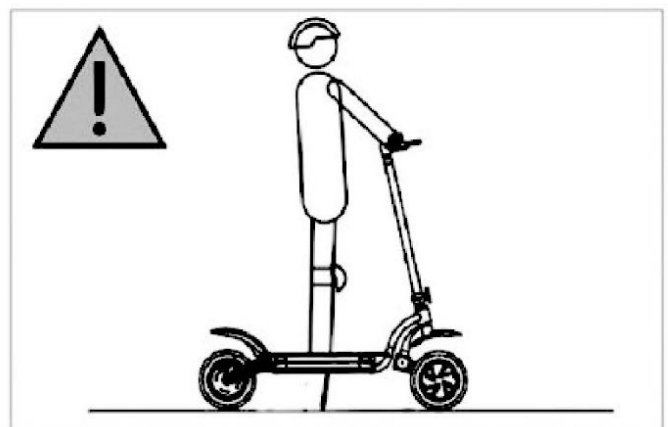

DO NOT stand on the footboard after the scooter is powered off and stops.



DO NOT ride in the rain

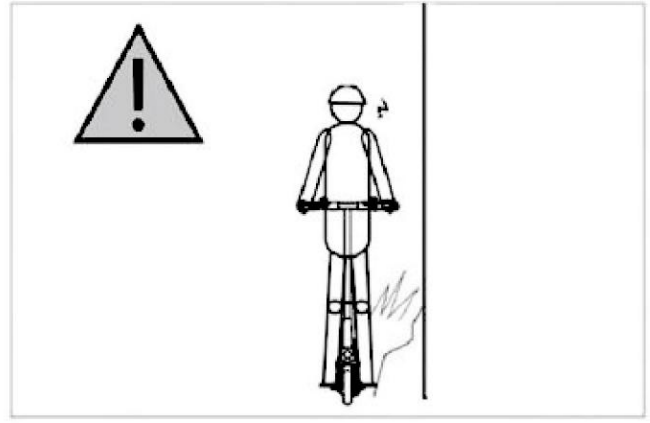

Avoid obstacles while riding

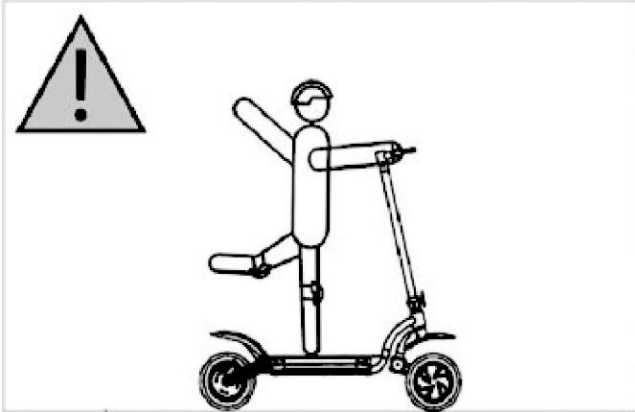

DO NOT ride with a single hand or foot

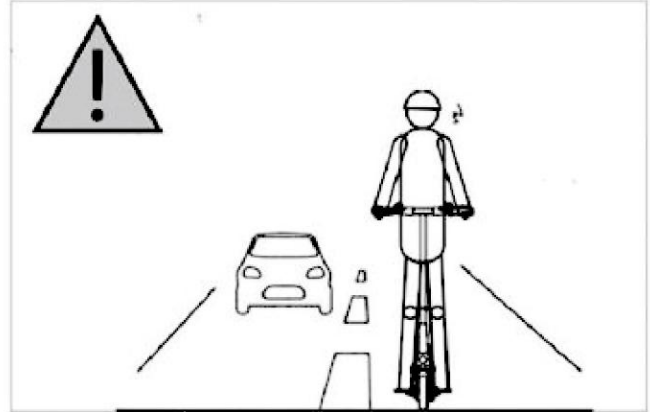

DO NOT ride on motor way

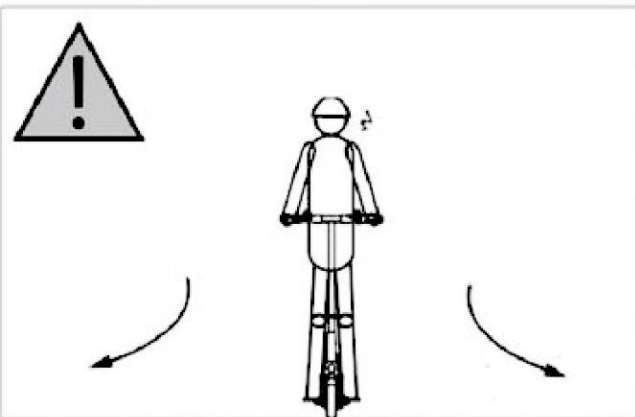

DO NOT rotate the handle violently while riding at a high speed

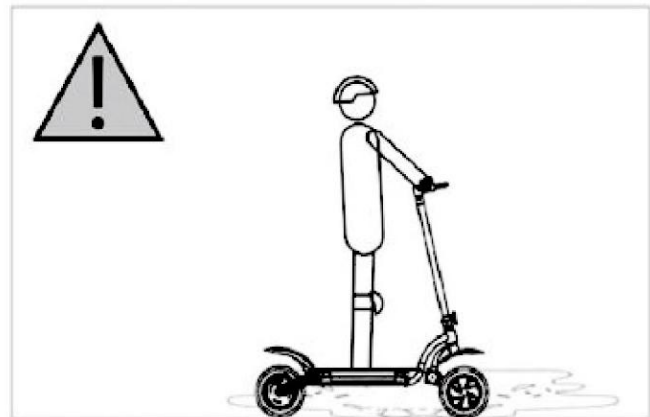

DO NOT ride in water deeper than 2cm

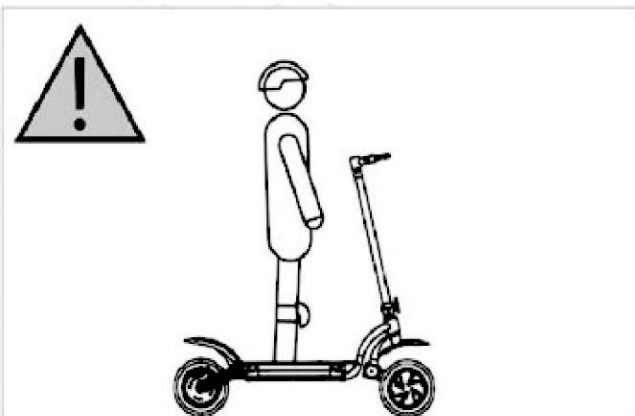

DO NOT ride with both hands leaving the handle

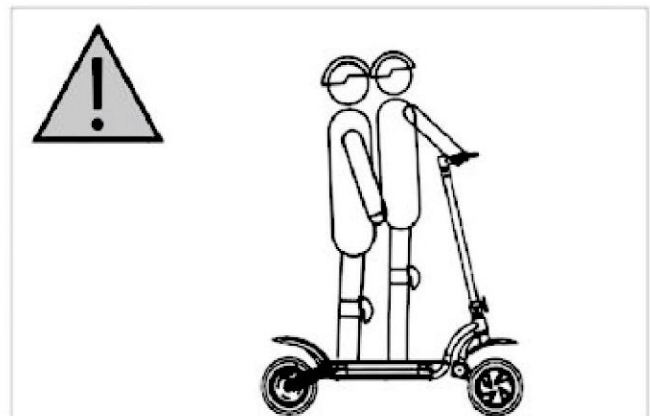

DO NOT carry passenger(s)

Legal Statement

As you have been acquainted with this scooter with more riding skills, please:

1. Read this user manual carefully before using it for practice.
2. Those who haven't read this user manual carefully in advance are not allowed to use this scooter.
3. Install all the parts of this scooter properly following this user manual, otherwise improper installation may lead to control failure, collision or crash. Turn the power off before installation, repair or maintenance. Install the parts appropriately, neither too loose nor too tight, otherwise it might cause damage or failure.
4. DO NOT charge when the slot/socket is wet. Charge the scooter with correct power supply (200~240V/50-60Hz). While charging, keep children, pet or inflammables away from the scooter.
5. DO NOT place the battery unit in the environment where temperature is higher than 50°C or lower than -20°C.
6. In the event that the battery unit is damaged or hot, smells abnormally, or smokes, stop using it immediately and keep it away from other objects.
7. DO NOT open or disassemble the battery unit that contains harmful substance.
8. The scooter that has been fully charged may stand by for 120-180 days, whereas the one that is undercharged may stand by 30-60 days. Please notice the stand-by time of your scooter in case of unrecoverable damages to the battery unit due to untimely charging.
9. It is prohibited that you practice outdoor until you have been sufficiently familiar with the operation methods of the scooter. The more times you practice, the safer you can ride in new circumstances. Please note the essentials of practice: what you need first is primary practice in an obstacle-free area (e10m×10m) to practice riding forward, making turns and stopping. Keep yourself relaxed while practicing. When you practice for the first time, it is recommended that you do this with the guidance of an experienced person or coach. Try to practice passing narrow areas, turning and stopping as your practice deepens. You are not allowed to ride on normal roads until you are able to control your scooter to pass a narrow area precisely and have simulated all types of terrains. You may have a different riding experience every time you have your electric scooter upgraded. Therefore, see to it that you practice in the same obstacle-free area as if you were a beginner for the first time you ride the scooter after upgrading.
10. Check the scooter carefully to make sure there isn't any loose part or damage before riding it.
11. Watch the crossing carefully before or during you ride your scooter or when you stop it to avoid any unnecessary damages to yourself, or objects, people or small animals around you.
12. Maintain tire pressure at the level described in the parameters. Excessive tire pressure may increase the risk of control failure, collision or crash, whereas insufficient tire pressure may result in wheel damage.
13. Check tire pressure at least twice a month and before you ride for a long distance, otherwise incorrect tire pressure can cause instability or wheel damage, even an accident.
14. In the event that the tire works abnormally during riding, please stop and examine it in case of danger.
15. Get on the scooter from either side and wear dedicated protective equipment.
16. DO NOT ride in high-heeled shoes.
17. DO NOT dip the battery and scooter frame into water, expose it to storms or ride in the rain for a long time. DO NOT clean the scooter with powerful water stream or a high-pressure water gun to avoid waterlog in the charging port. In the event that your scooter is exposed to storms for a long time, please stop using it immediately, wipe it with a piece of dry soft cloth,

and contact after-sale service personnel. DO NOT do anything other than wiping the scooter in case of voided warranty due to any misconduct.

18. Scooter's braking performance (including other vehicles on the same road) can significantly degrade along with tire friction in rainy days, which makes it more difficult to control and thus lead to control failure. To ensure safe riding during rainy days, please ride at a lower speed than usual and brake in advance.
19. In the event of low battery, the scooter may not run at a high speed continuously as expected. You may charge it for better riding experience.
20. With good usability of this scooter, you may be too confident to decelerate when passing obstacles, uneven or slippery surfaces, soft ground or abrupt slopes at a high speed. You may collide, fall off or get injured due to control failure under such circumstances. Please ride with caution in complex road conditions.
21. Note terrain changes while riding, such as road and grassplot.
22. Be careful while turning! You may lose control at fast turning.
23. DO NOT risk passing the abrupt slope, uneven surface or other unfamiliar terrains.
24. DO NOT ride on the motor way or run a red light. Follow traffic rules and give way to pedestrians.
25. Please respect the rights of the others who share the road or path with you, including motor cyclists, cyclists, pedestrians and other riders.
26. Strengthen your awareness of self-protection while riding. Watch out for yourself, vehicles and pedestrians.
27. Be ready to respond to the following situations while riding: an vehicle decelerates or makes a turn when it crosses the crossing in front of you or approaches from behind; a vehicle with door(s) left open; a pedestrian walks near from the sidewalk; there are children or a pet playing by the road; holes, manhole covers, rails, expansion joints, road/sidewalk construction, debris, and other obstacles; other situations that may disperse your attention. In those situations, the wheel can make involuntary turning or catch on something, or some other accident can occur.
28. Please ride on the bikeway or at the edge of road along the direction of traffic flow or the direction specified by the regulations of local government.
29. Stop the scooter slowly at the parking sign or by the traffic light and observe the conditions in the crossing. Bear in mind that you make a way for motor vehicles even though you are riding on the bikeway to avoid the risk of collision.
30. It is absolutely prohibited that you are towed by another vehicle with hand(s) on the vehicle while riding.
31. DO NOT stunt while riding.
32. DO NOT ride your scooter in any of the following situations: severe weather, poor visibility, at dawn, in the evening, in the dark, or exhaustion since an accident is more likely to occur in event of any of these situations.
33. DO NOT ride your scooter to a remote area alone. Please inform others of your destination and expected time of arrival even if you ride to the remote area with someone else.
34. As you are higher while standing and riding helmeted on the scooter, watch out while you are riding indoor, at the door or near any other place that is close to your head.
35. DO NOT wear loose clothes while riding in case they are entangled into the wheel.
36. It is recommended you wear goggles to keep your eyes away from contaminants, dust and insects. Please wear goggles with darker glasses in strong light and more transparent glasses in poor light.
37. DO NOT carry a passenger while riding. This scooter is designed for a single rider. It is prohibited that it is ridden by two or by anyone carrying a baby.

38. This scooter cannot be used as a medical equipment or an auxiliary medical means. As a result, it is required that you are physically qualified to operate this scooter alone without the assistance from anybody else.
39. DO NOT use your scooter to go upstairs/downstairs, ride it into the elevator or cross the revolving door.
40. DO NOT ride in poor visibility. Make sure you and others are mutually visible before riding.
41. DO NOT ride on the highway unless it is allowed by local laws and regulations.
42. DO NOT use your scooter as a cargo carrier.
43. When approaching or crossing an intersection, motor way, turning or passing by a door/gate, please slow down and give way to the pedestrians, bicycles and motor vehicles.
44. Similar to other means of transport, you need to stay vigilant while riding your scooter. DO NOT ride your scooter when you fall ill or cannot fully comply with the instructions specified in this user manual, or after you take medicine or drink alcohol.
45. To avoid distraction while riding, DO NOT make phone calls or do anything that might distract you so that you are able to concentrate yourself on traffic.
46. Age requirement:16-50 years old. Tips for parents: as a parent or a guardian, you are responsible for your child's activities and safety. It is highly recommended that your child is kept away from the scooter.
47. Avoid abrupt braking, especially on smooth surfaces since this may lead to loss of traction and increase the possibility of you falling off from the scooter.
48. The scooter can tip to one side if you park it without using the stand.
49. If you use your scooter in summer, note that keep your scooter in a safe place where temperature is not higher than 45 °C ;DO NOT park your scooter outdoor in sunshine for a long time.
50. If you use your scooter in winter, note that keep your scooter in a safe place where temperature is not lower than -20 °C ; keep your scooter at room temperature for at least half an hour before charging it when ambient temperature is lower than 0 °C.
51. Any modification to this scooter may undermine your safety of riding. Any unauthorized modification to this scooter is prohibited.
52. You are obliged to be informed of and observe the laws of the place where you are located.
53. We do not warrant the safety if you use any non-original part or accessory for your scooter even if it has been approved by responsible governmental agencies, nor do our warranty services apply to this case. Please contact our after-sale service department for any problem, which is also the most guaranteed option you can resort to.
54. Scooter data and parameters that vary in different models are subject to change without prior notice.

This statement applies to the laws of the People's Republic of China.

We assume no responsibility for any claim, liability or loss incurred by or possibly incurred by consumer's violation of the clauses of the legal statement above. The rider by himself/herself shall undertake the responsibility for any unpredictable or inevitable risk during riding.

You are free to continue to use our product if you accept the clauses set forth in our legal statement or return it if otherwise.

Please make sure the product and its package are as intact as they don't impact resale before returning the product to us.

In the event that you resell your scooter someday, bear in mind that a same copy of legal statement that is deemed as a legal part of this scooter is handed over to its new owner.

If you have any questions or difficulties, we are always at your service.

Dashboard Instructions



Battery level indication

There is a five-bar battery level indicator in the dashboard. Battery level will be indicated by the five bars that are on/off from left to right, respectively. Five bars means battery level lies between 100%-85%, four bars means battery level lies between 85%-70%, and so forth. The bars are off one by one as battery is consumed. When there is only one bar left, it means the battery is exhausting. When the battery completely runs out, all five bars will be off and the scooter will naturally stop after freewheeling for a certain distance.

Gear indication

A five-gear indicator is provided in the dashboard. Shift gear using the upshift/downshift buttons on the right side of dashboard. Three gear indicates the fastest speed and first gear means slowest speed.

Power switch

Power button lies between upshift and downshift buttons. Short press power button to power the scooter on if when the scooter is in the power-off mode; press power button for over 2s to power it off.

Parameters

Specifications	Content	Note
Dead-weight	25kg single-motor/ 30kg double-motor	Standard configuration without package and accessories.
Max speed	55km/h	
Trip distance	40km single-motor, 80km double-motor	Measured when the scooter that is fully charged runs on a flat road at an average speed of 20km/h with a load of 75kg.
Gradient	30°	30° for a rider weighing 60kg
Applicable temperature	-10°C~40°C	Most applicable temperature range is 20°C~30°C
Battery	48V 23Ah	
Max motor power	1200w single-motor 2400w double-motor	
Max load	120KG	
Charge input voltage	AC 110V~220V/50~6Hz	
Charging time	5h single-motor, 10h double-motor	5h for single-motor, 10h for double-motor (fast charge available)
Folding size	120*26*52cm	
Full size	120*26*118cm	
Package size	124*30*65cm	
Footpad clearance	21cm	

How to Use and Precautions

(1) Safe use

1. In the benefit of you and the others, please read this user manual carefully before using the scooter. DO NOT use it until you have adequate knowledge about its performance. DO NOT lend it to whomever is unfamiliar with the operation of this scooter.
2. Please observe traffic rules consciously. Ride your scooter in the non-motor lane. DO NOT carry a passenger.
3. Ride at a proper speed during rainy or snowy days since the scooter can run really fast. If necessary, brake in advance to ensure the scooter stops within an appropriate braking distance;
4. DO NOT ride in waterlogged areas where seep depth exceeds 1/3 of wheel diameter.

(2) Check before use

1. Check whether the wheels rotate well and whether tire pressure is in a normal range.
2. Check whether the battery has been fully charged.
3. Check whether the braking system works flexibly and make sure that the power is cut off when braking.
4. Check whether the folding mechanism has been locked up.

(3) Operations

1. Startup: when the power switch is turned on, the indicator on the dashboard will be on, which means the scooter is powered up. Then check the single/double driving modes, regulate the speed threshold to an appropriate gear, press the speed regulating handle slowly and rotate it to an appropriate position based on speed to keep the scooter running at a safe speed.
2. Avoid frequent braking or startup while riding, which helps prolong the battery's service life. When decelerating, release the speed regulating handle until motor power is cut off. In the event of an emergency that requires emergency braking, hold left/right power-cut brake handles tightly and the power will be cut off along with braking to make sure the scooter stops immediately. Max speed of this scooter is 55km/hour on the flat road. Double-wheel braking system is provided for the double-motor scooter, whereas the single-motor version is only provided with a rear-wheel braking system.
3. When riding at night, turn the front/back LED light on. Turn the electric switch to lock position when parking in order to ensure safety.

(4) Use of Battery and Precautions

1. The battery unit consists of sealed 18650 li-ion batteries that feature long service life and leakage-proof sealed structure. Considering the fact that the battery unit has been in storage for a long time since it is manufactured, please make sure it is fully charged before using the scooter for the first time. Recharge the battery unit timely in the event of low battery during riding. Have the battery unit fully charged before long storage, and charge/discharge once a week if possible.
2. Use the dedicated charger only, otherwise battery's service life might be undermined.
3. Battery indication: observe battery level while riding since the observed result in the stationary state is inaccurate. Charge the scooter timely in the event of low battery indication.
4. DO NOT touch the metal contacts on the charger socket with hand or metal that may cause short-circuit in case of accidents.

(5) Use of Charger and Precautions

1. Plug the charger's output terminal into charging hole on the battery unit, then connect the charger to AC 220V/50HZ power supply and make sure the charging indicator is on. To avoid damages to the controller, power the scooter off during charging time that can last 5-10 hours.
2. Trip distance can decline at a low temperature.
3. Charging mode: it is recommended that the scooter be charged once a day if possible. The whole charging process is automatically controlled: when the charging indicator turns to green, it means the battery unit has been fully charged and is in a floating charge state. Floating charge doesn't cause any damage to batteries. At this point, it is unnecessary to stop charging since very little energy is consumed during floating charge.
4. In case of damages, avoid violent bump or impact when using, shipping or carrying the charger. Keep liquid or metal filings away from the charger in case it is short-circuited or damaged.
5. DO NOT place inflammables under the charger because heat is generated while it is working. It is prohibited that the charger is covered or surrounded by anything so as not to affect heat dissipation. The charger shall be used in a well-ventilated place. In the event that there is peculiar smell, smoke, or excessive temperature (higher than 65 °C) from/on the charger, stop charging immediately and have it repaired in the maintenance department.
6. In the event that the charging indicator doesn't turn green for a long time (generally longer than 10 hours) while the charger is in the charging mode all the time, particularly along with a high battery temperature due to charger failure, battery damage or low voltage, please stop charging immediately and have the scooter repaired in the maintenance department.
7. For sake of adaptability between the charger and battery, please DO NOT charge your scooter using chargers other than the dedicated one.

(6) Use of Motor (s) and Precautions

1. Features: new type of brushless low-speed high-power motor that features high efficiency, low noise, and large mileage at rated load within the normal operating range.
2. Scheduled maintenance: the motor doesn't need any particular maintenance under normal circumstances.
3. When going uphill with a heavy load, restart the scooter in the event of locked rotor to avoid damages to the motor or controller.

(7) Routine Maintenance and Precautions

1. Rotate the speed regulating handle slowly rather than violently.
2. DO NOT wash the scooter directly to avoid short-circuit of electric/electronic parts due to moisture/water.
3. For safety sake, turn the main power switch off when parking the scooter.
4. Change into off-the-road tires when riding in complex road conditions, such as mountain road.
5. Replace for a new brake pad when 1/3 of it has been worn out and braking effect is impacted.
6. Remove the contaminants adhered to brake disc or other surfaces.
7. Check whether or not the electric part of power-cut brake is well connected and whether the fasteners are loose. Make timely adjustment if any.
8. Make periodical examinations and maintenance, generally once every six months.

Troubleshooting

Symptom	Reason	Solution
Speed regulating handle malfunctions or speed decreases	<ol style="list-style-type: none"> 1. Low battery voltage; 2. Loose connection in the speed regulating handle; 3. The spring in the speed regulating handle is stuck or fails. 	<ol style="list-style-type: none"> 1. Have the battery fully charged; 2. Re-plug and clamp the fault part; 3. Replace for a new speed regulating handle.
The dashboard isn't on after power is turned on	<ol style="list-style-type: none"> 1. Poor contact between dashboard and power supply; 2. Dashboard failure or poor contact of plug-in components. 	<ol style="list-style-type: none"> 1. Replace the dashboard or power plug; 2. Replace for a new dashboard.
The scooter cannot run normally after it is powered on	<ol style="list-style-type: none"> 1. Low battery' 2. Speed regulating handle failure; 3. left/right power-cut brake handle malfunction; 4. Controller or motor failure. 	<ol style="list-style-type: none"> 1. Have the battery fully charged; 2. Replace for a new speed regulating handle; 4. Replace for a new power-cut brake handle; 5. Repair or replace the controller or motor.
Short trip distance	<ol style="list-style-type: none"> 1. Battery undercharge; 2. Low tire pressure; 3. Frequent uphill riding or riding against wind, frequent brake, heavy load; 4. Aging or normal degradation of li-ion battery; 5. Friction in braking mechanism; 6. Rotating parts seized up; 7. Normal battery capacity degradation due to low ambient temperature; 8. Continuous riding at a high speed. 	<ol style="list-style-type: none"> 1. Have the battery fully charged; 2. Pump up the tire; 3. Avoid frequent braking, startup or heavy load; 6. Replace for a new set of battery; 5. Adjust the brake; 6. Eliminate seizing-up phenomenon; 7. It is normal; 8. Ride at an intermediate speed.
Battery charge failure	<ol style="list-style-type: none"> 1. Loose connection between the charger plug and battery socket; 2. Battery cable disconnection; 3. Charger failure 	<ol style="list-style-type: none"> 1. Replace the plug/socket; 2. Re-weld the battery cable; 3. Repair the charger or replace for a new one.

Notes

1. Faults listed above have been provided with corresponding solutions. In case the faults cannot be solved following those solutions, please contact our sales department or have it repaired in our after-sale service department. DO NOT disassemble the product arbitrarily.
2. DO NOT disassemble important parts within the warranty period, otherwise they won't be covered by warranty.



After-sale Services

Thanks for purchasing this electric scooter. To protect your lawful rights and identify mutual rights and obligations between you and us during after-sale services and maintenance, please read this warranty statement and keep your warranty card properly.

You will enjoy the after-sale services provided by our designated after-sale service department by the warranty card and purchase invoice.

(1) Scope of after-sale services:

The user is entitled to claim for refund or exchange of the product or repair until the scooter works normally in case of any malfunction or insuperable failure due to quality issues in 7 days since the date of purchase.

(2) Warranty periods for major parts of the portable electric scooter:

Part Name	Warranty Period	Exception	Note
Li-ion battery	Six months	1. Damage due to long-term power lack. 2. Waterlog	Replacement out of the warranty period will be charged at cost price
Controller	One year	1. Waterlog 2. Damage by strong deliberate impact	Replacement out of the warranty period will be charged at cost price
Motor	One year	1. Waterlog 2. Damage by strong deliberate impact	Replacement out of the warranty period will be charged at cost price
Frame, brake handle, disc brake, dashboard, acceleration handle, electronic brake plastic part, tire, LED lights, and other quick-wear parts.	Quick-wear parts are not covered by warranty		Replacement of parts that are not covered by warranty will be charged at cost price

Note:

1. If you find that the scooter you purchase is inconsistent with what is described in the warranty card in 7 days since the date of purchase, please contact your distributor as soon as possible, otherwise we assume no responsibility for any problem as incurred.
2. Any scooter beyond the warranty period shall go through periodical maintenance once every three months in our local after-sale service center; we assume no responsibility for

any problem in the event that you fail to maintain, register or record your scooter periodically.

- Major parts of scooter: battery unit, motors, charger, and controller have been labelled before delivery. Note that those major parts without labels are not covered by warranty.

The following circumstances are not in the scope of free maintenance:

- Consumables and quick-wear parts are not covered by warranty: (LED lights, tires and tubes, the whole set of braking system, plastic parts, brake cable, and cover, etc.);
- Warranted parts that are beyond the warranty period;
- Damages caused by users for not strictly complying with the instructions.
- Damages or quality issues due to accidental impact, crash, and contact with corrosive substance;
- Purchase invoice is inconsistent with the warranty card;
- Parts damaged by unauthorized disassembly or modification, or cases where technical evaluation and analysis cannot be conducted since the initial fault conditions are destroyed due to such unauthorized disassembly or modification.
- By no means should appearance issues be the basis for exchange or warranty once the scooter is sold. Please check the appearance and confirm surface quality carefully in the purchase.
- Damages caused by modifications without the prior consent of our company or our authorized sales and service center.

Warranty Card

Dear user,

Thanks for using our electric scooter. Please fill in the form below clearly for sake of better after-sale services.

User	Name		Workplace	
	Telephone			
	Address			
Date of purchase			Motor serial number	
Model			VIN	
Invoice Number			Battery serial number	
Distributor	Distributor name			
	Contact			
Note				